

GRUNDFOS INSTRUCTIONS

UPS2



be think innovate

GRUNDFOS 

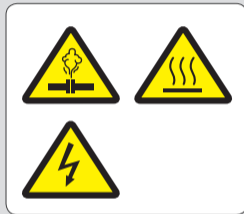



Max. 95 % RH
IP42 



Min./Max.
+2 °C / +95 °C 

Max. 1.0 MPa
(10 bar) 

Min./Max.
0 °C / +40 °C 

< 43 dB(A) 



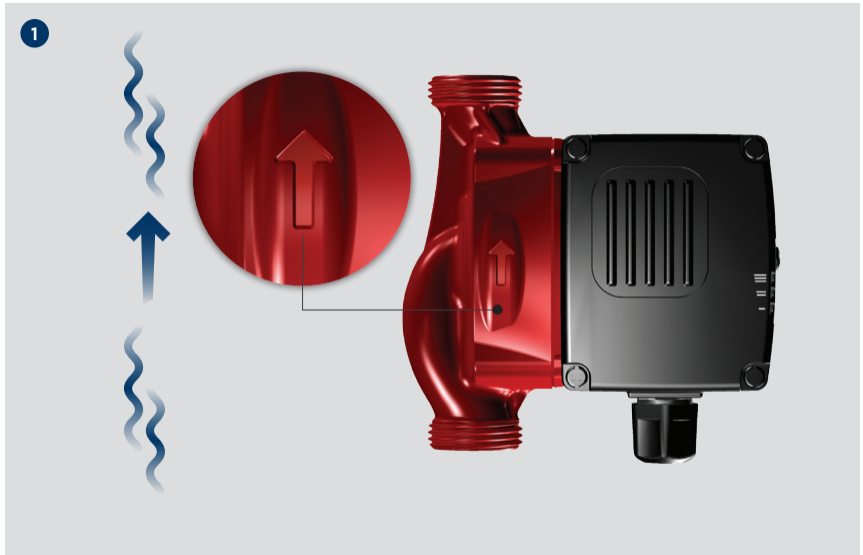
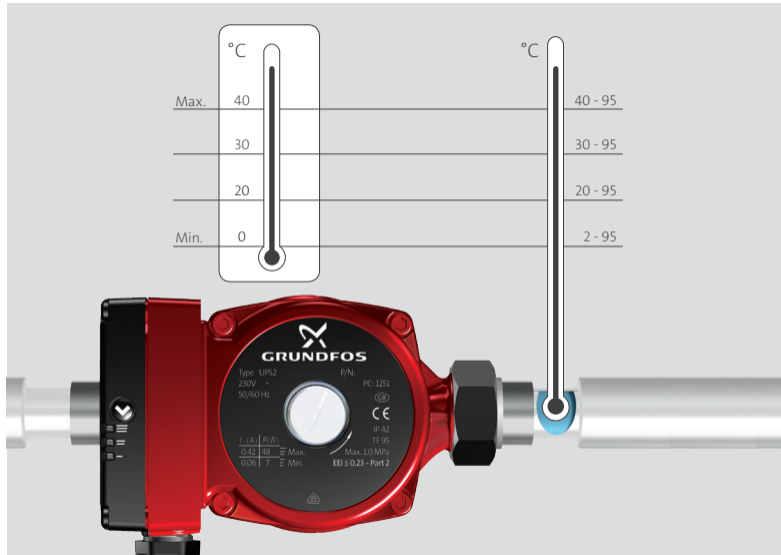

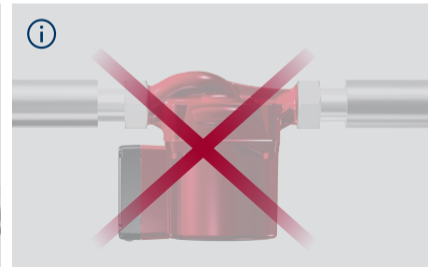
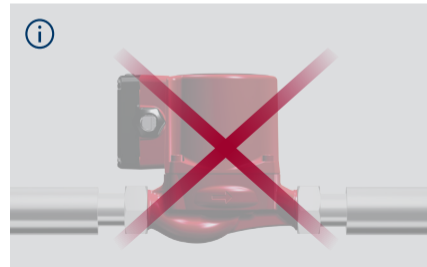



2

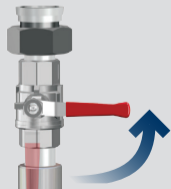
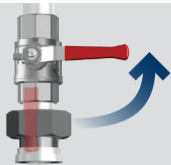

3

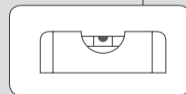
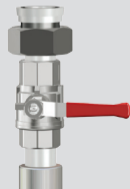
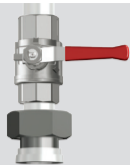

4





5

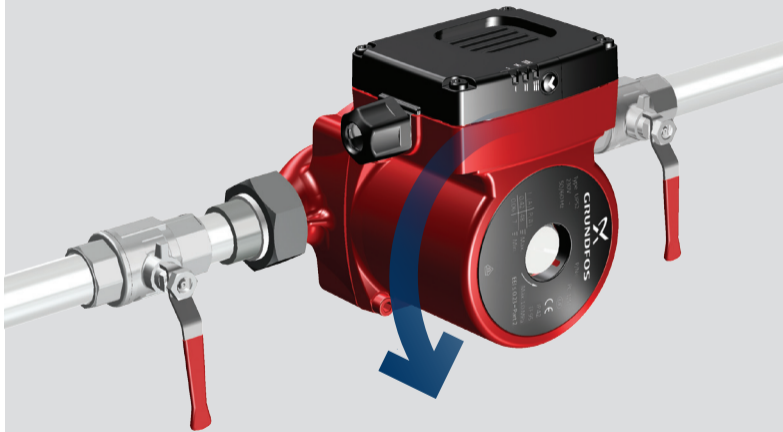

6

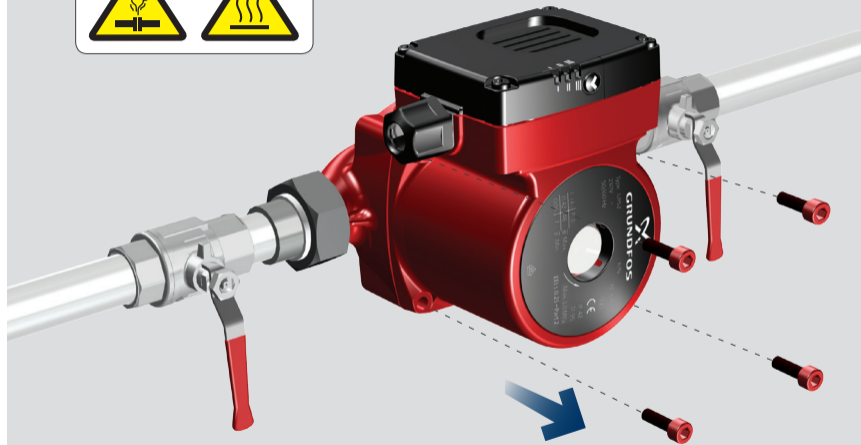

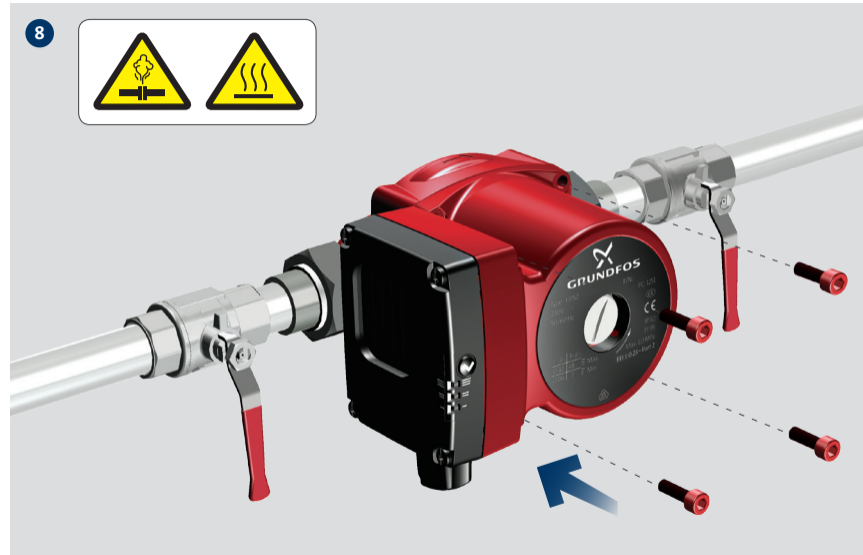
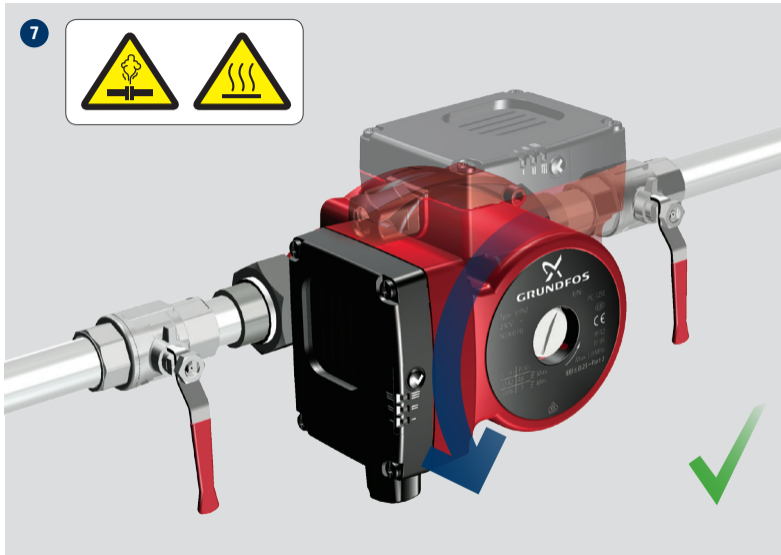



9

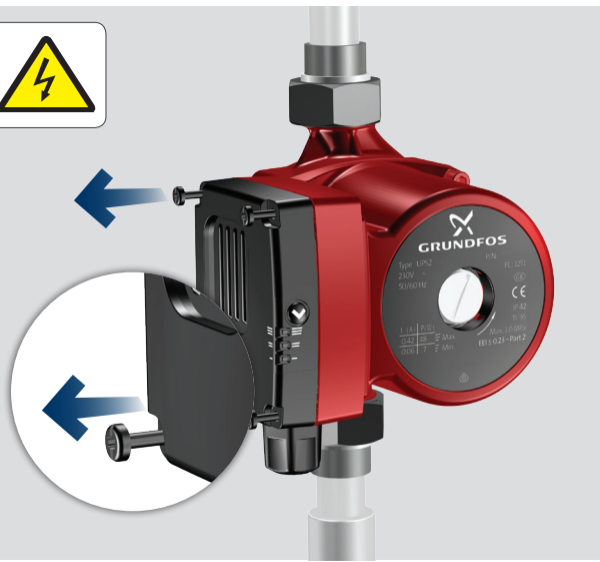

10



11

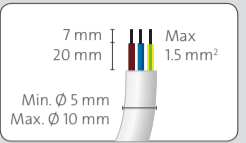



12

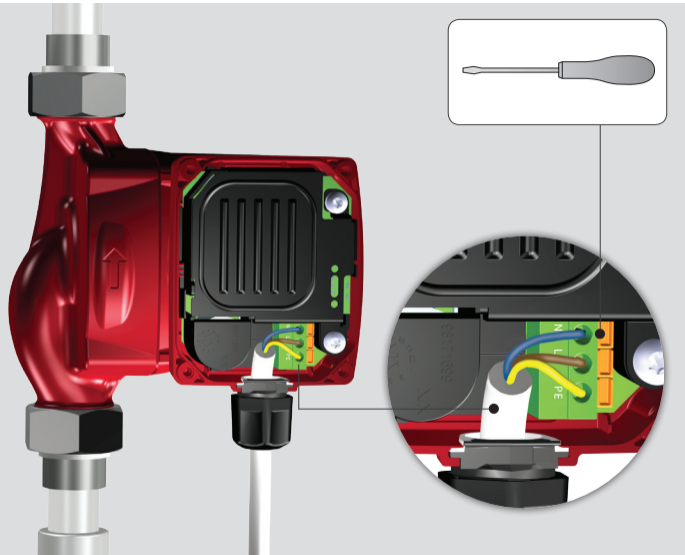

13

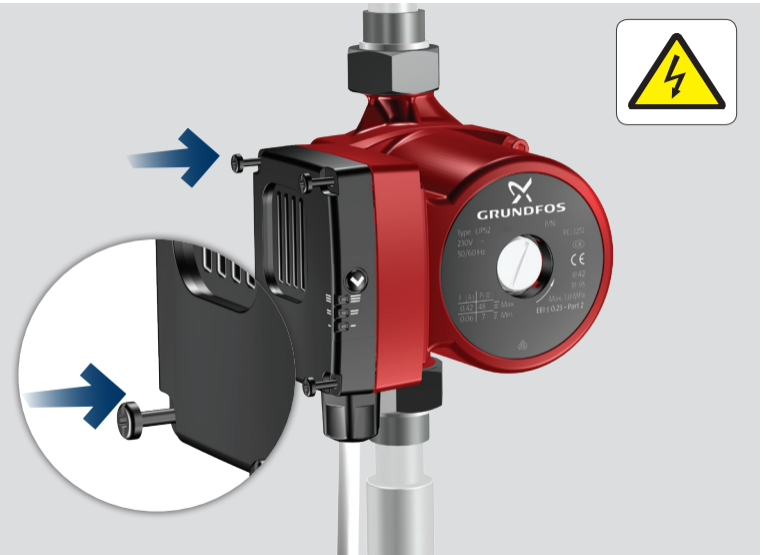



14

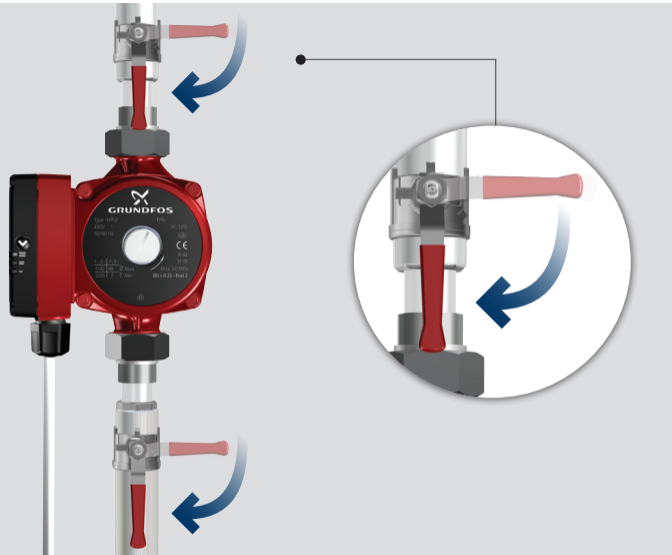

15

1x 230V ± 10%
~50/60 Hz

1- Min. 3 mm
L N



16



17

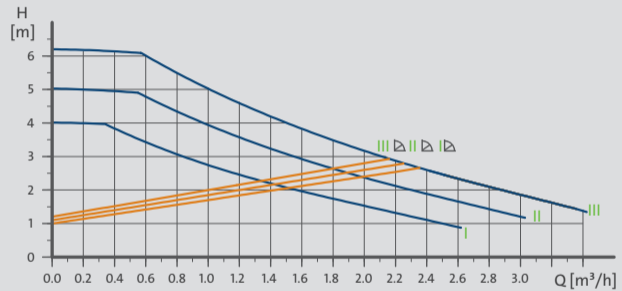

18

■ = III / II / I
 ■ = ▽ III / ▽ II / ▽ I

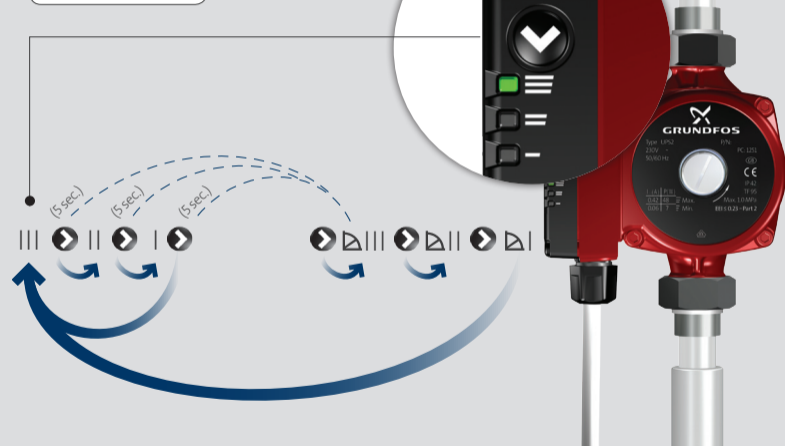

Conversion table

| CURRENT PUMP | SPEED SETTING ON OLD UPS BEING REPLACED | EQUIVALENT SETTING ON NEW UPS2 |
|--------------|-----------------------------------------|--------------------------------|
| 4 m. | All settings: I-II-III | I |
| 5 m. | I | I |
| | II | II |
| | III | II |
| 6 m. | I | I |
| | II | II |
| | III | III |



Product No

| | | |
|------------|------|--------|
| 25*-XX (A) | 3/4" | 529921 |
| 25*-XX (A) | 1" | 529922 |

*= 15 for UK version



Product No

| | | |
|-------|-----|--------|
| 15-XX | 130 | 505821 |
| 25-XX | 130 | |

**GB: EC declaration of conformity**

We, Grundfos, declare under our sole responsibility that the product UPS2, to which this declaration relates, is in conformity with these Council directives on the approximation of the laws of the EC member states:

**ES: Declaración CE de conformidad**

Nosotros, Grundfos, declaramos bajo nuestra propia responsabilidad que el producto UPS2, al cual se refiere esta declaración, está conforme con las Directivas del Consejo en la aproximación de las leyes de los Estados Miembros del EM:

**FR: Déclaration de conformité CE**

Nous, Grundfos, déclarons sous notre seule responsabilité, que le produit UPS2, auquel se réfère cette déclaration, est conforme aux Directives du Conseil concernant le rapprochement des législations des Etats membres CE relatives aux normes énoncées ci-dessous :

**IT: Dichiarazione di conformità CE**

Grundfos dichiara sotto la sua esclusiva responsabilità che il prodotto UPS2, al quale si riferisce questa dichiarazione, è conforme alle seguenti direttive del Consiglio riguardanti il riavvicinamento delle legislazioni degli Stati membri CE:

NL: EC overeenkomstigheidsverklaring

Wij, Grundfos, verklaren geheel onder eigen verantwoordelijkheid dat het product UPS2 waarop deze verklaring betrekking heeft, in overeenstemming is met de Richtlijnen van de Raad in zake de onderlinge aanpassing van de wetgeving van de EG lidstaten betreffende:

PT: Declaração de conformidade CE

A Grundfos declara sob sua única responsabilidade que o produto UPS2, ao qual diz respeito esta declaração, está em conformidade com as seguintes Directivas do Conselho sobre a aproximação das legislações dos Estados Membros da CE:

Low Voltage Directive (2006/95/EC).
Standard used: EN 60335-2-51:2003.
EMC Directive (2004/108/EC).
Standards used: EN 55014-1:2006 and EN 55014-2:1997.
Ecodesign Directive (2009/125/EC).
Circulator pumps:
Commission Regulation No 641/2009 and 622/2012.
Standards used: EN 16297-1:2012 and EN 16297-2:2012.

Bjerringbro, 10th September 2012

Jan Strandgaard
Technical Director
Grundfos Holding A/S
Poul Due Jensens Vej 7
DK-8850 Bjerringbro
Denmark

This EC declaration of conformity is only valid when published as part of these Grundfos installation and operating instructions.

GB: Warning

The use of this product requires experience with and knowledge of the product. Persons with reduced physical, sensory or mental capabilities must not use this product, unless they are under supervision or have been instructed in the use of the product by a person responsible for their safety. Children must not use or play with this product.

ES: Aviso

La utilización de este producto requiere experiencia y conocimiento sobre el mismo. Este producto no debe ser utilizado por personas con capacidades físicas, sensoriales o mentales reducidas, a menos que lo hagan bajo supervisión o hayan recibido instrucciones sobre el uso de este producto de una persona responsable de su seguridad. Los niños no pueden utilizar o jugar con este producto.

FR: Avertissement

L'utilisation de ce produit réclame une certaine expérience et connaissance du produit. Toute personne ayant des capacités physiques, sensorielles ou mentales réduites n'est pas autorisée à utiliser ce produit, à moins qu'elle ne soit surveillée ou qu'elle ait été formée à l'utilisation du produit par une personne responsable de sa sécurité. Les enfants ne sont pas autorisés à utiliser ce produit ni à jouer avec.

IT: Avvertimento

L'utilizzo di questo prodotto richiede una certa esperienza. Le persone con abilità fisiche, sensoriali o mentali ridotte non devono utilizzare questo prodotto a meno che non siano state istruite o siano sotto la supervisione di un responsabile. I bambini non devono utilizzare o giocare con questo prodotto.

NL: Waarschuwing

Het gebruik van dit product vereist ervaring met en kennis van het product. Personen met verminderde lichamelijke, zintuiglijke of geestelijke vermogens mogen dit product niet gebruiken, tenzij ze onder supervisie staan of instructies hebben gekregen over het gebruik van dit product van een persoon die verantwoordelijk is voor hun veiligheid. Kinderen mogen dit product niet gebruiken of ermee spelen.

PT: Aviso

A utilização deste produto requer experiência com o produto e conhecimento do mesmo. Pessoas com capacidades físicas, sensoriais ou mentais reduzidas não devem usar este produto, a menos que estejam sob supervisão ou tenham recebido formação na utilização deste produto pela pessoa responsável pela sua segurança. As crianças não devem utilizar ou brincusul.



Argentina

Bombas GRUNDFOS de Argentina S.A.
Ruta Panamericana, ramal Campana
Centro Industrial Garin - Esq.
Haendely y Mozart
AR-1619 Garin Pcia. de Buenos Aires
Pcia. de Buenos Aires
Phone: +54-3327 414 444

Australia

GRUNDFOS Pumps Pty. Ltd.
PO. Box 2040
Regency Park
South Australia 5942
Phone: +61-8-8461-4611

Austria

GRUNDFOS Pumpen Vertrieb
Ges.m.b.H.
Grundfosstraße 2
A-5082 Grödig/Salzburg
Tel.: +43-6246-883-0

Belgium

N.V. GRUNDFOS Bellux S.A.
Boomssteenweg 81-83
B-2630 Aartselaar
Tel.: +32-3-870 7300
Télécopie: +32-3-870 7301

Belarus

Представительство ГРУНДФОС
в Минске
220123, Минск,
ул. В. Хоружей, 22, оф. 1105
Тел.: +37517) 233 97 65,

Bosnia/Herzegovina

GRUNDFOS Sarajevo
Trg Heroja 16,
BiH-71000 Sarajevo
Phone: +387 33 713 290

Brazil

BOMBAS GRUNDFOS DO BRASIL
Av Humberto de Alencar Castelo
Branco, 630
CEP 09850 - 300
São Bernardo do Campo - SP
Phone: +55-11 4393 5533

Bulgaria

Grundfos Bulgaria EOOD
Slatina District
Iztocna Tangenta street no. 100
BG - 1592 Sofia
Tel. +359 2 49 22 200

Canada

GRUNDFOS Canada Inc.
2941 Brighton Road
Oakville, Ontario
L6H 6C9
Phone: +1-905 829 9533

China

GRUNDFOS Pumps (Shanghai) Co. Ltd.
50/F Maxdo Center No. 8 Xingyi Rd.
Hongqiao development Zone
Shanghai 200336
PRC
Phone: +86 21 612 252 22

Croatia

GRUNDFOS CROATIA d.o.o.
Cebini 37, Buzin
HR-10010 Zagreb
Phone: +385 1 6595 400

Czech Republic

GRUNDFOS s.r.o.
Čajkovského 21
779 00 Olomouc
Phone: +420-585-716 111

Denmark

GRUNDFOS DKA A/S
Martin Bachs Vej 3
DK-8850 Bjerringbro
Tlf: +45-87 50 50 50

Estonia

GRUNDFOS Pumps Eesti OÜ
Peterburi tee 92G
11415 Tallinn
Tel: +372 606 1690

Finland

OY GRUNDFOS Pumput AB
Mestarintie 11
FIN-01730 Vantaa
Phone: +358-3066 5650

France

Pompes GRUNDFOS Distribution S.A.
Parc d'Activités de Chesnes
57, rue de Malacombe
F-38290 St. Quentin Fallavier (Lyon)
Tel.: +33-4 74 82 15 15

Germany

GRUNDFOS GMBH
Schlüterstr. 33
40699 Erkrath
Tel.: +49-(0) 211 929 69-0

HILGE GmbH & Co. KG

Hilgestrasse 37-47
55292 Bodenheim/Rhein
Germany
Tel.: +49 6135 75-0

Greece

GRUNDFOS Hellas A.E.B.E.
20th km. Athinon-Markopoulou Av.
PO. Box 71
GR-19002 Peania
Phone: +0030-210-66 83 400

Hong Kong

GRUNDFOS Pumps (Hong Kong) Ltd.
Unit 1, Ground floor
Siu Wai Industrial Centre
29-33 Wing Hong Street &
68 King Lam Street, Cheung Sha Wan
Kowloon
Phone: +852-27861706 / 27861741

Hungary

GRUNDFOS Hungaria Kft.
Park u. 8
H-2045 Törökbalint,
Phone: +36-23 511 110

India

GRUNDFOS Pumps
India Private Limited
118 Old Mahabalipuram Road
Thoraiakkam
Chennai 600 096
Phone: +91-44 2496 6800

Indonesia

PT GRUNDFOS Pompa
Jl. Rawa Sumur III, Blok III / CC-1
Kawasan Industri, Pulogadung
Jakarta 13900
Phone: +62-21-460 6909

Ireland

GRUNDFOS (Ireland) Ltd.
Unit A, Merrylee Business Park
Ballymount Road Lower
Dublin 12
Phone: +353-1-4089 800

Italy

GRUNDFOS Pompe Italia S.r.l.
Via Gran Sasso 4
I-20060 Truccazzano (Milano)
Tel.: +39-02-95838112

Japan

GRUNDFOS Pumps K.K.
Gotanda Metalion Bldg., 5F,
5-21-15, Higashi-gotanda
Shiagawa-ku, Tokyo
141-0022 Japan
Phone: +81 35 448 1391

Korea

GRUNDFOS Pumps Korea Ltd.
6th Floor, Aju Building 679-5
Yeoksam-dong, Kangnam-ku, 135-916
Seoul, Korea
Phone: +82-2-5317 600

Latvia

SIA GRUNDFOS Pumps Latvia
Deglava biznesa centrs
Augusta Deglava ielā 60, LV-1035, Rīga,
Tālrunis: + 371 714 9640, 7 149 641

Lithuania

GRUNDFOS Pumps LIAB
Smolensko g. 6
LT-03201 Vilnius
Tel: +370 52 395 430

Malaysia

GRUNDFOS Pumps Sdn. Bhd.
7 Jalan Peguam U1/25
Glenmarie Industrial Park
40150 Shah Alam
Selangor
Phone: +60-3-5569 2922

Mexico

Bombas GRUNDFOS
de México S.A. de C.V.
Boulevard TLC No. 15
Parque Industrial Stiva Aeropuerto
Apodaca, N.L. 66600
Phone: +52-81-8144 4000

Netherlands

GRUNDFOS Netherlands
Veluwezoom 35
1326 AE Almere
Postbus 22015
1302 CA ALMERE
Tel.: +31-88-478 6336

New Zealand

GRUNDFOS Pumps NZ Ltd.
17 Beatrice Tinsley Crescent
North Harbour Industrial Estate
Albany, Auckland
Phone: +64-9-415 3240

Norway

GRUNDFOS Pump A/S
Strømsveien 344
Postboks 235, Leirdal
N-1011 Oslo
Tlf: +47-22 90 47 00

Poland

GRUNDFOS Pompy Sp. z o.o.
ul. Klonowa 23
Baranowo k. Poznania
PL-62-081 Przemierowo
Tel: (+48-61) 650 13 00

Portugal

Bombas GRUNDFOS Portugal, S.A.
Rua Calvet de Magalhães, 241
Apartado 1079
P-2770-153 Paço de Arcos
Tel.: +351-21-440 76 00

Romania

GRUNDFOS Pompe România SRL
Bd. Biruintei, nr 103
Pantelimon county Ilfov
Phone: +40 21 200 4100

Russia

ООО Грундфос
Россия, 109544 Москва, ул.
Школьная 39
Тел. (+7) 495 737 30 00, 564 88 00

Serbia

GRUNDFOS Predstavništvo Beograd
Dr. Milutina Ivkovića 2a/29
YU-11000 Beograd
Phone: +381 11 26 47 877 / 11 26 47 496

Singapore

GRUNDFOS (Singapore) Pte. Ltd.
25 Jalan Tukang
Singapore 619264
Phone: +65-6681 9688

Slovenia

GRUNDFOS d.o.o.
Šlandrova 8b, SI-1231 Ljubljana-Črnuče
Phone: +386 1 568 0610

South Africa

GRUNDFOS (PTY) LTD
Corner Mountjoy and
George Allen Roads
Wilbart Ext. 2
Bedfordview 2008
Phone: (+27) 11 579 4800

Spain

Bombas GRUNDFOS España S.A.
Camino de la Fuentequilla, s/n
E-28110 Algete (Madrid)
Tel.: +34-91-848 8800

Sweden

GRUNDFOS AB
Box 333 (Lunnagårdsgatan 6)
431 24 Mölndal
Tel.: +46 31 332 23 000

Switzerland

GRUNDFOS Pumpen AG
Bruggacherstrasse 10
CH-8117 Fällanden/ZH
Tel.: +41-1-806 8111

Taiwan

GRUNDFOS Pumps (Taiwan) Ltd.
7 Floor, 219 Min-Chuan Road
Taichung, Taiwan, R.O.C.
Phone: +886-4-2305 0868

Thailand

GRUNDFOS (Thailand) Ltd.
92 Chaloem Phrakiat Rama 9 Road,
Dokmai, Pravej, Bangkok 10250
Phone: +66-2-725 8999

Turkey

GRUNDFOS POMPA San. ve Tic. Ltd. Sti.
Gebze Organize Sanayi Bölgesi
Wilbart Caddesi,
2. yol 200. Sokak No. 204
41490 Gebze/ Kocaeli
Phone: +90 - 262-679 7979

Ukraine

ТОВ ГРУНДФОС УКРАЇНА
01010 Київ, Вул. Московська 86,
Тел.: +38 044) 390 40 50

United Arab Emirates

GRUNDFOS Gulf Distribution
P.O. Box 16768
Jebel Ali Free Zone
Dubai
Phone: +971 4 8815 166

United Kingdom

GRUNDFOS Pumps Ltd.
Grovebury Road
Leighton Buzzard/Beds. LU7 4TL
Phone: +44-1525-850000

U.S.A.

GRUNDFOS Pumps Corporation
17100 West 118th Terrace
Olathe, Kansas 66061
Phone: +1-913-227-3400

Uzbekistan

Представительство ГРУНДФОС в
Ташкенте
700000 Ташкент ул.Усмана
Носира 1-й
тулик 5
Телефон: (3712) 55-68-15

Revised 27.04.2012

Installation date: _____

Installer:

98289508 0113

ECM: 1106167

be think innovate

GRUNDFOS 

The name Grundfos, the Grundfos logo, and the payoff be think innovate are registered trademarks owned by Grundfos Holding A/S or Grundfos A/S, Denmark. All rights reserved worldwide.