

<b>DE</b>	Gebrauchsanleitung / Montageanleitung	<b>2</b>
<b>FR</b>	Mode d'emploi / Instructions de montage	<b>3</b>
<b>EN</b>	Instructions for use / assembly instructions	<b>4</b>
<b>IT</b>	Istruzioni per l'uso / Istruzioni per Installazione	<b>5</b>
<b>ES</b>	Modo de empleo / Instrucciones de montaje	<b>6</b>
<b>NL</b>	Gebruiksaanwijzing / Handleiding	<b>7</b>
<b>DK</b>	Brugsanvisning / Monteringsvejledning	<b>8</b>
<b>PT</b>	Instruções para uso / Manual de Instalação	<b>9</b>
<b>PL</b>	Instrukcja obsługi / Instrukcja montażu	<b>10</b>
<b>CS</b>	Návod k použití / Montážní návod	<b>11</b>
<b>SK</b>	Návod na použitie / Montážny návod	<b>12</b>
<b>ZH</b>	用户手册 / 组装说明	<b>13</b>
<b>RU</b>	Руководство пользователя / Инструкция по монтажу	<b>14</b>
<b>HU</b>	Használati útmutató / Szerelési útmutató	<b>15</b>
<b>FI</b>	Käyttöohje / Asennusohje	<b>16</b>
<b>SV</b>	Bruksanvisning / Monteringsanvisning	<b>17</b>
<b>LT</b>	Vartotojo instrukcija / Montavimo instrukcijos	<b>18</b>
<b>HR</b>	Upute za uporabu / Uputstva za instalaciju	<b>19</b>
<b>TR</b>	Kullanım kılavuzu / Montaj kılavuzu	<b>20</b>
<b>RO</b>	Manual de utilizare / Instrucțiuni de montare	<b>21</b>
<b>EL</b>	Οδηγίες χρήσης / Οδηγία συναρμολόγησης	<b>22</b>
<b>SL</b>	Navodilo za uporabo / Navodila za montažo	<b>23</b>
<b>ET</b>	Kasutusjuhend / Paigaldusjuhend	<b>24</b>
<b>LV</b>	Lietošanas pamācība / Montāžas instrukcija	<b>25</b>
<b>SR</b>	Uputstvo za upotrebu / Uputstvo za montažu	<b>26</b>
<b>NO</b>	Bruksanvisning / Montasjeveiledning	<b>27</b>
<b>BG</b>	Инструкция за употреба / Ръководство за монтаж	<b>28</b>
<b>SQ</b>	Udhëzuesi i përdorimit / Udhëzime rreth montimit	<b>29</b>
<b>AR</b>	دليل الاستخدام / تعليمات التجميع	<b>30</b>

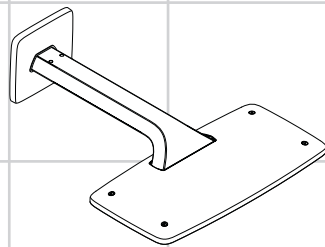

**Raindance E**  
27372000



## Sicherheitshinweise

- ⚠ Bei der Montage müssen zur Vermeidung von Quetsch- und Schnittverletzungen Handschuhe getragen werden.
- ⚠ Das Duschsystem darf nur zur Bade-, Hygiene- und Körperreinigungszwecke eingesetzt werden.
- ⚠ Kinder, sowie Erwachsene mit körperlichen, geistigen und / oder sensorischen Einschränkungen dürfen nicht unbeaufsichtigt das Duschsystem benutzen. Personen die unter Alkohol- oder Drogeneinfluss stehen, dürfen das Duschsystem nicht benutzen.
- ⚠ Der Kontakt der Brausestrahlen mit empfindlichen Körperstellen (z. B. Augen) muss vermieden werden. Es muss ein ausreichender Abstand zwischen Brause und Körper eingehalten werden.
- ⚠ Der Kopfbrausearm ist nur für das Halten der Kopfbrause ausgelegt, er darf nicht mit weiteren Gegenständen belastet werden!

## Montagehinweise

- Vor der Montage muss das Produkt auf Transportschäden untersucht werden. Nach dem Einbau werden keine Transport- oder Oberflächenschäden anerkannt.
- Die Leitungen und die Armatur müssen nach den gültigen Normen montiert, gespült und geprüft werden.
- Die in den Ländern jeweils gültigen Installationsrichtlinien sind einzuhalten.
- Bei der Montage des Produktes durch qualifiziertes Fachpersonal ist darauf zu achten, dass die Befestigungsfläche im gesamten Bereich der Befestigungsplan ist (keine vorstehenden Fugen oder Fliesenversatz), der Wandaufbau für eine Montage des Produktes ge
- Dieses Produkt kann nicht in Verbindung mit hydraulisch und thermisch gesteuerten Durchlauferhitzern eingesetzt werden.

## Technische Daten

Betriebsdruck: max. 0,6 MPa  
 Empfohlener Betriebsdruck: 0,1 - 0,4 MPa  
 (1 MPa = 10 bar = 147 PSI)  
 Heißwassertemperatur: max. 60°C

## Symbolerklärung



Mitte Duschwanne



Warmwasser



Kaltwasser



Kein essigsäurehaltiges Silikon verwenden!



In diesem Bereich ist eine Wandverstärkung notwendig.



Unterputz-Ventil



Quattro Vierwegeumstellung

Quattro



Trio Universal Absperr- und Umstellventil

Trio



Der nicht benötigte Abgang muss mit einem Blindstopfen abgedichtet werden.



> 50 l/min

Die Ablaufleistung muss mehr als 50 l/min betragen.



Ablauf



Maße (siehe Seite 31)



Durchflussdiagramm (siehe Seite 33)



Service Teile (siehe Seite 36)



Reinigung (siehe Seite 37 - 38) und beiliegende Broschüre







Prüfzeichen (siehe Seite 39)



## Montage siehe Seite 31



## Consignes de sécurité

-  Lors du montage, porter des gants de protection pour éviter toute blessure par écrasement ou coupure.
-  Le système de douche ne doit servir qu'à se laver et à assurer l'hygiène corporelle.
-  Il est interdit aux enfants ainsi qu'aux adultes ayant des insuffisances physiques, psychiques et/ou motoriques d'utiliser la douche sans surveillance. De même, il est interdit à des personnes sous influence d'alcool ou de drogues d'utiliser la douche.
-  Éviter le contact du jet de la douchette avec les parties sensibles du corps (telles par ex. que les yeux). Veiller à respecter un écart suffisant entre la douchette et le corps
-  Le bras de la douchette n'est conçu que pour tenir la douchette et ne doit pas servir à la suspension d'autres objets !















## Instructions pour le montage

- Avant son montage, s'assurer que le produit n'a subi aucun dommage pendant le transport. Après le montage, tout dommage de transport ou de surface ne pourra pas être reconnu.
- Les conduites et la robinetterie doivent être montés, rincés et contrôlés selon les normes en vigueur.
- Les directives d'installation en vigueur dans le pays concerné doivent être respectées.
- Lors du montage du produit par un ouvrier qualifié, il faut faire attention à ce que la surface de fixation soit plane sur toute son étendue (aucun dépassement de joint ni de carrelage), que la construction de la paroi soit adaptée à l'installation du pro
- Les mitigeurs Hansgrohe ne doivent pas être utilisées avec des chauffe-eau instantané à commande hydraulique ou thermique.

## Informations techniques

Pression de service autorisée: max. 0,6 MPa  
 Pression de service conseillée: 0,1 - 0,4 MPa  
 (1 MPa = 10 bar = 147 PSI)  
 Température d'eau chaude: max. 60°C

## Description du symbole

-  Centre cuvette de douche
-  Eau chaude
-  Eau froide
-  Ne pas utiliser de silicone contenant de l'acide acétique!
-  Le mur n'a pas besoin d'être renforcé à cet endroit
-  Robinet d'arrêt encastré
-  Quattro inverseur quatre voies
- Quattro**  
 Trio Robinet d'arrêt avec inverseur
- Trio**  
 La sortie non utilisée doit être condamnée avec un bouchon laiton.
-  Le débit de vidage doit être supérieur à 50 l/min.
- > 50 l/min**  
 Vidage
- Raindrain**  

-  **Dimensions** (voir page 31)  
**Diagramme du débit** (see page 33)
-  **Pièces détachées** (voir pages 36)
-  **Nettoyage** (voir page 37 - 38) et brochure ci-jointe
-  **Classification acoustique et débit** (voir page 39)



**Montage voir page 31**



## Safety Notes

- ⚠️ Gloves should be worn during installation to prevent crushing and cutting injuries.
- ⚠️ The shower system may only be used for bathing, hygienic and body cleansing purposes.
- ⚠️ Children as well as adults with physical, mental and/or sensoric impairments must not use this shower system without proper supervision. Persons under the influence of alcohol or drugs are prohibited from using this shower system.
- ⚠️ Do not allow the streams of the shower touch sensitive body parts (such as your eyes). An adequate distance must be kept between the shower and you.
- ⚠️ The arm of the shower head is intended only to hold the shower head. Do not load it down with other objects!

## Installation Instructions

- Prior to installation, inspect the product for transport damages. After it has been installed, no transport or surface damage will be honoured.
- The pipes and the fixture must be installed, flushed and tested as per the applicable standards.
- The plumbing codes applicable in the respective countries must be observed.
- Where the contractor mounts the product, he should ensure that the entire area of the wall to which the mounting plate is to be fitted, is flat (no projecting joints or tiles sticking out), that the structure of the wall is suitable for the installation.
- This mixer cannot be used in conjunction with hydraulically, electronically or thermally controlled instantaneous heaters.

## Technical Data

Operating pressure:	max. 0,6 MPa
Recommended operating pressure:	0,1 - 0,4 MPa
(1 MPa = 10 bar = 147 PSI)	
Hot water temperature:	max. 60°C

## Symbol description





-  Center shower tub
-  Warm water
-  Cold water
-  Do not use silicone containing acetic acid!
-  The wall must be reinforced in this area.
-  Shut off valve
-  Quattro 4-Way Diverter Valve
- Quattro**  
 Trio 2-Way Diverter Valve with integrated Shut-off valve
- Trio**  
 La sortie non utilisée doit être condamnée avec un bouchon laiton.
-  The waste drain performance must be more than 50 l/min.
- > 50 l/min**  
 Waste
- Dimensions** (see page 31)
- Flow diagram** (see page 33)
- Spare parts** (see page 36)
-  **Cleaning** (see page 37 - 38) and enclosed brochure
-  **Test certificate** (see page 39)



**Assembly see page 31**



## Indicazioni sulla sicurezza

-  Durante il montaggio, per evitare ferite da schiacciamento e da taglio bisogna indossare guanti protettivi.
-  Il sistema doccia deve essere utilizzato esclusivamente per l'igiene del corpo.
-  I bambini e gli adulti affetti da menomazioni fisiche, psichiche e/osensoriali devono utilizzare il sistema della doccia solo sotto la supervisione di una persona responsabile.
-  Bisogna evitare il contatto fra il getto della doccia e parti del corpo delicate (ad es. gli occhi). Fra il soffione ed il corpo va mantenuta una distanza sufficiente.
-  Il braccio del soffione della doccia è progettato per sostenere solo quest'ultimo, non va sovraccaricato con altri oggetti!

















## Istruzioni per il montaggio

- Prima del montaggio è necessario controllare che non ci siano stati danni durante il trasporto. Una volta eseguito il montaggio, non verranno riconosciuti eventuali danni di trasporto o delle superfici.
- Montare, lavare e controllare tubature e rubinetteria rispettando le norme correnti.
- Vanno rispettate le direttive di installazione nazionali vigenti nel rispettivo paese.
- Quando il personale tecnico specializzato esegue il montaggio del prodotto è necessario assicurarsi che la superficie di fissaggio sia piana in tutta l'area di fissaggio (senza giunti sporgenti o spostamento delle piastrelle), che la struttura della parete
- I miscelatori non sono compatibili con le caldaie istantanee.

## Dati tecnici

Pressione d'uso:	max. 0,6 MPa
Recommended operating pressure:	0,1 - 0,4 MPa
(1 MPa = 10 bar = 147 PSI)	
Temperatura dell'acqua calda:	max. 60 °C

## Descrizione simbolo

-  Centro piatto doccia
-  Acqua calda
-  Acqua fredda
-  Non utilizzare silicone contenente acido acetico!
-  In questa zona è necessario un rinforzo della parete.
-  Rubinetto di arresto
-  Quattro Valvola a quattro vie
- Quattro**  
 Trio arresto/deviatore
- Trio**  
 Chiudere con un tappo l'uscita non utilizzata.
-  La portata di scarico deve essere superiore a 50 l/min.
- > 50 l/min**  
 Scarico
- Raindrain**  
 **Ingombri** (vedi pagg. 31)
-  **Diagramma flusso** (vedi pagg. 33)
-  **Parti di ricambio** (vedi pagg. 36)
-  **Pulitura** (vedi pagg. 37 - 38) e brochure allegata
-  **Segno di verifica** (vedi pagg. 39)





## Indicaciones de seguridad

- ⚠ Durante el montaje deben utilizarse guantes para evitar heridas por aplastamiento o corte.
- ⚠ El sistema de ducha solo debe ser utilizado para fines de baño, higiene y limpieza corporal.
- ⚠ Niños, así como adultos con limitaciones corporales, mentales y/o sensoriales no deben utilizar el sistema de duchas sin vigilancia. Personas que se encuentran bajo el efecto de alcohol o drogas, no deben utilizar el sistema de duchas.
- ⚠ Debe evitarse el contacto del chorro del pulverizador con partes sensibles del cuerpo (por ej. ojos). Debe mantenerse una distancia suficiente entre pulverizador y cuerpo.
- ⚠ El brazo del pulverizador de ducha solo está previsto para soportar el pulverizador de ducha. No debe cargarse con otros objetos!

## Indicaciones para el montaje

- Antes del montaje se debe examinarse el producto contra daños de transporte. Después de la instalación so se reconoce ningún daño de transporte o de superficie.
- Los conductos y la grifería deben montarse, lavarse y comprobarse según las normas vigentes.
- Es obligatorio el cumplimiento de las directrices de instalación vigentes en el país respectivo.
- En el momento del montaje del producto por parte de personal especializado y cualificado se deberá prestar una atención especial a que la superficie de fijación en toda el área de la fijación sea plana (sin juntas que sobresalen ni azulejos desplazados),
- Los mezcladores no pueden usarse con calentadores instantáneos mandados hidráulicamente o térmicamente.

## Datos técnicos

Presión en servicio:	max. 0,6 MPa
Presión recomendada en servicio: (1 MPa = 10 bar = 147 PSI)	0,1 - 0,4 MPa
Temperatura del agua caliente:	max. 60 °C

## Descripción de símbolos



Centro la plato de ducha



Agua caliente



Agua fría



No utilizar silicona que contiene ácido acético!



En este sector es necesario un refuerzo del muro.



Llave de paso



Quattro Valvola a quattro vie

Quattro



Trio llave de paso y distribuidor

Trio



La salida que no se utiliza debe ser tapada.



> 50 l/min

El caudal de desagüe debe ser como mínimo de 50 l/min



Desagüe



**Dimensiones** (ver página 31)



**Diagrama de circulación**  
(ver página 33)



**Repuestos** (ver página 36)



**Limpiar** (ver página 37 - 38) y folleto anexo



**Marca de verificación** (ver página 39)





## Veiligheidsinstructies

- ⚠ Bij de montage moeten ter voorkoming van knel- en snijwonden handschoenen worden gedragen.
- ⚠ Het douchesysteem mag alleen voor het wassen, hygiënische doeleinden en voor de lichaamsreiniging worden gebruikt.
- ⚠ Kinderen en volwassenen met lichamelijke, geestelijke en/of sensorische beperkingen mogen het douchesysteem niet zonder toezicht gebruiken. Personen onder invloed van alcohol of drugs mogen het douchesysteem niet gebruiken.
- ⚠ Het contact van de douchestraal met gevoelige lichaamsdelen (bijv. ogen) moet worden voorkomen. Er moet voldoende afstand tussen douche en lichaam aangehouden worden.
- ⚠ De arm van de hoofddouche is uitsluitend voor het vasthouden van de hoofddouche bedoeld en mag niet met verdere voorwerpen worden belast!

## Montage-instructies

- Vóór de montage moet het product gecontroleerd worden op transportschade. Na de inbouw wordt geen transport- of oppervlakteschade meer aanvaard.
- De leidingen en armaturen moeten gemonteerd, gespoeld en gecontroleerd worden volgens de geldige normen.
- De in de overeenkomstige landen geldende installatierichtlijnen moeten nageleefd worden.
- Bij de montage van het produkt door een vakkundige installateur moet men erop letten dat het bevestigingsoppervlak op één oppervlak zit (dus geen opliggende voegen of verspringende tegels), de wand geschikt is voor montage van produkten en zeker geen zwak
- Hansgrohe kranen mogen niet in verbinding met hydraulische en thermisch gestuurde geisers geplaatst worden.

## Technische gegevens

Werkdruk: max.	max. 0,6 MPa
Aanbevolen werkdruk: (1 MPa = 10 bar = 147 PSI)	0,1 - 0,4 MPa
Temperatuur warm water:	max. 60°C

## Symboolbeschrijving

-  Midden Douchebak
-  Warm water
-  Koud water
-  Gebruik geen zuurhoudende silicone!
-  In dit bereik is een wandversterking noodzakelijk.
-  Inbouwstopkraan
-  Quattro 4-weg omstelkraan
- Quattro**
-  Trio stop- en omstelkraan
- Trio**
-  De niet benodigde uitgang moet met een blindstop worden afgedicht.
-  De afvoercapaciteit moet meer dan 50 l/min bedragen.
- > 50 l/min**
-  Afvoer
- Raindrain**
-  **Maten** (zie blz. 31)
-  **Doorstroomdiagram** (zie blz. 33)
-  **Service onderdelen** (zie blz. 36)
-  **Reinigen** (zie blz. 37 - 38) en bijgevoegde brochure
-  **Keurmerk** (zie blz. 39)



**Montage zie blz. 31**



## Sikkerhedsanvisninger

- △ Ved monteringen skal der bruges handsker for at undgå kvæstelser og snitsår.
- △ Bruserystemet må kun bruges til bade-, hygiejne og rengøringsformål.
- △ Børn som også voksne med fysiske, mentale og / eller sensoriske begrænsninger må ikke bruge bruserystemet uden opsyn. Personer som er under indflydelse af alkohol eller narkotika må ikke bruge bruserystemet.
- △ Bruserstrålekontakt med sensitive områder (f.eks. øjne) skal undgås. Der skal være en tilstrækkelig afstand mellem bruseren og kroppen.
- △ Stangen til hovedbruseren er kun beregnet til at holde hovedbruseren. Den må ikke belastes med andre genstande!

















## Monteringsanvisninger

- Før monteringen skal produktet kontrolleres for transportskader. Efter monteringen godkendes transportskader eller skader på overfladen ikke længere.
- Ledningerne og armaturerne skal monteres, skylles og kontrolleres iht. de gældende standarder.
- Installationsbestemmelserne, der gælder i det enkelte land, skal overholdes.
- Ved montering er det vigtigt at sikre sig, at hele befæstigelsesfladen er plan (ingen ujævne fuger eller fliser), samt at væggen er egnet til montering af produktet og specielt, at væggen ikke har nogen svage punkter. De medfølgende skruer og dübler er ku
- Hansgrohe armaturer kan ikke anvendes i forbindelse med hydraulisk og termisk styrede vandvarmere.

## Tekniske data

Driftstryk:	max. 0,6 MPa
Anbefalet driftstryk:	0,1 - 0,4 MPa
(1 MPa = 10 bar = 147 PSI)	
Varmtvandstemperatur:	max. 60°C





## Symbolbeskrivelse

-  Midt brusekar
-  Varmt vand
-  Kold vand
-  Der må ikke benyttes eddikesyreholdig silikone!
-  I dette område er en forstærkning af væggen nødvendig.
-  Afspæringsventil
-  Quattro 4-vejs ventil
- Quattro**
-  Trio afspæringsventil og omskifter
- Trio**
-  Afgangen, der ikke benyttes, skal afproppes.
-  Afløbskapaciteten skal være mere end 50 l/min.
- > 50 l/min**
-  Afløb
- Raindrain**
-  **Målene** (se s. 31)
-  **Gennemstrømningsdiagram** (se s. 33)
-  **Reserve dele** (se s. 36)
-  **Rengøring** (se s. 37 - 38) og vedlagt brochure
-  **Godkendelse** (se s. 39)





## Avisos de segurança

-  Durante a montagem devem ser utilizadas luvas de protecção, de modo a evitar ferimentos resultantes de entalamentos e de cortes.
-  O sistema de duche só pode ser utilizado para fins de higiene pessoal.
-  Crianças e adultos com deficiências motoras, mentais e/ou sensoriais não podem utilizar o sistema de duche sem monitorização. Pessoas que estejam sob a influência de álcool ou drogas não podem utilizar o sistema de duche.
-  Deve-se evitar o contacto dos jactos de água com partes do corpo sensíveis (p. ex. olhos). É necessário manter uma distância suficiente entre o chuveiro e o corpo.
-  O braço do chuveiro foi concebido apenas para servir de apoio à cabeça do chuveiro, pelo que não pode ser sujeito a cargas de objectos adicionais!

















## Avisos de montagem

- Antes da montagem deve-se controlar o produto relativamente a danos de transporte. Após a montagem não são aceites quaisquer danos de transporte ou de superfície.
- As tubagens e a torneira têm que ser montadas, enxaguadas e verificadas de acordo com as normas em vigor.
- A prescrições de instalação válidas nos respetivos países devem ser respeitadas.
- Durante a montagem do produto por técnicos qualificados, deve ter-se em atenção que a superfície de fixação seja plana em toda a área da fixação (sem juntas sobrepostas/salientes ou ladrilhos deslocados), que o dispositivo de montagem na parede seja adequado.
- As misturadoras não são compatíveis com o uso de esquentadores instantâneos hidráulicos, electrónicos ou térmicos.

## Dados Técnicos

Pressão de funcionamento:	max. 0,6 MPa
Pressão de func. recomendada:	0,1 - 0,4 MPa
(1 MPa = 10 bar = 147 PSI)	
Temperatura da água quente:	max. 60°C





## Descrição do símbolo

-  Meio da base de duche
-  Água quente
-  Água fria
-  Não utilizar silicone que contenha ácido acético!
-  Nesta zona é necessário um reforço na parede.
-  Torneira de passagem
-  Quatro válvula de diversão de 4 vias
- Quattro**
-  Trio universal inversor/válvula de corte
- Trio**
-  Tamponar a saída não utilizada.
-  Capacidade de escoamento tem que ser superior a 50 l/min.
- > 50 l/min**
-  **Raindrain**
-  Escóamento
- Medidas** (ver página 31)
-  **Fluxograma** (ver página 33)
-  **Peças de substituição** (ver página 36)
-  **Limpeza** (ver página 37 - 38) e brochura em anexo
-  **Marca de controlo** (ver página 39)





## Wskazówki bezpieczeństwa

-  Aby uniknąć zranień, takich jak zgniecenia czy przecięcia, podczas montażu należy nosić rękawice.
-  Prysznic może być używany tylko w celach kąpieli, higieny i utrzymania czystości ciała.
-  Zarówno dzieci, jak i dorośli z fizycznymi, psychicznymi i/lub sensorycznymi ograniczeniami nie mogą korzystać z prysznica bez opieki. Osoby znajdujące się pod wpływem alkoholu lub narkotyków nie mogą korzystać z prysznica.
-  Należy unikać kontaktu strumienia wyływającego z głowicy z wrażliwymi częściami ciała (np. oczami). Należy zachowywać odpowiednią odległość pomiędzy głowicą a ciałem.
-  Ramię prysznica jest przystosowane do trzymania głowicy prysznica i nie może być obciążane innymi przedmiotami!

















## Wskazówki montażowe

- Przed montażem należy skontrolować produkt pod kątem szkód transportowych. Po montażu nie widać żadnych szkód transportowych ani szkód na powierzchni.
- Przewody i armatura muszą być montowane, płukane i kontrolowane według obowiązujących norm.
- Należy przestrzegać wytycznych instalacyjnych obowiązujących w danym kraju.
- Przy montażu produktu przez wykwalifikowany personel fachowy należy zważać na to, by powierzchnia mocowania na całym obszarze mocowania była równa (by nie było szczelin wzgl. wzajemnie przesuniętych płytek), rodzaj ściany nadawał się do montażu produktu i
- Armatura Hansgrohe może być wykorzystywana w połączeniu z hydraulicznie, elektronicznie i termicznie sterowanym ogrzewaczem przepływowym.

## Dane techniczne

Ciśnienie robocze: maks. 0,6 MPa  
 Zalecane ciśnienie robocze: 0,1 - 0,4 MPa  
 (1 MPa = 10 bary = 147 PSI)  
 Temperatura wody gorącej: maks. 60°C

## Opis symbolu

-  Środek brodzika
-  Ciepła woda
-  Zimna woda
-  Nie stosować silikonów zawierających kwas octowy!
-  W tym obszarze konieczne jest wzmocnienie ściany.
-  Zawór podtynkowy
-  Regulator czterodrożny Quattro
- Quattro**
-  Zawór odcinający i regulacyjny Trio Universal
- Trio**
-  Niewykorzystany wylot należy zakorkować dołożonym w dostawie korkiem.
-  Wydajność odpływu musi być wyższa niż 50 l/min.
- > 50 l/min**
-  Odpływ
- Raindrain**
-  **Wymiary** (patrz strona 31)
-  **Schemat przepływu** (patrz strona 33)
-  **Części serwisowe** (patrz strona 36)
-  **Czyszczenie** (patrz strona 37 - 38) i dołączona broszura
-  **Znak jakości** (patrz strona 39)



## Montaż patrz strona 31



## **Bezpečnostní pokyny**

- ⚠ Pro zabránění řezným zraněním a pohmožděninám je nutné při montáži nosit rukavice.
- ⚠ Sprchový systém smí být používán pouze ke koupání a za účelem tělesné hygieny.
- ⚠ Děti a dospělé osoby s tělesným, duševním a / nebo smyslovým postižením nesmí sprchový systém používat bez dozoru. Osoby pod vlivem alkoholu nebo drog nesmí sprchový systém používat.
- ⚠ Je nutné zabránit kontaktu vodních paprsků sprchy s měkkými částmi těla (např. očima). Je nutné dodržovat dostatečný odstup mezi sprchou a tělem.
- ⚠ Držák sprchové hlavice je dimenzován pouze pro držení sprchové hlavice a nesmí se zatěžovat dalšími předměty!















## **Pokyny k montáži**

- Před montáží je třeba produkt zkontrolovat, zda nebyl při transportu poškozen. Po zabudování nebudou uznány žádné škody způsobené transportem nebo poškození povrchu.
- Vedení a armatura musí být namontovány, propláchnuty a otestovány podle platných norem.
- Je třeba dodržovat montážní pravidla platná v dané zemi.
- Při montáži produktu kvalifikovaným odborným personálem je třeba dbát na to, aby upevňovací plochy byly v celém rozsahu upevnění rovné (žádné vyčnívající spáry nebo navzájem přesazené obklady), aby konstrukce stěny byla pro montáž produktu vhodná a zvlášť
- Tento produkt nemůže být používán ve spojení s hydraulicky a teplotně řízenými průtokovými ohřivači.

## **Technické údaje**

Provozní tlak:	max. 0,6 MPa
Doporučený provozní tlak: (1 MPa = 10 bar = 147 PSI)	0,1 - 0,4 MPa
Teplota horké vody:	max. 60°C

## **Popis symbolů**





-  Střed sprchové vany
-  Teplá voda
-  Studená voda
-  Nepoužívat silikon s obsahem kyseliny octové!
-  V této oblasti je potřebné zesílení stěny.
-  Podomítkový uzavírací ventil
-  Quattro čtyřcestné přestavování
- Quattro**
-  Trio Universal - Uzavírací a přepínací ventil
- Trio**
-  Nepoužitý vývod musí být utěsněn zasleповací zátkou.
-  Odtokový výkon musí být vyšší než 50 l/min.
- > 50 l/min**
-  **Raindrain**  
Odtok
- Rozměry** (viz strana 31)
-  **Diagram průtoku**  
(viz strana 33)
-  **Servisní díly** (viz strana 36)
-  **Čištění** (viz strana 37 - 38) a přiložená brožura
-  **Zkušební značka** (viz strana 39)



## **Montáž viz strana 31**



## **Bezpečnostné pokyny**

-  Pri montáži musíte nosiť rukavice, aby ste predišli pomliaždeninám a rezným poraneniam.
-  Sprchovací systém sa smie používať len na kúpanie a telesnú hygienu.
-  Sprchovací systém nesmú bez dozoru používať deti, ako aj dospelé osoby s telesným, duševným a/alebo zmyslovým postihnutím. Sprchovací systém nesmú používať ani osoby, ktoré sú pod vplyvom alkoholu alebo drog.
-  Vyhýbajte sa kontaktu vodného lúča sprchy s citlivými miestami tela (napr. oči). Dodržiavajte dostatočnú vzdialenosť medzi sprchou a telom.
-  Rameno držiaka hlavice sprchy je určené len na uchytenie hlavice sprchy a nesmie sa zaťažovať inými predmetmi!

















## **Pokyny pre montáž**

- Pred montážou musíte produkt skontrolovať, či nebol počas transportu poškodený. Po zabudovaní nebudú uznané žiadne škody spôsobené transportom alebo poškodenia povrchu.
- Ledningarna och blandaren måste monteras, spolars igenom och kontrolleras enligt de gällande normerna.
- Je potrebné dodržiavať smernice o inštalácii, ktoré sú práve teraz platné v krajinách.
- Pri montáži produktu kvalifikovaným odborným personálom je nutné dbať na to, aby upevňovacie plochy boli v celom rozsahu upevnenia rovné (žiadne vyčnievajúce škáry alebo navzájom predsadené obklady), aby konštrukcia steny bola pre montáž produktu vhodná a
- Tento produkt sa nesmie používať v spojení s hydraulicky a teplotne riadenými prietokovými ohrievačmi.

## **Technické údaje**

Prevádzkový tlak:	max. 0,6 MPa
Doporučený prevádzkový tlak: (1 MPa = 10 bar = 147 PSI)	0,1 - 0,4 MPa
Teplota teplej vody:	max. 60 °C

## **Popis symbolov**

-  Stred sprchovej vane
-  Teplá voda
-  Studená voda
-  Nepoužívať silikón s obsahom kyseliny octovej!
-  V tejto oblasti je potrebné zosilnenie steny.
-  Podomietkový uzatvárací ventil
-  Quattro štvorcestné prestavenie
- Quattro**  
 Trio univerzálny uzatvárací a prestavovací ventil
- Trio**  
 Nepoužitý vývod musí byť zaslepený zátkou.
-  Výkon odtoku musí byť vyšší ako 50 l/min.
-  **> 50 l/min**
-  Odtok
-  **Rozmery** (viď strana 31)
-  **Diagram prietoku** (viď strana 33)
-  **Servisné diely** (viď strana 36)
-  **Čistenie** (viď strana 37 - 38) a priložená brožúra
-  **Osvedčenie o skúške** (viď strana 39)





## 安全技巧

- △ 装配时为避免挤压和切割受伤，必须戴上手套。
- △ 淋浴系统只允许作为洗浴、卫生和洁身之用。
- △ 不得让儿童和肢体、精神和/或意识有障碍的成人在不受监管的情况下使用淋浴系统。受酒精或毒品影响的人员不得使用淋浴系统。
- △ 必须避免让身体敏感部位（如眼睛）接触到莲蓬头喷水。必须保持莲蓬头与人头之间有足够的距离。
- △ 头顶莲蓬头夹持杆只为夹持头顶莲蓬头而设计，不得让其承载其它物品！

## 安装提示

- 安装前必须检查产品是否受到运输损害。安装后将不认可运输损害或表面损伤。
- 管道和阀门必须根据通用标准进行安装、冲洗和检查。
- 请遵守当地国家现行的安装规定。
- 在安装产品的位置，安装人员必须确保安装面的墙面是平的（没有突出物或瓷砖没有突起），墙体结构适合产品的安装并没有弱点。包装内的膨胀螺丝只适用于混凝土墙体。对于其他墙体结构必须咨询膨胀螺丝生产商的建议。
- 该产品不可与液控和热控即热式热水器连接使用。

## 技术参数

工作压强: 最大 0,6 MPa  
 推荐工作压强: 0,1 0,4 MPa  
 (1 MPa = 10 bar = 147 PSI)  
 热水温度: 最大 60° C

## 符号说明

-  中心淋浴盆
-  热水
-  冷水
-  请勿使用含有乙酸的硅！
-  该区域需要一个加固边壁。
-  截止阀
-  Quattro 四通转换器
-  通用的三通截止阀和换向阀
-  插入不使用的插座。
-  排水功率必须大于 50 l/min.
-  > 50 l/min
-  排水口
-  大小 (参见第 31 页)
-  流量示意图 (参见第 33 页)
-  备用零件 (参见第 36 页)
-  清洗 (参见第 37 - 38 页) 并附有小手册
-  检验标记 (参见第 39 页)



安装 参见第 31 页



## Указания по технике безопасности

- ⚠ Во время монтажа следует надеть перчатки во избежание прищемления и порезов.
- ⚠ Душевую систему разрешается использовать только в гигиенических целях для принятия ванны и личной гигиены.
- ⚠ Дети, а также взрослые с физическими, умственными и/или сенсорными недостатками должны пользоваться душевой системой только под присмотром. Запрещается пользоваться душевой системой в состоянии алкогольного или наркотического опьянения.
- ⚠ Не допускайте попадания струи воды из разбрызгивателя на чувствительные части тела (например, на глаза). Разбрызгиватель следует устанавливать на достаточном расстоянии от тела.
- ⚠ Кронштейн верхнего душа предназначен только для подсоединения верхнего душа. Запрещается подвешивать на него другие предметы!

## Указания по монтажу

- Перед монтажом следует проверить изделие на предмет повреждений при перевозке. После монтажа претензии о возмещении ущерба за повреждения при перевозке или повреждения поверхности не принимаются.
- Трубы и арматура должны быть установлены, промыты и проверены в соответствии с действующими нормами.
- Необходимо соблюдать требования по монтажу, действующие в соответствующих странах.
- При монтаже изделия квалифицированным персоналом необходимо следить за тем, чтобы, поверхность крепления была плоской во всей зоне крепления (без выступающих швов или смещения плитки), структура стен подходила для монтажа изделия и, в частности, не имела
- Применение этой продукции при наличии гидравлических и проточных нагревателей с тепловой регулировкой не допускается.















## Технические данные

Рабочее давление: не более, 0,6 МПа  
 Рекомендуемое рабочее давление: 0,1 – 0,4 МПа  
 (1 МПа = 10 bar = 147 PSI)  
 Температура горячей воды: не более, 60°C







# Монтаж см. стр. 31

## Описание символов

-  Середина душевой ванны
-  Теплая вода
-  Холодная вода
-  Не применяйте силикон, содержащий уксусную кислоту.
-  В этой области требуется укрепление стены.
-  Скрытый вентиль
-  Четырехходовой переключатель Quattro
- Quattro**
-  Трехходовой запорный и переключающий вентиль Trio Universal
- Trio**
-  Ненужный выход необходимо уплотнить с помощью заглушки.
-  Слив должен иметь производительность более 50 л/мин.
- > 50 l/min**
-  Слив
- Raindrain**
- Размеры** (см. стр. 31)
-  **Схема потока** (см. стр. 33)
-  **Комплект** (см. стр. 36)
-  **Очистка** (см. стр. 37 - 38) и прилагаемая брошюра
-  **Знак технического контроля** (см. стр. 39)



## Biztonsági utasítások

-  A szerelésnél a zúzódások és vágási sérülések elkerülése érdekében kesztyűt kell viselni.
-  A zuhanyrendszert csak fürdéshez, mosakodáshoz és egészségügyi tisztálkodáshoz szabad használni.
-  Gyermekek, valamint testileg, szellemileg fogyatékos vagy érzékelésben korlátozott személyek nem használhatják felügyelet nélkül a zuhanyrendszert. Alkohol és kábítószer befolyása alatt álló személyek nem használhatják a zuhanyrendszert.
-  Kerülni kell a zuhansugár érintkezését érzékeny testrészekkel (pl. szemek). Be kell tartani a megfelelő távolságot a zuhanyfej és a test között.
-  A zuhanyfej karja csak a zuhanyfej tartására alkalmas, és nem szabad más tárgyakkal megterhelni!

















## Szerelési utasítások

- A szerelés előtt ellenőrizni kell, hogy a terméknek nincs-e szállítási sérülése. Beépítés után a szállítási-vagy felületi sérüléseket nem ismerik el.
- A vezetékeket és a csaptelepet az érvényes szabványoknak megfelelően kell felszerelni, öblíteni és ellenőrizni
- Az egyes országokban érvényes installációs irányelveket be kell tartani.
- Miközben szakképzett szakember végzi a termék felszerelését, ügyelni kell arra, hogy a rögzítési felületek a rögzítési terület teljes egészén síkok (nincsenek kiálló fugák vagy csempezélek), a fal felépítése alkalmas a termék felszereléséhez, és különösk
- Ha a zuhany működik, akkor ennek a zuhanykarral együtt kb. 10 kg a tömege. Ezért csak a falnak megfelelő rögzítő anyagot szabad használni! A mellékelt csavarok és tiplik csak tömör falakhoz használhatók.

## Műszaki adatok

Üzemi nyomás:	max. 0,6 MPa
Ajánlott üzemi nyomás:	0,1 - 0,4 MPa
(1 MPa = 10 bar = 147 PSI)	
Forróvíz hőmérséklet:	max. 60°C

## Szimbólumok leírása

-  Zuhanytálca közepe
-  Melegvíz
-  Hidegvíz
-  Ne használjon ecetsavtartalmú szilikon!
-  Ezen a területen a fal megerősítésére van szükség.
-  Falsík alatti szelep
-  Quattro négy-utas átalakító
- Quattro**
-  Trio univerzális záró- és váltószelep
- Trio**
-  A főlsleges kimenetet vakdugóval kell lezárni.
-  A lefolyó teljesítményének 50l/percnél magasabbnak kell lenni
- > 50 l/min**
-  Lefolyó
- Raindrain**
-  **Méretet** (lásd a 31. oldalon)
-  **Átfolyási diagramm** (lásd a 33. oldalon)
-  **Tartozékok** (lásd a 36. oldalon)
-  **Tisztítás** (lásd a 37 - 38. oldalon) és mellékelt bróssúrával
-  **Vizsgajel** (lásd a 39. oldalon)



**Szerelés lásd a 31. oldalon**



## Turvallisuusohjeet

- Asennuksessa on käytettävä käsineitä puristumien ja viiltojen aiheuttamien tapaturmien estämiseksi.
- Suihkujärjestelmää saa käyttää ainoastaan kylpy-, hygienia- ja puhdistustarkoituksiin.
- Lapset ja ruumiillisesti, henkisesti ja/tai aistillisesti rajoittuneet aikuiset eivät saa käyttää suihkujärjestelmää ilman valvontaa. Alkoholin tai huumeiden vaikutuksessa olevat henkilöt eivät saa käyttää suihkujärjestelmää.
- Suihkuveden kontaktia herkempien ruumiinosien (esim. silmien) kanssa on vältettävä. Suihkun ja vartalon välissä on oltava riittävä väli.
- Pääsuihkun varsi on tarkoitettu vain kannattamaan pääsuihkua. Sitä ei saa kuormittaa muilla esineillä!

## Asennusohjeet

- Ennen asennusta on tarkastettava tuotteen mahdolliset kuljetusvahingot. Asennuksen jälkeen kuljetus- ja pintavaurioita ei hyväksytä.
- Putket ja hana on asennettava, huuhdeltava ja tarkastettava voimassa olevien standardien mukaisesti.
- Jokaisessa maassa on noudatettava siellä päteviä asennusohjeita.
- Kun pätevä ammattihenkilöstö suorittaa tuotteen asennusta, on huomioitava, että kiinnityspinta on koko kiinnityksen alueella tasainen (ei ulkonevia saumoja tai laattojen tasomuutoksia) ja, että seinän rakenne soveltuu tuotteen asentamiseen eikä siinä ole
- Tätä tuotetta ei voi käyttää hydraulisesti tai termiterisesti ohjattujen läpivirtauskuumentimien yhteydessä.

## Tekniset tiedot

Käyttöpaine:	maks. 0,6 MPa
Suosittelut käyttöpaine:	0,1 - 0,4 MPa
(1 MPa = 10 bar = 147 PSI)	
Kuuman veden lämpötila:	maks. 60 °C

## Merkin kuvaus



Suihkualtaan keskusta



Lämmin vesi



Kylmä vesi



Älä käytä etikkahappopitoista silikonia!



Tässä kohdassa seinää on vahvistettava



Upotettava venttiili



4-tiesäätöventtiili

**Quattro**



Trio -sulku- ja säätöventtiili

**Trio**



Käyttämätön lähtöliitin on suljettava sulku-tulpalla.



> 50 l/min

Poisvirtaustehon on oltava enemmän kuin 50l/min.



**Raindrain**

Veden poisvirtaus

**Mitat** (katso sivu 31)



**Virtausdiagrammi**  
(katso sivu 33)



**Varaosat** (katso sivu 36)



**Puhdistus** (katso sivu 37 - 38) ja oheinen esite



**Koestusmerkki** (katso sivu 39)



## Asennus katso sivu 31



## ! Säkerhetsanvisningar

- △ Handskar ska bäras under monteringsarbetet så att man kan undvika kläm- och skärskadorgen werden.
- △ Duschsystemet får bara användas till kroppshygien med bad och dusch.
- △ Barn samt vuxna med fysiska, psykiska eller sensoriska funktionshinder får inte använda duschsystemet ensamma. Personer som är påverkade av alkohol eller droger får inte använda duschsystemet.
- △ Undvik att rikta duschstrålarna mot känsliga kroppsdelar (t. ex. ögonen. Det måste finnas ett tillräckligt stort avstånd mellan duschen och kroppen.
- △ Armen som håller huvudduschen är bara konstruerad för detta; den får inte belastas med andra föremål!

















## Monteringsanvisningar

- Det måste undersökas om produkten har transportskador innan den monteras. Efter monteringen accepteras inga transport- eller ytskiktsskador.
- Ledningarna och blandaren måste monteras, spolas igenom och kontrolleras enligt de gällande normerna.
- De installationsriktlinjer som gäller i länderna ska följas.
- När kvalificerad fackpersonal monterar produkten är det viktigt att tänka på att monteringsytan är plan i alla delar av arbetsytan (inga fogar som sticker ut eller klinkerförskjutningar), att väggkonstruktionen passar till montering av produkten samt att
- Denna produkt kan inte användas tillsammans med hydrauliskt och termiskt styrda varmvattenberedare.

## Tekniska data

Driftstryck:	max. 0,6 MPa
Rek. driftstryck:	0,1 – 0,4 MPa
(1 MPa = 10 bar = 147 PSI)	
Varmvattentemperatur:	max. 60 °C

## Simbolio aprašymas

-  Mitten av duschkaret
-  Varmvatten
-  Kallvatten
-  Använd inte silikon som innehåller ättiksyra!
-  Šioje zonoje būtinas sienos sutvirtinimas
-  Invändig ventil
-  Quattro Fyrvägsmkastare
- Quattro**
-  Trio Universell avstängningsventil och omkastare
- Trio**
-  Det utlopp som inte behövs måste tätas med en blindstopp.
-  Avloppet måste klara mer än 50 l/min.
- > 50 l/min**
-  Avlopp
- Raindrain**
-  **Måtten** (se sidan 31)
-  **Flödesschema** (se sidan 33)
-  **Reservdelar** (se sidan 36)
-  **Rengöring** (se sidan 37 - 38) och medföljande broschyr
-  **Testsigill** (se sidan 39)





## Saugumo technikos nurodymai

- ⚠️ Apsaugai nuo užspaudimo ir įsijovimo montavimo metu mūvėkite pirštines.
- ⚠️ Dušo sistema turi būti naudojama tik kūno higienai ir švarai palaikyti.
- ⚠️ Dušo sistema uždrausta naudotis vaikams, taip pat suaugusiems su fizine, dvasine negale ir (arba) sensorikos sutrikimais. Dušo sistema taip pat uždrausta naudotis asmenims, apsvaigusiems nuo alkoholio arba narkotikų.
- ⚠️ Būtina vengti dušo vandens srovės kontakto su jautriomis kūno vietomis (pvz., akimis). Todėl būtina laikytis tinkamu atstumu nuo dušo.
- ⚠️ Dušo laikiklis skirtas tik dušo galvutei laikyti, todėl neturi būti apkraunamas kitokiais daiktais!

















## Montavimo instrukcija

- Prieš montuojant būtina patikrinti, ar gaminyje nebuvo pažeistas transportavimo metu. Sumontavus pretenzijos dėl transportavimo ir paviršiaus pažeidimų nepriimamos.
- Vamzdžiai ir sujungimai turi būti montuojami, plaunami ir tikrinami pagal galiojančias normas.
- Laikykitės atitinkamoje šalyje galiojančių direktyvų dėl įrengimo.
- Montuojant produktą, specialistas privalo įsitikinti, kad sienos plotas, prie kurio dedama montavimo plokštė, yra lygus (jokių plytelių ar kitų nelygumų), kad sienos struktūra yra pritaikyta produkto montavimui ir neturi jokių silpnų vietų. Pakuotėje esan
- Šio produkto negalima naudoti kartu su hidrauliškai ir termiškai valdomu tekančio vandens šildytuvu.

## Techniniai duomenys

Darbinis slėgis: ne daugiau kaip 0,6 MPa  
 Rekomenduojamas slėgis: 0,1 – 0,4 MPa  
 (1 MPa = 10 barų = 147 PSI)  
 Karšto vandens temperatūra: ne daugiau kaip 60 °C

## Simbolio aprašymas

-  Dušo padėklo centras
-  Šiltas vanduo
-  Šaltas vanduo
-  Nenaudokite silikono, kurio sudėtyje yra acto rūgšties!
-  Šioje zonoje būtinas sienos sutvirtinimas
-  Potinkinis uždarymo vožtuvas
-  „Quattro“ 4-krypčių perjungimas
-  Užtvarinis ir perjungimo vožtuvas „Trio Universal“
-  Nenaudojamą išėjimą užaklinti.
-  Nutekėjimo našumas turi būti ne mažesnis 50 l/min
-  Nutekėjimas
-  **Išmatavimai** (žr. psl. 31)
-  **Pralaidumo diagrama** (žr. psl. 33)
-  **Atsarginės dalys** (žr. psl. 36)
-  **Valymas** (žr. psl. 37 - 38) ir pridedama brošiūra
-  **Bandymo pažyma** (žr. psl. 39)





## Sigurnosne upute

- ⚠ Prilikom montaže se radi sprječavanja prignječenja i posjekotina moraju nositi rukavice.
- ⚠ Sustav tuša se smije primjenjivati samo za kupanje, tuširanje i osobnu higijenu.
- ⚠ Djeca, kao i tjelesno, mentalno i/ili senzorno hendikepirane odrasle osobe ne smiju se koristiti sustavom tuša bez nadzora. Osobe koje su pod utjecajem alkohola ili droga ne smiju se koristiti sustavom tuša.
- ⚠ Mora se izbjegavati kontakt mlaza iz tuša s osjetljivim dijelovima tijela (npr. očima). Tijelo korisnika mora biti dovoljno udaljeno od tuša.
- ⚠ Nosač tuša iznad glave je dimenzioniran samo za držanje danog tuša i ne smije se opterećivati drugim predmetima!

















## Upute za montažu

- Prije montaže mora se provjeriti je li proizvod oštećen prilikom transporta. Nakon ugradnje se ne priznaju nikakve reklamacije koje se odnose na površinska i transportna oštećenja.
- Cijevi i armatura moraju biti postavljeni, isprani i testirani prema važećim normama.
- Obvezno se moraju uvažiti propisi o instalacijama koji vrijede u dotičnoj zemlji.
- Kada proizvod montira kvalificirano stručno osoblje treba paziti da čitava površina na koju se učvršćuje bude ravna (bez istaknutih fuga ili krivljenja pločica), da je zidna konstrukcija primjerena montaži proizvoda te osobito da nema slabih mjesta. Prilo
- Ovaj proizvod se ne može rabiti uz hidraulički i termički regulirane protočne bojlere.

## Tehnički podaci

Najveći dopušteni tlak: tlak 0,6 MPa  
 Preporučeni tlak: 0,1 – 0,4 MPa  
 (1 MPa = 10 bar = 147 PSI)  
 Temperatura vruće vode: tlak 60 °C

## Opis simbola

-  Sredina tuš-kada
-  topla voda
-  hladna voda
-  Nemojte koristiti silikon koji sadrži octenu kiselinu!
-  U ovom je području potrebno ojačanje zida.
-  Podžbukni ventil
-  Quattro četverostruki preusmjerač
- Quattro**  
 Trio Universal ventil za zatvaranje i ventil selektora
- Trio**  
 Potrebno je ostaviti zatvoren izlaz koji se ne koristi
-  Protok vode mora biti veći od 50 l/min.
- > 50 l/min**  
 Odvod
- Raindrain**
-  **Mjere** (pogledaj stranicu 31)
-  **Dijagram protoka** (pogledaj stranicu 33)
-  **Rezervni dijelovi** (pogledaj stranicu 36)
-  **Čišćenje** (pogledaj stranicu 37 - 38) i priložena brošura
-  **Oznaka testiranja** (pogledaj stranicu 39)



## Sastavljanje pogledaj stranicu 31



## ⚠ Güvenlik uyarıları

- ⚠ Montaj esnasında ezilme ve kesilme gibi yaralanmaları önlemek için eldiven kullanılmalıdır.
- ⚠ Duş sistemi yalnızca banyo, hijyen ve beden temizliği amaçları doğrultusunda kullanılabilir.
- ⚠ Bedensel, ruhsal ve/veya sensörük engelli çocuk ve yetişkinler gözetimsiz olarak duş sistemini kullanmamalıdır. Alkol veya uyuşturucu etkisinde olanlar duş sistemini kullanmamalıdır.
- ⚠ Püskürtme başlıklarının hassas organlara teması (örn. gözler) önlenmelidir. Püskürtücü ile beden arasında yeterli mesafe bırakılmalıdır.
- ⚠ Başlıklı püskürtücü kolu yalnızca başlıklı püskürtücünün tutulması için tasarlanmıştır, başka nesnelere üzerine yük bindirilmemelidir!

## Montaj açıklamaları

- Montaj işleminden önce ürün nakliye hasarları yönünden kontrol edilmelidir. Montaj işleminden sonra nakliye veya yüzey hasarları için sorumluluk üstlenilmemektedir.
- Boruların ve armatürün montajı, yıkanması ve kontrolü geçerli normlara göre yapılmalıdır.
- Ülkelerde geçerli kurulum yönetmeliklerine riayet edilmelidir.
- Müteahhit, ürünü monteleyeceği yer, yani montaj plakasının monte edileceği duvar alanının tümü düz (herhangi bir eklem yerinin ya da duvar fayansının çıkıntısıyla) engellenmemiş, yapısı ürünü montelemeye uygun bir şekilde ve herhangi zayıf noktası olamama
- Bu ürün hidrolik ve termik kumandalı akış ısıtıcılarıyla bağlantılı olarak kullanılmamalıdır.

## Teknik bilgiler

İşletme basıncı: azami 0,6 MPa  
Tavsiye edilen işletme basıncı: 0,1 – 0,4 MPa  
(1 MPa = 10 bar = 147 PSI)  
Sıcak su sıcaklığı: azami 60 °C

## Simge açıklaması



Duş küvetinin ortası



Sıcak su



Soğuk su



Asetik asit içeren silikon kullanmayın!



Bu alanda duvarın kalınlaştırılması gereklidir.



Sıva altı valfi



Quattro dört yönlü değiştirme

**Quattro**



Trio üniversal kapatma ve değiştirme valfi



**Trio**



> 50 l/min



Akış kapasitesi 50 l/dak üzerinde olmalıdır.

Akış



**Ölçüleri** (Bakınız sayfa 31)



**Akış diyagramı**  
(Bakınız sayfa 33)



**Yedek Parçalar**  
(Bakınız sayfa 36)



**Temizleme** (Bakınız sayfa 37 - 38)  
ve birlikte verilen broşür







**Kontrol işareti** (Bakınız sayfa 39)





## Instrucțiuni de siguranță

-  La montare utilizați mănuși pentru evitarea contuziunilor și tăierii mâinilor.
-  Sistemul de duș poate fi utilizat doar pentru spălarea, menținerea igienei și curățarea corpului.
-  Copiii și adulții cu dizabilități corporale, mintale și senzoriale nu pot utiliza sistemul de duș nesupravegheați. De asemenea este interzisă utilizarea sistemului de duș de către persoane, care se află sub influența alcoolului sau a drogurilor.
-  Evitați contactul jetului de apă cu părțile de corp sensibile (de ex. ochii). Țineți dușul la o distanță corespunzătoare de corp.
-  Brațul parei de duș este destinat doar pentru a susține para, acesta nu poate fi prevăzut cu alte obiecte.

















## Instrucțiuni de montare

- Înainte de instalare verificați, dacă produsul prezintă deteriorări de transport. După instalare garanția nu acoperă deteriorările de transport și cele de suprafață.
- Conductele și bateriile trebuie montate, spălate și verificate conform normelor în vigoare.
- Respectați reglementările referitoare la instalare valabile în țara respectivă.
- La montarea produsului de către un personal calificat trebuie să fiți atenți ca suprafața, unde se fixează produsul să fie plată pe toată suprafața utilizată (să nu existe rosturi sau faianțe proeminente), peretele să fie adecvat pentru montarea produsului
- Acest produs nu poate fi utilizat în combinație cu boilerle cu flux continuu hidraulice sau comandate termic.

## Date tehnice

Presiune de funcționare:	max. 0,6 MPa
Presiune de funcționare recomandată:	0,1 - 0,4 MPa (1 MPa = 10 bar = 147 PSI)
Temperatura apei calde:	max. 60°C

## Descrierea simbolurilor

-  În mijlocul căzii de duș
-  Apă caldă
-  Apă rece
-  Nu utilizați silicon cu conținut de acid acetic!
-  În această zonă este nevoie de întărirea peretelui.
-  Ventil montat sub tencuială
-  Quattro valvă de inversare cu patru căi
- Quattro**
-  Trio valvă de închidere și de inversare universală
- Trio**
-  Racordurile neutilizate trebuie acoperite cu dop etanș.
-  Capacitatea de evacuare trebuie să fie mai mare de 50 l/min.
- > 50 l/min**
-  **Raindrain**
-  **Dimensiuni** (vezi pag. 31)
-  **Diagrama de debit** (vezi pag. 33)
-  **Piese de schimb** (vezi pag. 36)
-  **Curățare** (vezi pag. 37 - 38) și broșura alăturată
-  **Certificat de testare** (vezi pag. 39)



**Montare vezi pag. 31**



## ⚠ Υποδείξεις ασφαλείας

- ⚠ Για να αποφύγετε τραυματισμούς κατά τη συναρμολόγηση πρέπει να φοράτε γάντια.
- ⚠ Το σύστημα ντους επιτρέπεται να χρησιμοποιείται μόνο σαν μέσο λουτρού, υγιεινής και καθαρισμού του σώματος.
- ⚠ Παιδιά ή ενήλικες με μειωμένες σωματικές, διανοητικές και/ή αισθητήριες ανεπάρκειες δεν επιτρέπεται να χρησιμοποιούν το σύστημα ντους χωρίς επίτηρηση. Άτομα υπό την επήρεια οινοπνεύματος ή ναρκωτικών δεν επιτρέπεται να χρησιμοποιούν σε καμία περίπτωση το
- ⚠ Η επαφή δέσμης νερού του ντους με ευαίσθητες περιοχές του σώματος (π.χ. μάτια) πρέπει να αποφεύγεται. Διατηρείτε επαρκή απόσταση ανάμεσα στο ντους και το σώμα.
- ⚠ Ο βραχιόνιος του ντους κεφαλιού έχει μελετηθεί μόνο για να κρατά το ντους κεφαλιού, δεν επιτρέπεται να φορτίζεται με άλλα αντικείμενα!

## Οδηγίες συναρμολόγησης

- Πριν τη συναρμολόγηση πρέπει να εξεταστεί το προϊόν για ζημιές μεταφοράς. Μετά την εγκατάσταση δεν αναγνωρίζονται ζημιές από τη μεταφορά ή επιφανειακές ζημιές.
- Οι σωλήνες και η μπαταρία πρέπει να τοποθετηθούν σύμφωνα με τα ισχύοντα πρότυπα, να τεθούν υπό πίεση και να δοκιμαστούν.
- Θα πρέπει να τηρούνται οι οδηγίες εγκατάστασης που ισχύουν σε κάθε κράτος.
- Κατά τη συναρμολόγηση του προϊόντος από καταρτισμένο και εξειδικευμένο προσωπικό θα πρέπει να δοθεί προσοχή, ώστε η επιφάνεια στερέωσης στη συνολική περιοχή στερέωσης να είναι επίπεδη (να μην υπάρχουν προεξέχοντες αρμοί ή λιθογόμωση πλακιδίων), ώστε η κατ
- Αυτό το προϊόν δεν μπορεί να χρησιμοποιηθεί σε συνδυασμό με υδραυλικούς και θερμικά ελεγχόμενους ταχυθερμοσίφωνες.

## Τεχνικά Χαρακτηριστικά

Λειτουργία πίεσης:

Συνιστώμενη λειτουργία πίεσης:  
(1 MPa = 10 bar = 147 PSI)

Θερμοκρασία ζεστού νερού:

έως 0,6 MPa

0,1 - 0,4 MPa

έως 60 °C

## Περιγραφή συμβόλων



Μέσον της ντουσιέρας



Ζεστό νερό



Κρύο νερό



Μην χρησιμοποιείτε σιλικόνη που περιέχει οξικό οξύ!



Σε αυτήν την περιοχή είναι απαραίτητη μία ενίσχυση του τοίχου.



Χωνευτή βαλβίδα



Quattro τετράοδης μετατροπής

Quattro



Trio

Trio Universal βαλβίδα κλεισίματος και εκτροπής



Τα περιττά στόμια εξόδου πρέπει να στεγανοποιηθούν με ένα τυφλό πώμα.



> 50 l/min

Η αποχευτική ικανότητα της βαλβίδας εκροής πρέπει να υπερβαίνει τα 1/min.



Raindrain

Βαλβίδα εκροής

**Διαστάσεις** (βλ. σελίδα 31)



**Διάγραμμα ροής**  
(βλ. σελίδα 33)



**Ανταλλακτικά** ( βλ. σελίδα 36 )



**Καθαρισμός** (βλ. σελίδα 37 - 38)  
και συνημμένο φυλλάδιο



**Σήμα ελέγχου** (βλ. σελίδα 39)





## Varnostna opozorila

- ⚠ Pri montaži je treba nositi rokavice, da se preprečijo poškodbe zaradi zmečkanja ali urezov.
- ⚠ Sistem za prhanje se sme uporabljati le z namenom umivanja, vzdrževanja higiene in telesne nege.
- ⚠ Otroci kot tudi odrasle osebe z omejenimi telesnimi, duševnimi in/ali senzoričnimi sposobnostmi ne smejo nenadzorovano uporabljati sistema za prhanje. Osebe, ki so pod vplivom alkohola ali drog, sistema za prhanje ne smejo uporabljati.
- ⚠ Izogibati se je treba stiku prhalnega curka z občutljivimi deli telesa (npr. očmi). Med telesom in prho mora biti vedno zadosten razmik.
- ⚠ Le bras de la douchette n'est conçu que pour tenir la douchette et ne doit pas servir à la suspension d'autres objets !



















## Navodila za montažo

- Pred montažo je treba izdelek preveriti glede morebitnih transportnih poškodb. Po vgradnji transportne ali površinske poškodbe ne bodo več priznane.
- Cevi in armaturo je treba montirati, izprati in preveriti po veljavnih standardih.
- Upoštevati je treba pravilnike o inštalacijah, ki veljajo v posamezni državi.
- Kamorkoli bo pogodbenik namestil izdelek, mora poskrbeti, da je celotno območje stene na katero bo ploščica nameščena ravno (brez štrlečih fug ali robov ploščic), ter da je struktura stene primerna za namestitev in je brez šibkih točk. Priloženi vijaki in l
- Tega proizvoda ni možno uporabiti v povezavi s hidravlično in termično krmljenimi pretočnimi grelniki.

## Tehnični podatki

Delovni tlak:	maks. 0,6 MPa
Priporočeni delovni tlak: (1 MPa = 10 bar = 147 PSI)	0,1 - 0,4 MPa
Temperatura tople vode:	maks. 60 °C

## Opis simbola

-  Sredina pršne kadi
-  Topla voda
-  Mrzla voda
-  Ne smete uporabiti silikona, ki vsebuje očetno kislino!
-  V tem območju je potrebno ojačanje stene.
-  Podometni ventil
-  Quattro 4tiripotna prestavitev
-  Trio Universal zaporni in preklopni ventil
-  Trio
-  Izhod, ki ga ne potrebujete, zatesnite s čepom.
-  Odtočna kapacitetamora znašati več kot 50 l/min.
-  > 50 l/min  
Odtok
-  Raindrain
-  **Mere** (glejte stran 31)
-  **Diagram pretoka** (glejte stran 33)
-  **Rezervni deli** (glejte stran 36)
-  **Čiščenje** (glejte stran 37 - 38) in priložena brošura
-  **Preskusni znak** (glejte stran 39)



**Montaža Glejte stran 31.**



## ⚠ Ohutusjuhised

- ⚠ Kandke paigaldamisel muljumis- ja löikevigastuste vältimiseks kindaid.
- ⚠ Dušisüsteemi tohib kasutada ainult pesemis-, hügieeni- ja kehapuhastamisesmärkidel.
- ⚠ Lapsed, samuti kehaliste, vaimsete või tajupiirangutega täiskasvanud ei tohi dušisüsteemi järelvalveta kasutada. Alkoholi või narkootikumide mõju all olevad isikud ei tohi dušisüsteemi kasutada.
- ⚠ Duši veejoad ei tohi kokku puutuda tundlike kehahäädadega (nt silmad). Jätke duši ja keha vahele piisav vahet.
- ⚠ Dušiipea hoidik on mõeldud ainult dušiipea hoidmiseks ja seda ei tohi muude esemetega koormata!

## Paigaldamisjuhised

- Enne paigaldamist tuleb toodet kontrollida transpordikahjustuste osas. Pärast paigaldamist ei tunnustata enam transpordi- või pinnakahjustuste kaebuseid.
- Voolikute ja segisti paigaldamisel, loputamisel ja kontrollimisel tuleb lähtuda kehtivatest normatiividest.
- Vastavas riigis kehtivaid paigalduseeskirju tuleb järgida.
- Toote paigaldamisel peab töövõtja tagama, et kogu seinapind, kuhu paigaldusplaat kinnitatakse, on lame (ükski vuuk ega keraamiline plaat ei ulatu esile), ning et seina konstruktsioon on toote paigaldamiseks sobiv ja sellel puuduvad nõrgad kohad. Kaasasole
- Seda toodet ei saa kasutada koos hüdrauliliselt ja termiliselt juhitava läbivoolusoojendiga.

## Tehnilised andmed

Töörõhk	maks. 0,6 MPa
Soovitatav töörõhk:	0,1 - 0,4 MPa
(1 MPa = 10 baari = 147 PSI)	
Kuuma vee temperatuur:	maks. 60°C

## Sümbolite kirjeldus

- Dušivanni kese
- Soe vesi
- Külm vesi
- Ärge kasutage äädikhapet sisaldavat silikooni!
- Selles alas tuleb seina tugevdada.
- peiteklapp
- Quattro-liitmik
- Quattro**
- Katkestus- ja ümberlülitusklapp Trio Universal
- Trio**
- Mittevajalik väljavool tuleb sulgeda korgiga.
- Äravoolu jõudlus peab olema suurem kui 50 l/min.
- > 50 l/min**
- Äravool
- Raindrain**
- Mõõtude** (vt lk 31)
- Läbivooludiagramm** (vt lk 33)
- Varuosad** (vt lk 36)
- Puhastamine** (vt lk 37 - 38) ja kaasasolev brošüür
- Kontrollsertifikaat** (vt lk 39)





## Drošības norādes

- Montāžas laikā, lai izvairītos no saspiedumiem un iegriezumiem, nepieciešams nēsāt cimdus.
- Šo dušas sistēmu drīkst izmantot tikai, lai mazgātos, higiēnai un ķermeņa tīrīšanai.
- Bērni, kā arī pieaugušie ar fiziskiem, garīgiem un / vai sensoriskiem ierobežojumiem nedrīkst lietot šo dušas sistēmu bez uzraudzības. Personas, kas atrodas alkohola vai narkotisko vielu iespaidā, nedrīkst lietot šo dušas sistēmu.
- Nepieciešams izvairīties no dušas strūkļas tieša kontakta ar jutīgām ķermeņa daļām (piem., acīm). Nepieciešams ievērot pietiekošu attālumu starp dušu un ķermeni.
- Galvas dušas statīvs paredzēts vienīgi galvas dušas atbalsīšanai, to nedrīkst noslogot ar citiem priekšmetiem!

## Norādījumi montāžai

- Pirms montāžas nepieciešams pārbaudīt, vai produktam transportēšanas laikā nav radušies bojājumi. Pēc iebūvēšanas bojājumi, kas radušies transportēšanas laikā, vai virsmas bojājumi netiek atzīti.
- Caurulvadi un armatūra ir jāuzstāda, jāizskalo un jāpārbauda saskaņā ar spēkā esošajiem standartiem.
- Jāievēro attiecīgās valstīs spēkā esošās montāžas prasības.
- Ja izstrādājuma montāžu veic kvalificēti speciālisti, jāseko, lai nostiprināšanas virsma visā nostiprināšanas zonā būtu gluda (šuves un flīzes nav izvirzītas uz āru), lai sienas konstrukcija būtu piemērota izstrādājuma montāžai un būtu pietiekami izturīga
- Šo izstrādājumu nevar uzstādīt kopā ar hidrauliski un termiski vadītu caurplūdes sildītāju.

## Tehniskie dati

Darba spiediens:

leteicamais darba spiediens:  
(1 MPa = 10 bar = 147 PSI)

Karstā ūdens temperatūra:

maks. 0,6 MPa

0,1 – 0,4 MPa

maks. 60°C

## Simbolu nozīme



Dušas paliktņa vidus



Siltais ūdens



Aukstais ūdens



Neizmantot silikonu, kas satur etiķskābi!



Šajā zonā ir nepieciešams pastiprināt sienu.



Zemapmetuma ventilis



Četrvirzienu pārslēgs

**Quattro**



Trīsvirzienu universālais noslēgvārsts un pārslēdzējvārsts

**Trio**



Neizmantoto izteku aizbāzt ar aizbāzni.



> 50 l/min

Noteces veikspējai jābūt vairāk nekā 50 l/min.



**Raindrain**

Notece

**Izmērus** (skat. 31. lpp.)



**Caurplūdes diagramma**  
(skat. 33. lpp.)



**Rezerves daļas** (skat. 36. lpp.)



**Tīrīšana** (skat. 37 - 38. lpp.) un klāt pievienotais buklets



**Pārbaudes zīme** (skat. 39. lpp.)



**Montāža skat. 31. lpp.**



## Sigurnosne napomene

- ⚠ Prilikom montaže se radi sprečavanja prignječenja i posekotina moraju nositi rukavice.
- ⚠ Sistem tuša sme da se koristi samo za kupanje, tuširanje i ličnu higijenu.
- ⚠ Deca, kao i telesno, mentalno i/ili senzorno hendikepirane odrasle osobe ne smeju da koriste sistem tuša bez nadzora. Osobe koje su pod uticajem alkohola ili droga ne smeju da koriste sistem tuša.
- ⚠ Mora se izbegavati kontakt mlaza iz tuša sa osetljivim delovima tela (npr. očima). Telo korisnika mora biti na dovoljnom odstojanju od tuša.
- ⚠ Nosač tuša iznad glave je dimenzioniran samo za držanje datog tuša i ne sme se opterećivati drugim predmetima!

















## Instrukcije za montažu

- Pre montaže se mora proveriti da li je proizvod oštećen pri transportu. Nakon ugradnje se ne priznaju nikakve reklamacije koje se odnose na površinska i transportna oštećenja.
- Vodovi i armatura moraju biti postavljeni, isprani i testirani prema važećim normama.
- Treba se pridržavati propisa koji u određenim zemljama važe za instalacije.
- Kada proizvod montira kvalifikovano stručno osoblje treba paziti da čitava površina na koju se učvršćuje bude ravna (bez istaknutih fuga ili krivljenja pločica), da je zidna konstrukcija primerena montaži proizvoda, i posebno da nema slabih mesta. Prilože
- Ovaj proizvod se ne može koristiti uz hidraulički i termički regulisane protočne bojlere.

## Tehnički podaci

Radni pritisak:	maks. 0,6 MPa
Preporučeni radni pritisak: (1 MPa = 10 bar = 147 PSI)	0,1 - 0,4 MPa
Temperatura vruće vode:	maks. 60°C

## Opis simbola

-  Sredina tuš-kada
-  topla voda
-  hladna voda
-  Nemojte koristiti silikon koji sadrži sirćetnu kiselinu!
-  U ovoj oblasti je potrebno ojačanje zida.
-  Uzidni ventil
-  Quattro četverostruki preusmerivač
- Quattro**  
 Trio Universal ventil za zatvaranje i preklonpi ventil
- Trio**  
 Izlaz koji se ne koristi, mora se zatvoriti slepim čepom.
-  Kapacitet odvoda mora biti veći od 50 l/min.
- > 50 l/min**  
 Ispust  
**Raindrain**
- 
-  **Dijagram protoka**  
(vidi stranu 33)
-  **Rezervni delovi** (vidi stranu 36)
-  **Čišćenje** (vidi stranu 37 - 38) i priložena brošura
-  **Ispitni znak** (vidi stranu 39)





## Sikkerhetshenvisninger

- △ Bruk hansker under montasjen for å unngå klem- og kuttskader.
- △ Dusjsystemet skal kun brukes for bade-, hygiene- og kroppsurengjøringsformål.
- △ Barn og voksne med fysiske og psykiske og/eller sensoriske handicap skal ikke bruke dusjsystemet uten oppsyn. Personer som er påvirket av alkohol eller narkotika skal ikke bruke dusjsystemet.
- △ Dusjstrålen skal ikke komme i kontakt med ømfintlige kroppsdeler (f.eks. øynene). Overhold en tilstrekkelig avstand mellom dusjen og kroppen.
- △ Armen til hodedusjen er kun laget for å holde hodedusjen. Den må ikke belastes med andre gjenstander!

## Montagehenvisninger

- Før montasjen skal produktet sjekkes for transportskader. Etter monteringen aksepteres ikke noen transport- eller overflateskader.
- Ledningene og armaturen skal monteres, spyles og sjekkes iht. de gyldige normer.
- Gjeldende retningslinjer for rørleggerarbeid i de enkelte land skal følges.
- Når kvalifisert fagfolk monterer produktet, skal man påse at hele området der produktet monteres er plant (ingen fremstående fuger eller flisekanter), at oppbygging av veggen er egnet for montasje av produktet og at veggen ikke viser noen svakpunkter. Med
- Dette produktet kan ikke brukes i forbindelse med hydraulisk og termisk styrte gjennomstrømningsovner.

## Tekniske data

Driftstrykk	maks. 0,6 MPa
Anbefalt driftstrykk: (1 MPa = 10 bar = 147 PSI)	0,1 - 0,4 MPa
Varmtvannstemperatur	maks. 60°C

## Symbolbeskrivelse

-  Midten på dusjkar
-  Varmtvann
-  Kaldtvann
-  Ikke bruk silikon som inneholder eddiksyre!
-  I dette området skal veggen forsterkes.
-  Innfelt ventil
-  Quattro fire-veis omstilling
- Quattro**
-  Trio universal stenge- og omstillingsventil
- Trio**
-  Utgangen som ikke brukes kan tettes med en blindplugg.
-  Avløp ytelse skal være mer enn 50 l/min.
- > 50 l/min**
-  Avløp
- Raindrain**
- Mål** (se side 31)
-  **Gjennomstrømningsdiagram** (se side 33)
-  **Service deler** (se side 36)
-  **Rengjøring** (se side 37 - 38) og vedlagt brosjyre
-  **Prøvermerke** (se side 39)



**Montasje se side 31**



## **Указания за безопасност**

- ⚠ При монтажа трябва да се носят ръкавици, за да се избегнат наранявания поради притискане или порязване.
- ⚠ Позволено е използването на системата на душа само за къпане, хигиена и цели на почистване на тялото.
- ⚠ Не е позволено деца, както и възрастни с физически, умствени и / или сензорни ограничения да използват системата на душа без надзор. Не е позволено използването на системата на душа от лица, употребили алкохол или дрога.
- ⚠ Трябва да се избягва контакта на струите на разпръсквателя с чувствителни части на тялото (напр. очите). Между разпръсквателя и тялото трябва да се спазва достатъчно разстояние.
- ⚠ Рамото на разпръсквателя за главата е разработена само, за да държи разпръсквателя за главата, то не бива да се натоварва с други предмети!

## **Указания за монтаж**

- Преди монтажа продуктът трябва да се провери за транспортни щети. След монтажа не се признават транспортни или повърхностни щети.
- Тръбопроводите и арматурата трябва да се монтират, промият и проверят в съответствие с валидните норми.
- Трябва да бъдат спазвани валидните в съответните страни предписания за инсталиране.
- При монтаж на продукта от квалифицирани специалисти да се внимава за това, закрепващата повърхност в целия диапазон на закрепването да бъде равна (без изпъкнали fugи или изместване на плочки), конструкцията на стената да е подходяща за монтаж на продукта
- Този продукт не може да се използва във връзка с хидравлично и термично управляеми проточни нагреватели.

## **Технически данни**

Работно налягане: макс. 0,6 МПа  
 Препоръчително работно налягане: 0,1 – 0,4 МПа  
 (1 МПа = 10 bar = 147 PSI)  
 Температура на горещата вода: макс. 60°C

## **Описание на символите**



Среда на коритото на душ-кабината



Топла вода



Студена вода



Не използвайте силикон, съдържащ оцетна киселина!



В тази област е необходимо подсилване на стената.



Клапан за мазилка



Четирипътно превключване Quattro

**Quattro**



Спирателен и превключващ клапан Trio Universal



Излишният извод може да се уплътни с глуха пробка.



**> 50 l/min**

Мощността на изтичане трябва да бъде повече от 50 л/мин.



Отвеждане

**Размери** (вижте стр. 31)



**Диаграма на потока**  
(вижте стр. 33)



**Сервизни части** (вижте стр. 36)



**Почистване** (вижте стр. 37 - 38) и приложена брошура







**Контролен знак** (вижте стр. 39)



## **Монтаж вижте стр. 31**



## Udhëzime sigurie

-  Për të evituar lëndimet e pickimeve ose të prerjeve gjatë procesit të montimit duhet që të vishni doreza.
-  Sistemi i dushit duhet të përdoret vetëm qëllimet e banjave, të higjienës dhe të larjes së trupit.
-  Fëmijët dhe të rriturit me aftësi të kufizuara fizike, mendore dhe/ose ndijuese nuk duhet ta përdorin sistemin e dushit pa qenë nën mbikëqyrje. Personat që janë nën ndikimin e drogave ose të alkoolit nuk duhet ta përdorin sistemin e dushit.
-  Kontakti i valëve të dushit me pjesët e ndjeshme të trupit (p.sh. me sytë) duhet që të shmanget. Midis dushit dhe trupit duhet që të mbahet një distancë e mjaftueshme.
-  Mbatjesja e kokës së dushit është projektuar vetëm për mbajtjen e kokës së dushit dhe nuk duhet që të rëndohet me objekte të tjera!

## Udhëzime për montimin















- Përpara montimit duhet që produkti të kontrollohet për dëmtime nga transporti. Pas instalimit nuk do të njihet asnjë dëmtim nga transporti ose dëmtim i sipërfaqes.
- Tubacionet dhe rubinetet duhet që të montohen, të shpëlahen dhe të kontrollohen sipas standardeve në fuqi
- Duhet të respektohen linjat udhëzuese të instalimit, të vlefshme për vendet respektive.
- Gjatë montimit të produktit nga ana e personit të kualifikuar duhet pasur parasysh që e gjithë sipërfaqja mbërthyesë të jetë e drejtë (nuk duhet të ketë hapësira mes pllakave). Mbi të gjitha muri duhet të jetë i përshtatshëm për montim dhe nuk duhet të ke
- Ky produkt nuk mund të përdoren me ngrohës elektrikë të ujit të drejtuara në mënyrë hidraulike ose termike.

## Të dhëna teknike

Presioni gjatë punës  
 Presioni i rekomanduar:  
 (1 MPa = 10 bar = 147 PSI)  
 Temperatura e ujit të ngrohtë

maks. 0,6 MPa  
 0,1 – 0,4 MPa  
 maks. 60 °C

## Përshkrimi i simbolit

-  Mesi i vaskës së dushit
-  Uji i ngrohtë
-  Uji i ftohtë
-  Mos përdorni silikon që në përbërje ka acid acetik.
-  Në këtë zonë është i nevojshëm një përforsim i murit.
-  Ventili i suvajës
-  Valvul devijuese Quattro me katër drejtime
- Quattro**  
 Valvul universale Trio për bllokim dhe devijim
- Trio**  
 Dalja që nuk nevojitet duhet izoluar me tapë qorre.
-  Kapaciteti i shkarkimit duhet të jetë më shumë se 50 l/minutë.
- > 50 l/min**  
 Shkarkimi
- Përmasat** (shih faqen 31)
-  **Diagrami i qarkullimit** (shih faqen 33)
-  **Pjesë ndërrimi** (shih faqen 36)
-  **Pastrimi** (shih faqen 37 - 38) dhe broshura bashkëngjitur
-  **Shenja e kontrollit** (shih faqen 39)



## Montimi shih faqen 31



وصف الرمز

تنبيهات الأمان



يجب إرتداء قفازات لليد أثناء التركيب لتجنب حدوث أخطار الإنحشار أو الجروح.

باينو مزود بدش في المنتصف



يجب إستخدام نظام الدش فقط لأغراض الإستحمام والأغراض الصحية وأغراض تنظيف الجسم.

ماء دافئ



ممنوع إستخدام نظام الدش بدون ملاحظة من البالغين سواء في حالة إستخدامه من طرف أطفال أو البالغين يعانون من قصور جسدي أو عقلي أو عصبي يمنعهم من الإحساس بدرجات حرارة المياه. لا يسمح لأي شخص تحت تأثير تناول الكحول أو المخدرات من إستخدام نظام الدش.

ماء بارد



هام! لا تستخدم السليكون الذي يحتوي على أحماض!



يلزم هذا في النطاق وجود تقوية للحائط.



صمام التدفق



يجب تجنب حدوث إتصال مباشر بين الماء الخارج من رأس الدش وبين أجزاء الجسم الحساسة (مثل العينين). يجب وجود مسافة كافية بين رأس الدش والجسم.

وظيفة ذراع دش الرأس هي فقط الإمساك بدش الرأس، ولذلك يجب عدم التحميل عليه بأشياء أخرى.

تغيير مسار رباعي كواترو



Quattro

تعليمات التركيب

صمام حجز وتغيير تريو يونيفرسال



Trio

قبل القيام بعملية التركيب، يجب فحص المنتج للتأكد من خلوه من أية تلفيات ناتجة عن النقل. بعد القيام بعملية التركيب، لن يتم الاعتراف بوجود أية تلفيات سطحية أو تلفيات ناتجة عن عملية النقل.

قم بسد المنفذ غير المستخدم.



يجب تركيب وغسيل واختبار التوصيلات وخلطات المياه طبقاً للمعايير السارية.

يجب أن تكون قدرة الصرف أكبر من 50 لتر/دقيقة



> 50 l/min

يجب مراعاة القواعد الخاصة بالتركيب وأعمال السباكة وفقاً للوائح الخاصة بكل بلد.

تصريف



Raindrain

يجب الانتباه عند تركيب المنتج بواسطة فريق العمل المتخصص إلى أن جميع مواضع التثبيت جاهزة للتثبيت دون عوائق (خالية من المفصلات أو المصقات)، وأن الحائط جاهز لتركيب المنتج مع عدم احتوائه على أية أماكن ضعيفة. مبيبات المسامير (الفيشر) والمسامير نفسها مناسبة لل

أبعاد (راجع صفحة 31)



لا يمكن إستعمال هذا المنتج مع سخانات الماء الفورية الهيدروليكية أو الحرارية.

رسم للصراف



(راجع صفحة 33)

المواصفات الفنية

ضغط التشغيل: الحد الأقصى 0,6 ميجابسكال  
ضغط التشغيل الموصى به: 0,4 - 0,1 ميجابسكال

قطع الغيار (راجع صفحة 36)



(1 ميجابسكال = 10 بار = 147 PSI)

الحد الأقصى 60°C درجة حرارة الماء الساخن:

التنظيف



(راجع صفحة 37 - 38) والكتيب المرفق

شهادة اختبار (راجع صفحة 39)



الترايب راجع صفحة 31

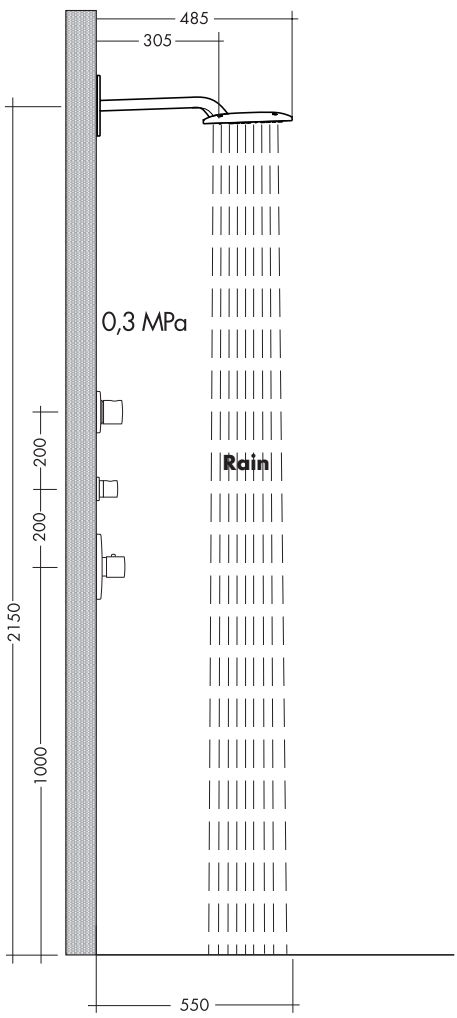
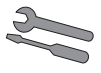
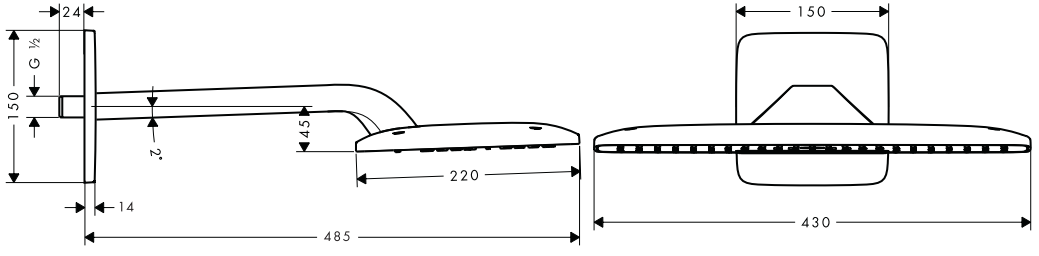
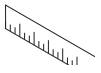

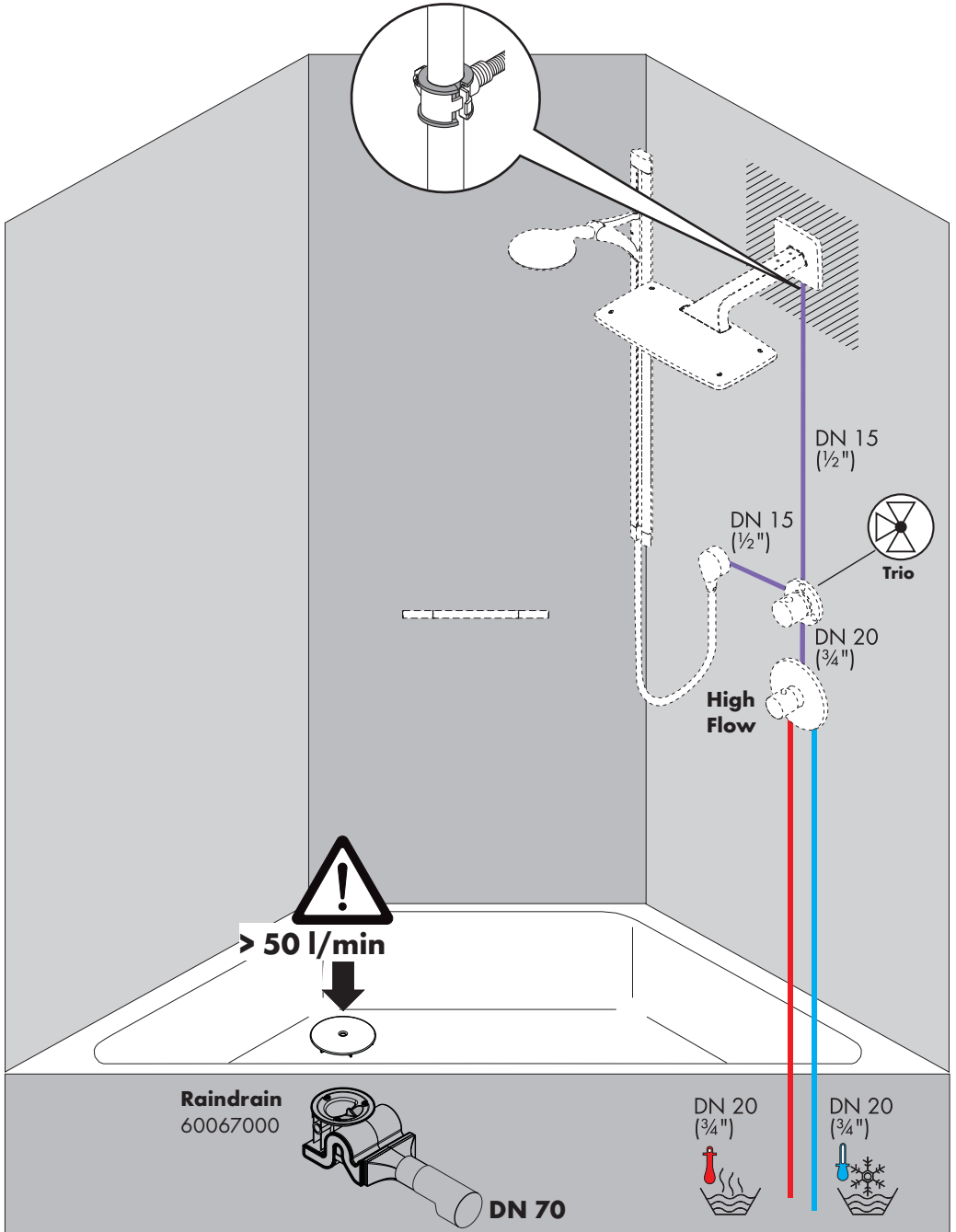





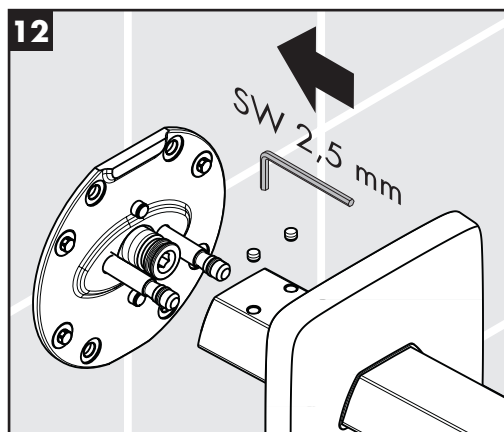
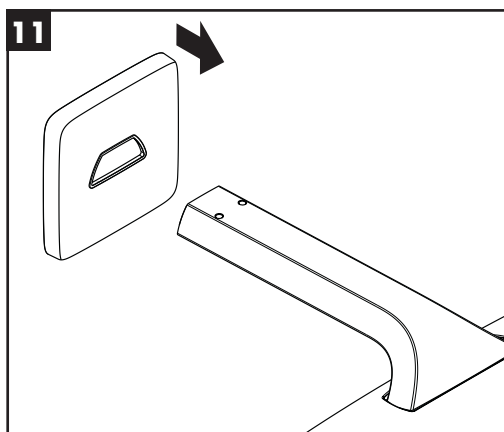
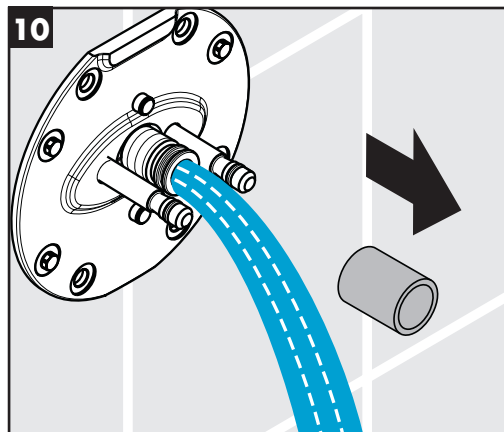
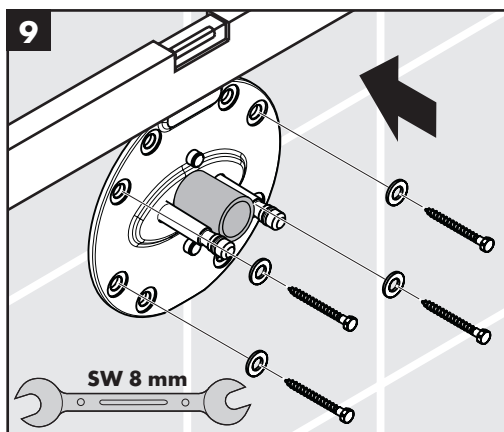
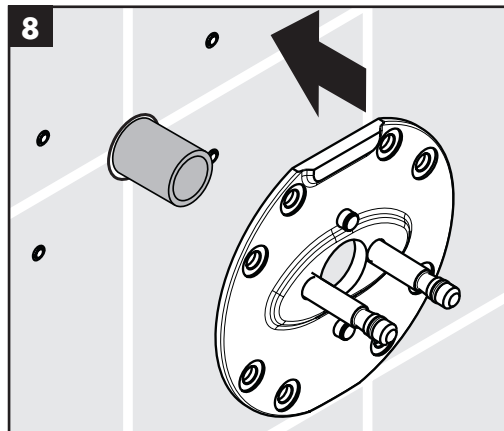
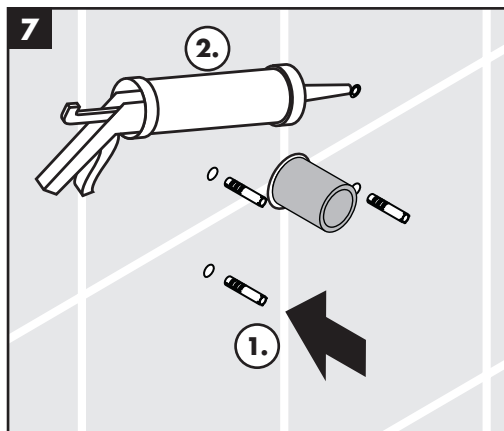

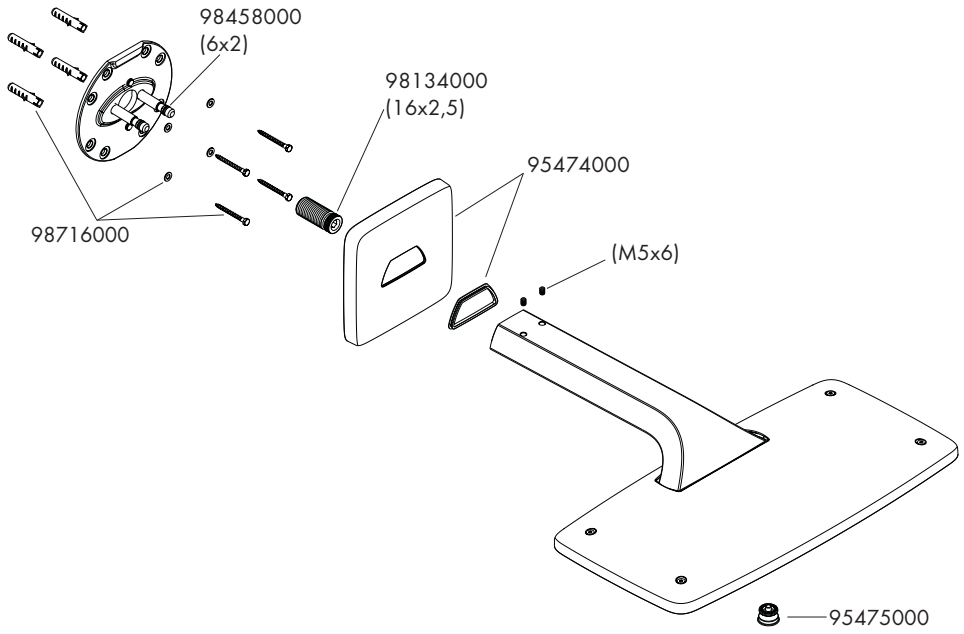

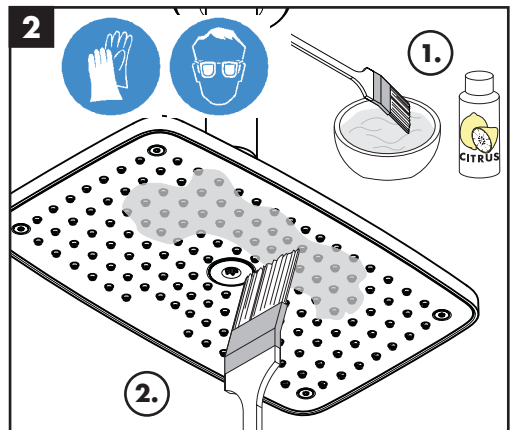
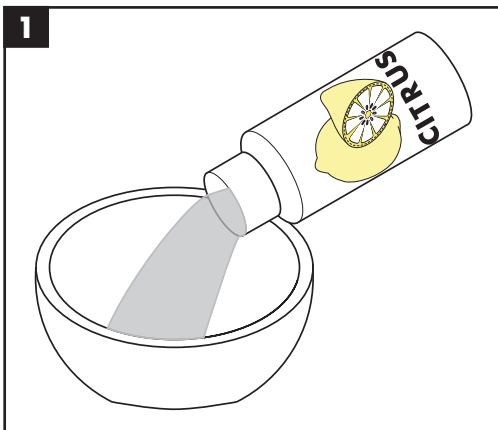
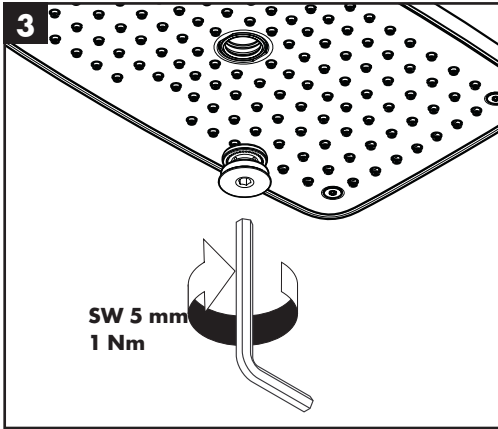
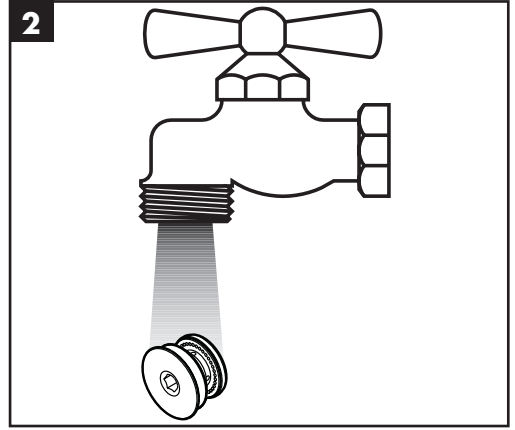
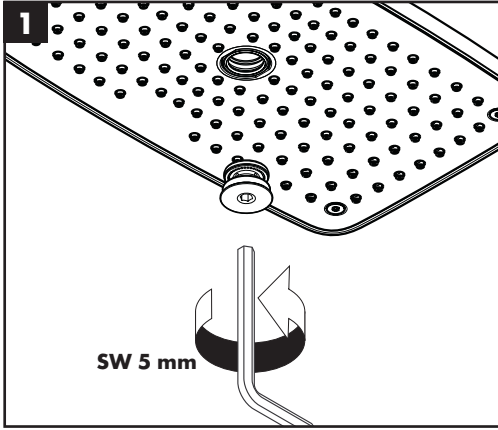

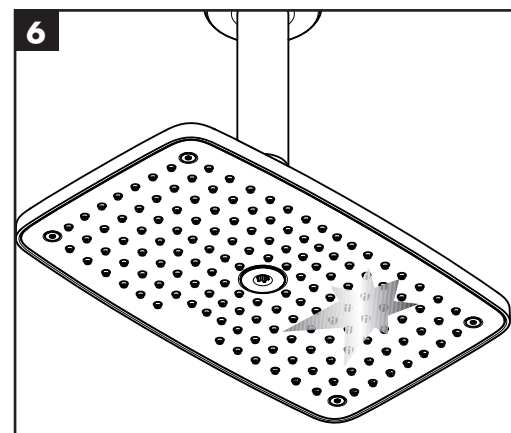
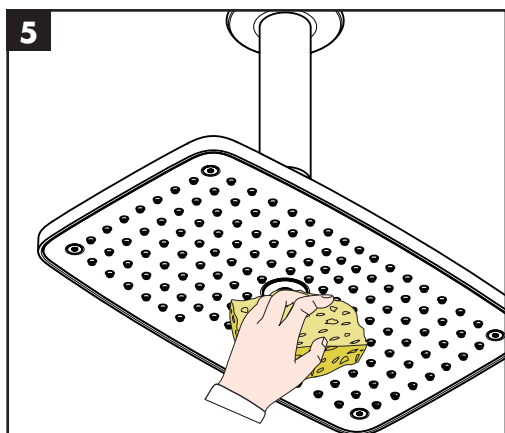
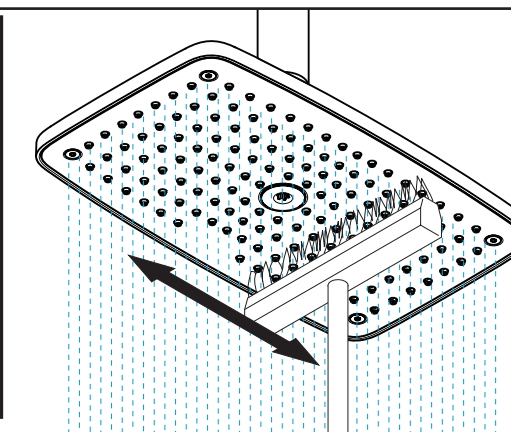
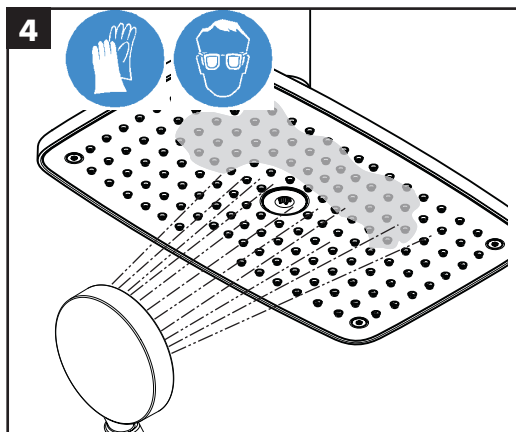
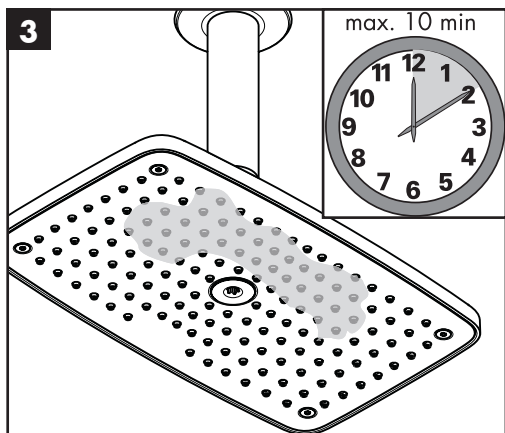



---

	<b>PA-IX</b>	<b>DVGW</b>	<b>SVGW</b>	<b>ACS</b>	<b>WRAS</b>	<b>KIWA</b>	<b>ETA</b>
<b>27372000</b>				X	X		

---

---

**hansgrohe**

Hansgrohe · AuestraÙe 5 · 9 · D-77761 Schiltach · Telefon +49 (0) 78 36/51-1282 · Telefax +49 (0) 7836/511440  
E-Mail: [info@hansgrohe.com](mailto:info@hansgrohe.com) · Internet: [www.hansgrohe.com](http://www.hansgrohe.com)

08/2014  
9,0114003