

Level Measurement

Point level measurement

Rotation paddle switches

SITRANS LPS200

Overview



SITRANS LPS200 is a rotary paddle switch for point level and material detection in bulk solids.

Benefits

- Proven paddle switch technology for bulk solids
- High integrity mechanical seal
- Universal power supply options available
- Unique friction clutch mechanism prevents damage from falling material
- Rotatable enclosure for convenient wiring
- Optional paddles for use with low density materials
- Small paddle makes for simple installation through existing process connection
- High temperature model and optional extension kit available
- Optional fail-safe configuration detects loss of rotation
- Functional Safety (SIL 2). Device suitable for use in accordance with IEC 61508 and IEC 61511

Application

The paddle switch technology detects full, empty, or demand conditions on materials such as grain, feed, cement, plastic granulate, and wood chips. The paddle switch can handle bulk densities as low as 15.06 g/l (0.94 lb/ft³) with the optional rectangular vane or 100 g/l (6.25 lb/ft³) with the standard measuring vane.

A low revolution geared motor with slip clutch drives a rotating measuring vane which senses the presence of material at the mounted level of the LPS200. As material comes into contact with the rotating paddle, rotation stops, which changes the microswitch state. When the paddle is no longer covered by material, rotation resumes and the relay reverts to its normal condition.

The LPS200 has a rugged design for use in harsh conditions in the solids industry. The sensitivity of the paddle can be adjusted for varying material properties like buildup on the vane.

The LPS200 comes in a variety of configurations including compact, extended and cable extension. It is equipped with a standard vane which is effective in most applications, but can be configured with a hinged or rectangular vane for increased sensitivity for light materials.

- Key Applications: bulk solids such as grain, feed, cement, plastic granulate, wood chips

Technical specifications

Mode of operation	
Measuring principle	Rotating point level switch
Input	
Measured variable	High and low and demand
Output	
Output signal	Microswitch 5 A at 250 V AC, non-inductive Microswitch SPDT contact 4 A at 30 V DC, non-inductive
• Alarm output	
• Pickup delay	Standard (1 rpm model): approx. 1.3 seconds Optional process applications (5 rpm model): approx. 0.26 seconds
Sensitivity	
Adjustable via reset force of spring or geometry of measuring vane	
Rated operating conditions	
Installation conditions	
• Location	Indoor/outdoor
Ambient conditions	
• Ambient temperature	-25 ... +60 °C (-13 ... +140 °F)
• Installation category	III
• Pollution degree	2
Medium conditions	
• Temperature	Bulk solids
- Standard	-25 ... +80 °C (-13 ... +176 °F)
- Optional	-25 ... +600 °C (-13 ... +1 112 °F)
Higher temperature version is available. Consult a local sales person for details. For more information, please visit http://www.automation.siemens.com/aspa_app .	
• Pressure (vessel)	
- Standard	Max. 0.5 bar g (7.25 psi g)
- Optional	Max. 10 bar g (145 psi g)
• Minimum material density	
- Standard measuring vane	Can detect down to 100 g/l (6.25 lb/ft ³)
- Optional measuring vane	Can detect down to 15.06 g/l (0.94 lb/ft ³)
Design	
Material	
• Enclosure	Epoxy coated aluminum
• Process connection, measuring shaft and vane	Stainless steel or aluminum
Process connection	Thread NPT, BSP, and flange options
Degree of protection	IP65/Type 4/NEMA 4
Conduit entry	2 x M20 x 1.5 or 2 x 1/2" NPT (For FM and CSA approved versions only.)
Power supply	
AC or DC versions	115 V AC, ± 15 %, 50 ... 60 Hz, 4 VA or 230 V AC, ± 15 %, 50 Hz, 6 VA, or 48 V AC, or 24 V AC, or 24 V DC, ± 15 %, 2.5 W
Universal voltage (DPDT replay)	24 V DC ± 15 % 50 ... 60 Hz, 22 ... 230 V AC, ± 10 %, max. 10 VA
Certificates and approvals	
<ul style="list-style-type: none"> • CSA/FM General Purpose • CE • CSA/FM Dust Ignition Proof • ATEX II 1/2 D • RCM • IECex 	

Selection and Ordering data	Article No.	Ord. code	Selection and Ordering data	Article No.	Ord. code
SITRANS LPS200, compact Rotary paddle switch for level and material detection in bulk solids. Compact design for side or top mounted applications. ↗ Click on the Article No. for the online configuration in the PIA Life Cycle Portal.	7ML5725-	0	SITRANS LPS200, compact Rotary paddle switch for level and material detection in bulk solids. Compact design for side or top mounted applications.	7ML5725-	0
Process temperature Up to 80 °C (176 °F) Up to 150 °C (302 °F) Up to 250 °C (482 °F) Up to 600 °C (1 112 °F) ¹⁾²⁾ Up to 80 °C (176 °F) basic version aluminum ¹⁾³⁾ Up to 80 °C (176 °F) basic version stainless steel ¹⁾⁴⁾	1 2 3 4 5 6		Process pressure Up to 0.5 bar (7.25 psi) Up to 5 bar (72.5 psi) Up to 10 bar (145 psi)	1 2 3	
Power supply 230 V AC, 1 rev/min. 230 V AC, 5 rev/min. 115 V AC, 1 rev/min. 115 V AC, 5 rev/min. 48 V AC, 1 rev/min. 24 V AC, 1 rev/min. 24 V DC, 1 rev/min. 24 V DC, 5 rev/min. 48 V AC, 5 rev/min. 24 V AC, 5 rev/min. Universal Voltage, 1 rev/min. Universal Voltage, 1 rev/min., fail-safe Universal Voltage, 5 rev/min. Universal Voltage, 5 rev/min. fail-safe	A C E G J K L N Z Z Z Z Z	J 1 B J 1 E J 2 A J 2 B J 2 C J 2 D	Process connection material Aluminum ⁷⁾ Stainless steel, threads 303 (1.4305), flanges 321 (1.4541), Tri-clamp 304 (1.4301) Stainless steel 316L (1.4404) ⁸⁾	1 2 3	
Process connection Threaded G 1¼" [(BSPP), EN ISO 228-1] G 1" [(BSPP), EN ISO 228-1] G 1½" [(BSPP), EN ISO 228-1] 1" NPT [(Taper), ANSI/ASME B1.20.1] 1¼" NPT [(Taper), ANSI/ASME B1.20.1] 1½" NPT [(Taper), ANSI/ASME B1.20.1]	A B C D E F		Extension length 100 mm (3.94 inch) ⁹⁾ 150 mm (5.91 inch) 200 mm (7.87 inch) 250 mm (9.84 inch) 300 mm (11.81 inch)	1 2 3 4 5	
Flanged DN 32 PN 6, EN 1092-1, flat face ⁵⁾ DN 100 PN 6, EN 1092-1, flat face ⁵⁾ DN 100 PN 16, EN 1092-1, flat face 2" ASME 150 lb B16.5, raised face 3" ASME 150 lb B16.5, raised face 4" ASME 150 lb B16.5, raised face 2" Tri-clamp (DN 50) ISO 2852 ⁶⁾	G H J K L M N		Measuring vane Boot shaped, 35 x 106 mm (1.38 x 4.17 inch) ¹⁰⁾ Hinged vane, 65 x 200 mm (2.56 x 7.87 inch) ¹⁰⁾¹¹⁾ Boot shaped, 28 x 98 mm (1.10 x 3.86 inch) Rectangular, 50 x 150 mm (1.97 x 5.91 inch) ¹²⁾ Rectangular, 50 x 250 mm (1.97 x 9.84 inch) ¹²⁾ Rectangular, 98 x 150 mm (3.86 x 5.91 inch) ¹¹⁾¹²⁾ Rectangular, 98 x 250 mm (3.86 x 9.84 inch) ¹¹⁾¹²⁾ Rectangular, 50 x 98 mm (1.97 x 3.86 inch) ¹²⁾	A B C D E F G H	
			Approvals CSA/FM Dust Ignition Proof, RCM ATEX II 1/2 D, RCM CSA/FM General Purpose, RCM, CE CE, RCM IEC Ex ta/tb IIIC EAC Ex ta/tb IIIC Da/Db	A B C D E F	

Level Measurement

Point level measurement

Rotation paddle switches

SITRANS LPS200

Selection and Ordering data

Order code

Further Designs

Please add **"-Z"** to Article No. and specify Order code(s).

Heating of enclosure¹³⁾¹⁴⁾

A35

Signal bulb inserted in M20 cable gland¹³⁾

A20

Food grade materials (in contact with process), according to 1935/2004/EC, with FDA conform shaft sealing¹⁵⁾

K01

Stainless steel tag [100 x 45 mm (3.94 x 1.77 inch)]: Measuring-point number/identification (max. 27 characters); specify in plain text

Y14

Functional Safety (SIL 2). Device suitable for use in accordance with IEC 61508 and IEC 61511.¹⁷⁾¹⁸⁾

C20

Operating Instructions

Article No.

Multi-language

A5E34210883

Note: The Operating Instructions should be ordered as a separate line on the order.

All literature is available to download for free, in a range of languages, at <http://www.siemens.com/processinstrumentation/documentation>

Spare Parts

Replacement vane, boot shape, 35 x 106 mm (1.38 x 4.17 inch)

7ML1830-1KH

Hinged vane, 98 x 200 mm (3.86 x 7.87 inch)

7ML1830-1KJ

Rigid extension kit

(Includes spring coupling, rigid tube extension, and required pins)

Extension: 500, 400, 300 mm (19.7, 15.8, 11.8 inch)¹⁶⁾

7ML5711-0AA

Extension: 1 000, 900, 800, 700, 600 mm (39.4, 35.4, 31.5, 27.6, 23.6 inch)¹⁶⁾

7ML5711-1AA

Extension: 1 500, 1 400, 1 300, 1 200, 1 100 mm (59.1, 55.1, 51.2, 47.2, 43.3 inch)¹⁶⁾

7ML5711-2AA

Rope extension kit, 2 m (6.56 ft)

7ML1830-1KK

Selection and Ordering data

Article No.

SITRANS LPS200, compact for up to 80 °C (176 °F), aluminum, with power supply E, process connection E, process pressure 1, process connection material 1, extension length 2, measuring vane A, and approval C

7ML5725-5EE11-2AC0

SITRANS LPS200, compact for up to 80 °C (176 °F), stainless steel, with power supply Z (J2A), process connection C, process pressure 1, process connection material 2, extension length 2, measuring vane A, and approval B

7ML5725-6ZC12-2AB0 J2A

SITRANS LPS200, compact for up to 80 °C (176 °F), stainless steel, with power supply Z (J2A), process connection E, process pressure 1, process connection material 2, extension length 2, measuring vane A, and approval A

7ML5725-6ZE12-2AA0 J2A

- 1) Available with approval options C and D only, up to 0.5 bar.
- 2) Not available with process connections A, B, D, E, and G.
- 3) Only available with the following configurations 7ML5725-5AC11-2AD0 or 7ML5725-5EE11-2AC0.
- 4) Only available with the following configurations 7ML5725-6ZC12-2AB0 J2A or 7ML5725-6ZE12-2AA0 J2A.
- 5) Available with process pressure options 1 and 2 only.
- 6) Available with process temperature option 1 only.
- 7) Available with process connection options A ... F only, process pressure option 1 and process temperature options 1 and 5 only.
- 8) Available with process connection options C, F, H ... N and Measuring vane options A and B.
- 9) Available with measuring vane options A, C, D, E, H only.
- 10) Add 16 mm (0.63 inch) to extension length.
- 11) Available with extension lengths 2, 3, 4, 5.
- 12) Available with process connection options H ... M only.
- 13) Available with approval option D only.
- 14) Available with power supply options A, C, E, G, J, K, L, N, J1B, J1D, J1E, J2A, J2C only.
- 15) Available up to 250 °C (482 °F). This option does not automatically implement a food conform design.
- 16) Pendulum shaft 500 mm/1 000 mm/1 500 mm should be selected with 150 mm standard length 2 and vane A (35 x 106) to get to the desired lengths.
- 17) Available with Power supply options J2A and J2C only.
- 18) Available with Approval options A, B, C, D, and E only. Approvals A and C with FM only.

Selection and Ordering data	Article No.	Ord. code	Selection and Ordering data	Article No.	Ord. code
SITRANS LPS200, shaft protected Rotary paddle switch for level and material detection in bulk solids; ideal for heavy, sticky, or high impact applications. Designed with added protection tube for enhanced shaft protection and protection against buildup on shaft (sidewall buildup). ↗ Click on the Article No. for the online configuration in the PIA Life Cycle Portal.	7ML5726-		SITRANS LPS200, shaft protected Rotary paddle switch for level and material detection in bulk solids; ideal for heavy, sticky, or high impact applications. Designed with added protection tube for enhanced shaft protection and protection against buildup on shaft (sidewall buildup).	7ML5726-	
Process temperature Up to 80 °C (176 °F) Up to 150 °C (302 °F) Up to 250 °C (482 °F) Up to 600 °C (1 112 °F) ¹⁾²⁾ Up to 80 °C (176 °F) basic version ³⁾	1 2 3 4 5		Process pressure Up to 0.5 bar (7.25 psi) Up to 5 bar (72.5 psi) Up to 10 bar (145 psi)	1 2 3	
Power supply 230 V AC, 1 rev/min. 230 V AC, 5 rev/min. 115 V AC, 1 rev/min. 115 V AC, 5 rev/min. 48 V AC, 1 rev/min. 24 V AC, 1 rev/min. 24 V DC, 1 rev/min. 24 V DC, 5 rev/min. 48 V AC, 5 rev/min. 24 V AC, 5 rev/min. Universal Voltage, 1 rev/min. Universal Voltage, 1 rev/min., fail-safe Universal Voltage, 5 rev/min. Universal Voltage, 5 rev/min., fail-safe	A C E G J K L N Z Z Z Z Z	J 1 B J 1 E J 2 A J 2 B J 2 C J 2 D	Process connection material Aluminum ⁶⁾ Stainless steel, threads 303 (1.4305), flanges 321 (1.4541), Tri-clamp 304 (1.4301) ¹⁸⁾ Stainless steel 316L (1.4404) ⁷⁾	1 2 3	
Process connection Threaded G 1¼" [(BSPP), EN ISO 228-1] G 1½" [(BSPP), EN ISO 228-1] 1¼" NPT [(Taper), ANSI/ASME B1.20.1] 1½" NPT [(Taper), ANSI/ASME B1.20.1] Flanged DN 32 PN 6, EN 1092-1, flat face ⁴⁾ DN 100 PN 6, EN 1092-1, flat face ⁴⁾ DN 100 PN 16, EN 1092-1, flat face 2" ASME 150 lb B16.5, raised face 3" ASME 150 lb B16.5, raised face 4" ASME 150 lb B16.5, raised face 2" Tri-clamp (DN 50) ISO 2852 ⁵⁾	A B C D E F G H J K L		Extension length 150 mm (5.91 inch) ⁸⁾ 200 mm (7.87 inch) 250 mm (9.84 inch) 300 mm (11.81 inch)	1 2 3 4	
			Extension material (protection tube) Aluminum ⁹⁾ Stainless steel 303 (1.4305) Stainless steel 316L (1.4404) ¹⁰⁾	A B C	
			Measuring vane Boot shaped, 35 x 106 mm (1.38 x 4.17 inch) ¹¹⁾ Hinged vane, 65 x 200 mm (2.56 x 7.87 inch) ¹⁾¹²⁾ Rectangular, 50 x 150 mm (1.97 x 5.91 inch) ¹³⁾ Rectangular, 50 x 250 mm (1.97 x 9.84 inch) ¹³⁾ Rectangular, 98 x 150 mm (3.86 x 5.91 inch) ¹²⁾¹³⁾ Rectangular, 98 x 250 mm (3.86 x 9.84 inch) ¹²⁾¹³⁾ Rectangular, 50 x 98 mm (1.97 x 3.86 inch) ¹³⁾	A B D E F G H	
			Approvals CSA/FM Dust Ignition Proof, RCM ATEX II 1/2 D, RCM CSA/FM General Purpose, RCM, CE CE, RCM IEC Ex ta/tb IIIC EAC Ex ta/tb IIIC Da/Db	1 2 3 4 5 6	

Level Measurement

Point level measurement

Rotation paddle switches

SITRANS LPS200

Selection and Ordering data

Order code

Further Designs

Please add **"-Z"** to Article No. and specify Order code(s).

Heating of enclosure¹⁴⁾¹⁵⁾

A35

Signal bulb inserted in M20 cable gland¹⁴⁾

A20

Food grade materials (in contact with process), according to 1935/2004/EC, with FDA conform shaft sealing¹⁶⁾

K01

Stainless steel tag [100 x 45 mm (3.94 x 1.77 inch)]: Measuring-point number/identification (max. 27 characters); specify in plain text

Y14

Functional Safety (SIL 2). Device suitable for use in accordance with IEC 61508 and IEC 61511.¹⁷⁾¹⁹⁾

C20

Operating Instructions

Article No.

Multi-language

A5E34210883

Note: The Operating Instructions should be ordered as a separate line on the order.

All literature is available to download for free, in a range of languages, at <http://www.siemens.com/processinstrumentation/documentation>

Spare Parts

Replacement vane, boot shape, 35 x 106 mm (1.38 x 4.17 inch)

7ML1830-1KH

Hinged vane, 98 x 200 mm (3.86 x 7.87 inch)

7ML1830-1KJ

SITRANS LPS200, extended for up to 80 °C (176 °F), power supply Z (J2A), process connection B, process pressure 1, process connection material 2, extension length 2, extension material B, measuring vane A, and approval 2

7ML5726-5ZB12-2BA2 J2A

SITRANS LPS200, extended for up to 80 °C (176 °F), power supply Z (J2A), process connection C, process pressure 1, process connection material 2, extension length 2, extension material B, measuring vane A, and approval 1

7ML5726-5ZC12-2BA1 J2A

- 1) Available with approval options 3 and 4 only and up to max 0.5 bar.
- 2) Not available with process connection options A, C, E.
- 3) Only available with the following configurations 7ML5726-5ZB12-2BA2 J2A or 7ML5726-5ZC12-2BA1 J2A.
- 4) Available with process pressure options 1 and 2 only.
- 5) Available with process temperature option 1 only.
- 6) Available with process connection options A ... E only, available with process pressure option 1 only, and process temperature option 1 only.
- 7) Extension and vane will also change to 316L, only for process connection options B, D, F ... L and vane A.
- 8) Available with measuring vane options A, D, E, H only.
- 9) Available with process pressure option 1 and process temperature option 1 only.
- 10) Available with process connection options B, D, F ... L and vane A.
- 11) Add 16 mm (0.63 inch) to extension length.
- 12) Available with extension length options 2 ... 4 only.
- 13) Available with process connection options F, G, H, J, K only.
- 14) Available with approval option 4 only.
- 15) Available with power supply options A,C, E, G, J, K, L, N, J1B, J1D, J1E, J2A, J2C only.
- 16) Available up to 250 °C (482 °F). This option does not automatically implement a food conform design.
- 17) Available with Power supply options J2A and J2C only.
- 18) Available with Extension material Stainless steel, threads 303 option B only.
- 19) Available with Approval options 1, 2, 3, 4, and 5 only. Approvals 1 and 3 with FM only.

Selection and Ordering data	Article No.	Ord. code	Selection and Ordering data	Article No.	Ord. code
SITRANS LPS200, cable extension Rotary paddle switch for level and material detection in bulk solids. Cable extension for increased length in top-mounted applications ↗ Click on the Article No. for the online configuration in the PIA Life Cycle Portal.	7ML5727-	0	SITRANS LPS200, cable extension Rotary paddle switch for level and material detection in bulk solids. Cable extension for increased length in top-mounted applications	7ML5727-	0
Process temperature Up to 80 °C (176 °F) Up to 150 °C (302 °F) Up to 250 °C (482 °F) Up to 600 °C (1 112 °F) ¹⁾²⁾ Up to 80 °C (176 °F) basic version ³⁾	1 2 3 4 5		Process pressure Up to 0.5 bar (7.25 psi) Up to 5 bar (72.5 psi) Up to 10 bar (145 psi)	1 2 3	
Power supply 230 V AC, 1 rev/min. 230 V AC, 5 rev/min. 115 V AC, 1 rev/min. 115 V AC, 5 rev/min. 48 V AC, 1 rev/min. 24 V AC, 1 rev/min. 24 V DC, 1 rev/min. 24 V DC, 5 rev/min. 48 V AC, 5 rev/min. 24 V AC, 5 rev/min. Universal Voltage, 1 rev/min. Universal Voltage, 1 rev/min., fail-safe Universal Voltage, 5 rev/min. Universal Voltage, 5 rev/min., fail-safe	A C E G J K L N Z Z Z Z Z	J 1 B J 1 E J 2 A J 2 B J 2 C J 2 D	Process connection material Aluminum ⁵⁾ Stainless steel, threads 303 (1.4305), flanges 321 (1.4541)	1 2	
Process connection Threaded G 1¼" [(BSPP), EN ISO 228-1] G 1½" [(BSPP), EN ISO 228-1] 1¼" NPT [(Taper), ANSI/ASME B1.20.1] 1½" NPT [(Taper), ANSI/ASME B1.20.1] Flanged DN 32 PN 6, EN 1092-1, flat face ⁴⁾ DN 100 PN 6, EN 1092-1, flat face ⁴⁾ DN 100 PN 16, EN 1092-1, flat face 2" ASME 150 lb B16.5, raised face 3" ASME 150 lb B16.5, raised face 4" ASME 150 lb B16.5, raised face	A B C D E F G H J K		Cable extension length Standard cable length, 2 000 mm (78.74 inch) Add Order code Y01 and plain text: "Insertion length ... mm" 500 ... 1 000 mm (19.69 ... 39.37 inch) Cable length 1 001 ... 2 000 mm (39.41 ... 78.74 inch) Cable length 2 001 ... 3 000 mm (78.78 ... 118.11 inch) Cable length 3 001 ... 4 000 mm (118.15 ... 157.48 inch) Cable length 4 001 ... 5 000 mm (157.52 ... 196.85 inch) Cable length 5 001 ... 6 000 mm (196.89 ... 236.22 inch) Cable length 6 001 ... 7 000 mm (236.26 ... 275.59 inch) Cable length 7 001 ... 10 000 mm (275.63 ... 393.70 inch) Without extension ¹²⁾	0 1 2 3 4 5 6 7 8 9	N 1 A
			Measuring vane Boot shaped, 35 x 106 mm (1.38 x 4.17 inch) ⁶⁾ Hinged vane, 65 x 200 mm (2.56 x 7.87 inch) ⁶⁾ Boot shaped, 28 x 98 mm (1.10 x 3.86 inch) ⁷⁾ Rectangular, 50 x 150 mm (1.97 x 5.91 inch) ⁷⁾ Rectangular, 50 x 250 mm (1.97 x 9.84 inch) ⁷⁾ Rectangular, 98 x 150 mm (3.86 x 5.91 inch) ⁷⁾ Rectangular, 50 x 98 mm (1.97 x 3.86 inch) ⁷⁾	A B C D E F G	
			Approvals CSA/FM Dust Ignition Proof, RCM ATEX II 1/2 D, RCM CSA/FM General Purpose, RCM, CE CE, RCM IEC Ex ta/tb IIIC EAC Ex ta/tb IIIC Da/Db	A B C D E F	

Level Measurement

Point level measurement

Rotation paddle switches

SITRANS LPS200

Selection and Ordering data	Order code
Further Designs	
Please add *-Z* to Article No. and specify Order code(s).	
Total insertion length: Enter the total insertion length in plain text description, max. 10 000 mm (393.70 inch)	Y01
Stainless steel tag [100 x 45 mm (3.94 x 1.77 inch)]: Measuring-point number/identification (max. 27 characters); specify in plain text	Y14
Reinforced cable (max. 28 kN pulling force) ⁸⁾	P01
Heating of enclosure ⁹⁾¹⁰⁾	A35
Signal bulb inserted in M20 cable gland ⁹⁾	A20
Food grade materials (in contact with process), according to 1935/2004/EC, with FDA conform shaft sealing ¹¹⁾	K01
Functional Safety (SIL 2). Device suitable for use in accordance with IEC 61508 and IEC 61511. ¹³⁾¹⁴⁾	C20
Operating Instructions	
Multi-language	Article No. A5E34210883
Note: The Operating Instructions should be ordered as a separate line on the order. All literature is available to download for free, in a range of languages, at http://www.siemens.com/processinstrumentation/documentation	
Spare Parts	
Replacement vane, boot shape, 35 x 106 mm (1.38 x 4.17 inch)	7ML1830-1KH
Hinged vane, 98 x 200 mm (3.86 x 7.87 inch)	7ML1830-1KJ
SITRANS LPS200, cable extension for up to 80 °C (176 °F), power supply Z (J2A), process connection B, process pressure 1, process connection material 2, extension length 0, measuring vane A, and approval B	7ML5727-5ZB12-0AB0 J2A
SITRANS LPS200, cable extension for up to 80 °C (176 °F), power supply Z (J2A), process connection C, process pressure 1, process connection material 2, extension length 0, measuring vane A, and approval A	7ML5727-5ZC12-0AA0 J2A

- 1) Available with approval options C and D up to max. 0.5 bar
- 2) Not available with process connections A, C, E
- 3) Only available with the following configurations 7ML5727-5ZC12-0AA0 J2A or 7ML5727-5ZB12-0AB0 J2A
- 4) Available with process pressure options 1 and 2 only
- 5) Available with process connections A ... E only, process pressure option 1 only and process temperature options 1 and 5 only
- 6) Add 16 mm (0.63 inch) to extension length
- 7) Available with process connections F ... K only
- 8) Available only for process temperature up to 80 °C (176 °F) and process connection material 2
- 9) Available with approval option D
- 10) Available with power supply options A, C, E, G, J, K, L, N, J1B, J1D, J1E, J2A, J2C only
- 11) Available up to 250 °C (482 °F). This option does not automatically implement a food conform design (food conform gaps and radius)
- 12) Not available with P01 and available with Approval D, mounting kit for rope extension included
- 13) Available with Power supply options J2A and J2C only
- 14) Available with Approval options A, B, C, D, and E only. Approvals A and C with FM only.

Selection and Ordering data	Article No.	Ord. code	Selection and Ordering data	Order code
SITRANS LPS200, angled extension Rotary paddle switch with robust design for level and material detection in bulk solids; ideal for heavy or sticky applications. Angled extension is designed to avoid falling material and rotates horizontally in side mount applications to continue working even with heavy buildup. ↗ Click on the Article No. for the online configuration in the PIA Life Cycle Portal.	7ML5728-	0	Further Designs Please add "-Z" to Article No. and specify Order code(s). Heating of enclosure ²⁾³⁾ Signal bulb inserted in M20 cable gland ²⁾ Food grade materials (in contact with process), according to 1935/2004/EC, with FDA conform shaft sealing ⁴⁾ Stainless steel tag [100 x 45 mm (3.94 x 1.77 inch)]: Measuring-point number/identification (max. 27 characters); specify in plain text Functional Safety (SIL 2). Device suitable for use in accordance with IEC 61508 and IEC 61511. ⁵⁾⁶⁾	
Process temperature Up to 80 °C (176 °F) Up to 150 °C (302 °F) Up to 250 °C (482 °F)	1 2 3		Operating Instructions Multi-language Note: The Operating Instructions should be ordered as a separate line on the order. All literature is available to download for free, in a range of languages, at http://www.siemens.com/processinstrumentation/documentation	A35 A20 K01 Y14 C20
Power supply 230 V AC, 1 rev/min. 230 V AC, 5 rev/min. 115 V AC, 1 rev/min. 115 V AC, 5 rev/min. 48 V AC, 1 rev/min. 24 V AC, 1 rev/min. 24 V DC, 1 rev/min. 24 V DC, 5 rev/min. 48 V AC, 5 rev/min. 24 V AC, 5 rev/min. Universal Voltage, 1 rev/min. Universal Voltage, 1 rev/min., fail-safe Universal Voltage, 5 rev/min. Universal Voltage, 5 rev/min., fail-safe	A C E G J K L N Z Z Z Z Z Z	J 1 B J 1 E J 2 A J 2 B J 2 C J 2 D	Spare Parts Replacement vane, boot shape, 35 x 106 mm (1.38 x 4.17 inch) Hinged vane, 98 x 200 mm (3.86 x 7.87 inch)	Article No. A5E34210883 7ML1830-1KH 7ML1830-1KJ
Process connection Flanged DN 100 PN 6, EN 1092-1, flat face ¹⁾ DN 100 PN 16, EN 1092-1, flat face 4" ASME 150 lb B16.5, raised face	A B C		<ol style="list-style-type: none"> Available with process pressure options 1 and 2 only. Available with approval option D only. Available with power supply options A ,C, E, G, J, K, L, N, J1B, J1D, J1E, J2A, J2C only. This option does not automatically implement a food conform design. Available with Power supply options J2A and J2C only. Available with Approval options A, B, C, D, and E only. Approvals A and C with FM only. 	
Process pressure Up to 0.5 bar (7.25 psi) Up to 5 bar (72.5 psi) Up to 10 bar (145 psi)	1 2 3			
Process connection material Stainless steel 303/321 (1.4305/1.4541)	1			
Extension length 125 mm (4.92 inch) 150 mm (5.91 inch) 200 mm (7.87 inch) 250 mm (9.84 inch) 300 mm (11.81 inch)	1 2 3 4 5			
Measuring vane Rectangular vane, 50 x 98 mm (1.97 x 3.86 inch) Rectangular vane, 50 x 150 mm (1.97 x 5.91 inch) Rectangular vane, 50 x 250 mm (1.97 x 9.84 inch) Rectangular vane, 98 x 150 mm (3.86 x 5.91 inch) Rectangular vane, 98 x 250 mm (3.86 x 9.84 inch) Hinged vane, 65 x 200 mm (2.56 x 7.87 inch)	A B C D E F			
Approvals CSA/FM Dust Ignition Proof, RCM ATEX II 1/2 D, RCM CSA/FM General Purpose, RCM, CE CE, RCM IEC Ex ta/tb IIIC EAC Ex ta/tb IIIC Da/Db	A B C D E F			

Level Measurement

Point level measurement

Rotation paddle switches

SITRANS LPS200

Selection and Ordering data	Article No.	Ord. code
SITRANS LPS200, rigid extension Rotary paddle switch for top mount point level and material detection in bulk solids	7ML5730-	
↗ Click on the Article No. for the online configuration in the PIA Life Cycle Portal.		
Process temperature		
Up to 80 °C (176 °F)	1	
Up to 150 °C (302 °F)	2	
Up to 250 °C (482 °F)	3	
Up to 600 °C (1 112 °F) ¹⁾²⁾	4	
Power supply		
230 V AC, 1 rev/min.	A	
230 V AC, 5 rev/min.	C	
115 V AC, 1 rev/min.	E	
115 V AC, 5 rev/min.	G	
48 V AC, 1 rev/min.	J	
24 V AC, 1 rev/min.	K	
24 V DC, 1 rev/min.	L	
24 V DC, 5 rev/min.	N	
48 V AC, 5 rev/min.	Z	J 1 B
24 V AC, 5 rev/min.	Z	J 1 E
Universal Voltage, 1 rev/min.	Z	J 2 A
Universal Voltage, 1 rev/min., fail-safe	Z	J 2 B
Universal Voltage, 5 rev/min.	Z	J 2 C
Universal Voltage, 5 rev/min., fail-safe	Z	J 2 D
Process connection		
<u>Threaded</u>		
G 1¼" [(BSPP), EN ISO 228-1]	A	
G 1½" [(BSPP), EN ISO 228-1]	B	
1¼" NPT [(Taper), ANSI/ASME B1.20.1]	C	
1½" NPT [(Taper), ANSI/ASME B1.20.1]	D	
<u>Flanged</u>		
DN 32 PN 6, EN 1092-1, flat face ³⁾	E	
DN 100 PN 6, EN 1092-1, flat face ³⁾	F	
DN 100 PN 16, EN 1092-1, flat face	G	
2" ASME 150 lb B16.5, raised face	H	
3" ASME 150 lb B16.5, raised face	J	
4" ASME 150 lb B16.5, raised face	K	
2" Tri-clamp 2" (DN 50) ISO 2852 ⁴⁾	L	

Selection and Ordering data	Article No.	Ord. code
SITRANS LPS200, rigid extension Rotary paddle switch for top mount point level and material detection in bulk solids	7ML5730-	
Process pressure		
Up to 0.5 bar (7.25 psi)	1	
Up to 5 bar (72.5 psi)	2	
Up to 10 bar (145 psi)	3	
Process connection material		
Aluminum ⁵⁾	1	
Stainless steel, threads 303 (1.4305), flanges 321 (1.4541), Tri-clamp 304 (1.4301)	2	
Stainless steel 316L (1.4404) ⁶⁾	3	
Extension material (protection tube)		
Aluminum ⁷⁾⁸⁾	0	
Stainless steel 303 (1.4305) ⁹⁾	1	
Stainless steel 316L (1.4404) ¹⁰⁾¹¹⁾²²⁾	2	
Extension length		
<u>Aluminum</u>		
250 ... 500 mm (9.84 ... 19.69 inch)		A
501 ... 750 mm (19.72 ... 29.53 inch)		B
751 ... 1 000 mm (29.57 ... 39.37 inch)		C
1 001 ... 1 250 mm (39.41 ... 42.21 inch)		D
1 251 ... 1 500 mm (49.25 ... 59.06 inch)		E
1 501 ... 1 750 mm (59.09 ... 68.90 inch)		F
1 751 ... 2 000 mm (68.94 ... 78.74 inch)		G
2 001 ... 2 250 mm (78.78 ... 88.58 inch)		H
2 251 ... 2 500 mm (88.62 ... 98.43 inch)		J
2 501 ... 2 750 mm (98.46 ... 108.27 inch)		K
2 751 ... 3 000 mm (108.31 ... 118.11 inch)		L
3 001 ... 3 250 mm (118.15 ... 127.95 inch)		M
3 251 ... 3 500 mm (127.99 ... 137.80 inch)		N
3 501 ... 3 750 mm (137.83 ... 147.64 inch)		P
3 751 ... 4 000 mm (147.67 ... 157.48 inch)		Q
<u>Stainless steel 303 (1.4305)</u>		
250 ... 500 mm (9.84 ... 19.69 inch)		R
501 ... 750 mm (19.72 ... 29.53 inch)		S
751 ... 1 000 mm (29.57 ... 39.37 inch)		T
1 001 ... 1 500 mm (39.41 ... 59.05 inch)		U
1 501 ... 2 000 mm (59.09 ... 78.74 inch)		V
2 001 ... 2 500 mm (78.78 ... 98.42 inch)		W
2 501 ... 3 000 mm (98.46 ... 118.11 inch)		X
3 001 ... 4 000 mm (118.15 ... 157.48 inch)		Y
<u>Stainless steel 316L (1.4404)</u>		
250 ... 500 mm (9.84 ... 19.69 inch)	Z	P 1 A
501 ... 750 mm (19.72 ... 29.53 inch)	Z	P 1 B
751 ... 1 000 mm (29.57 ... 39.37 inch)	Z	P 1 C
1 001 ... 1 500 mm (39.41 ... 59.05 inch)	Z	P 1 D
1 501 ... 2 000 mm (59.09 ... 78.74 inch)	Z	P 1 E
2 001 ... 2 500 mm (78.78 ... 98.42 inch)	Z	P 1 F
2 501 ... 3 000 mm (98.46 ... 118.11 inch)	Z	P 1 G
3 001 ... 4 000 mm (118.5 ... 157.48 inch)	Z	P 1 H

4

Selection and Ordering data	Article No.	Ord. code
SITRANS LPS200, rigid extension Rotary paddle switch for top mount point level and material detection in bulk solids	7ML5730-	
Measuring vane Boot shaped, 35 x 106 mm (1.34 x 4.17 inch) ¹²⁾ Hinged vane, 65 x 200 mm (2.56 x 7.87 inch) ¹²⁾ Rectangular, 50 x 150 mm (1.97 x 5.91 inch) ¹³⁾ Rectangular, 50 x 250 mm (1.97 x 9.84 inch) ¹³⁾ Rectangular, 98 x 150 mm (3.86 x 5.91 inch) ¹³⁾ Rectangular, 98 x 250 mm (3.86 x 9.84 inch) ¹³⁾ Rectangular, 50 x 98 mm (1.97 x 3.86 inch) ¹³⁾		A B C D E F G
Approvals CSA/FM Dust Ignition Proof, RCM ATEX II 1/2 D, RCM CSA/FM General Purpose, RCM, CE CE, RCM IEC Ex ta/tb IIIC EAC Ex ta/tb IIIC Da/Db		1 2 3 4 5 6
Selection and Ordering data		Order code
Further Designs Please add "-Z" to Article No. and specify Order code(s).		
Total insertion length: Enter the total insertion length in plain text description, max. 4 000 mm (157.48 inch)	Y01	
Stainless steel tag [100 x 45 mm (3.94 x 1.77 inch)]; Measuring-point number/identification (max. 27 characters); specify in plain text	Y14	
Functional Safety (SIL 2). Device suitable for use in accordance with IEC 61508 and IEC 61511. ²⁰⁾²¹⁾	C20	
Heating of enclosure ¹⁴⁾¹⁵⁾	A35	
Signal bulb inserted in M20 cable gland ¹⁴⁾	A20	
Food grade materials (in contact with process), according to 1935/2004/EC, with FDA conform shaft sealing ¹⁶⁾¹⁷⁾	K01	
Optional end of shaft seal for stability and ingress protection		
Max. temperature 80 °C (176 °F)	P06	
Max. temperature 150 °C (302 °F)	P07	
Max. temperature 250 °C (482 °F)	P08	
Max. temperature 600 °C (1 112 °F)	P09	
Sliding sleeve (standard, max. pressure 0.5 bar) ¹⁴⁾¹⁸⁾	P12	
Sliding sleeve (pressure tight, for over-pressure application starting from 1 bar max., dependent on pressure option ordered) ¹⁹⁾	P13	
Operating Instructions	Article No.	
Multi-language Note: The Operating Instructions should be ordered as a separate line on the order. All literature is available to download for free, in a range of languages, at http://www.siemens.com/processinstrumentation/documentation	A5E34210883	
Spare Parts		
Replacement vane, boot shape, 35 x 106 mm (1.38 x 4.17 inch)	7ML1830-1KH	
Hinged vane, 98 x 200 mm (3.86 x 7.87 inch)	7ML1830-1KJ	

- 1) Available with approval options 3 and 4, up to max 0.5 bar
- 2) Not available with process connections A, C, E.
- 3) Available with process pressure options 1 and 2 only.
- 4) Available with process temperature 1 only.
- 5) Available with process connections A ... E only, with process pressure option 1 and process temperature option 1 only.
- 6) Available with process connection options B, D, F ... L and measuring vane option A.
- 7) Available with process pressure 1 and process temperature 1 only.
- 8) Available with extension length options A ... Q only.
- 9) Available with extension length options R ... Y only.
- 10) Available with process connection options B, D, F ... L and measuring vane A, process connection material 3. Available only with extension length options P1A ... P1H only.
- 11) Only available with seal at tube end options P06 ... P09.
- 12) Add 16 mm (0.63 inch) to extension length.
- 13) Available with process connections F, G, H, J, K only.
- 14) Available with approval option 4 only.
- 15) Available with power supply options A,C, E, G, J, K, L, N, J1B, J1D, J1E, J2A, J2C only.
- 16) Available when ordered with ingress protection seal options P06 ... P09 only.
- 17) Available up to 250 °C (482 °F). This option does not automatically implement a food conform design.
- 18) Available with process pressure option 1 only.
- 19) Available up to 250 °C (482 °F).
- 20) Available with Power supply options J2A and J2C only.
- 21) Available with Approval options 1, 2, 3, 4, and 5 only. Approvals 1 and 3 with FM only.
- 22) Internal probe construction is 1.4305, add seal option P09 to prevent ingress.

Level Measurement

Point level measurement
Rotation paddle switches

SITRANS LPS200

Dimensional drawings

Standard model: compact version

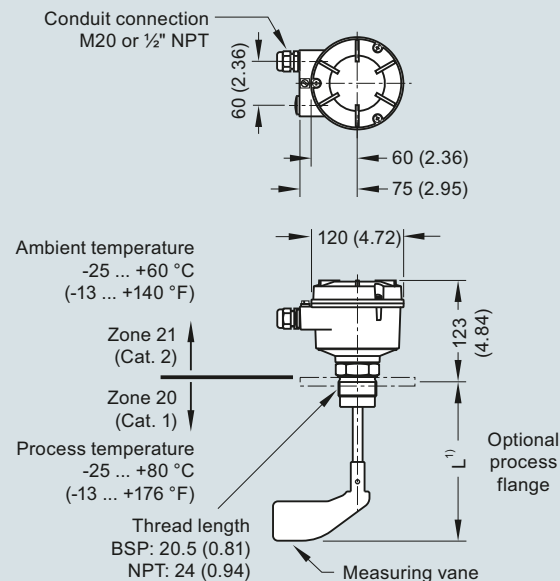

High temperature model: compact version

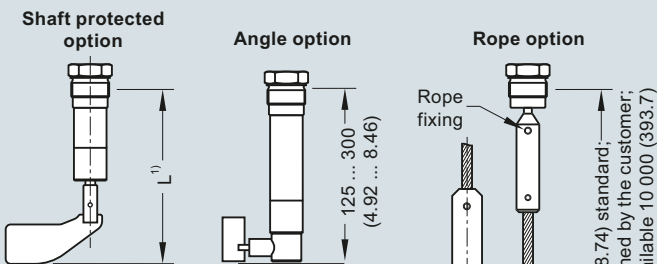
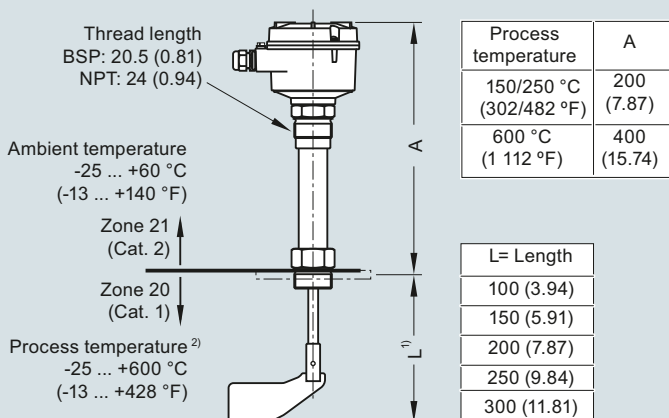

Measuring vanes

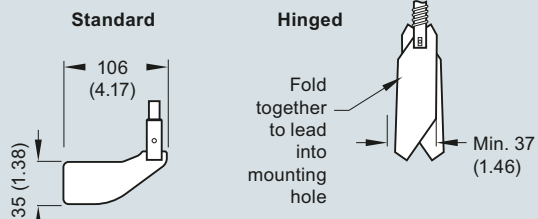

Rectangular

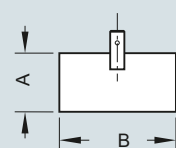

Rectangular vane options

	A	B
	50 (1.97)	98 (3.86)
	50 (1.97)	150 (5.90)
	50 (1.97)	250 (9.84)
	98 (3.86)	150 (5.90)
	98 (3.86)	250 (9.84)

- For 35 x 106 mm boot shaped and 98 x 200 mm hinged measuring vanes, add 16 mm to extension length.
- For use with all approval options except CSA class II. See manual for more details.

Notes

For heavy material, only top mounting of paddle switch is recommended.
Compact LPS200 is recommended for side mounting on bins for low or intermediate material levels.

Vane	Completely covered with material		Covered up to 10 cm (3.93 inch) with material	
	Spring adjustment		Spring adjustment	
	Light	Central (factory setting)	Light	Central (factory setting)
Boot shaped 35 x 106 mm	200 g/l (12.5 lb/ft ³)	300 g/l (18.7 lb/ft ³)	100 g/l (6.2 lb/ft ³)	150 g/l (9.4 lb/ft ³)
Boot shaped 28 x 98 mm	300 g/l (18.7 lb/ft ³)	500 g/l (31.2 lb/ft ³)	150 g/l (9.4 lb/ft ³)	150 g/l (9.4 lb/ft ³)
Rectangular 50 x 98 mm	300 g/l (18.7 lb/ft ³)	500 g/l (31.2 lb/ft ³)	150 g/l (9.4 lb/ft ³)	250 g/l (15.6 lb/ft ³)
Rectangular 50 x 150 mm	80 g/l (5.0 lb/ft ³)	120 g/l (7.5 lb/ft ³)	40 g/l (2.5 lb/ft ³)	60 g/l (3.7 lb/ft ³)
Rectangular 50 x 250 mm	30 g/l (1.9 lb/ft ³)	50 g/l (3.1 lb/ft ³)	15 g/l (0.9 lb/ft ³)	25 g/l (1.6 lb/ft ³)
Rectangular 98 x 150 mm	30 g/l (1.9 lb/ft ³)	50 g/l (3.1 lb/ft ³)	15 g/l (0.9 lb/ft ³)	25 g/l (1.6 lb/ft ³)
Rectangular 98 x 250 mm	20 g/l (1.2 lb/ft ³)	30 g/l (1.9 lb/ft ³)	15 g/l (0.9 lb/ft ³)	15 g/l (0.9 lb/ft ³)
Hinged 98 x 200 mm	70 g/l (4.4 lb/ft ³)	100 g/l (6.2 lb/ft ³)	35 g/l (2.2 lb/ft ³)	50 g/l (3.1 lb/ft ³)

SITRANS LPS200, dimensions in mm (inch)

Circuit diagrams

AC or DC version

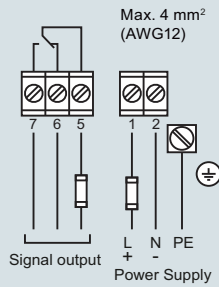

Power supply:

AC version:
24 V or 48 V or 115 V or 230 V 50/60 Hz max. 4 VA
All voltages ± 10 %¹⁾
Supply voltage as selected.
External fuse: max 10 A, fast or slow, HBC, 250 V

DC version:
24 V DC ± 15 %¹⁾ max. 2.5 W
External fuse: not required

¹⁾ Including ±10% of EN 61010

Signal output:

Micro switch, SPDT contact
max. 250 V AC, 5 A, non inductive
max. 30 V DC, 4 A, non inductive
External fuse: max 10 A, fast or slow, HBC, 250 V

Universal voltage (DPDT relay)*

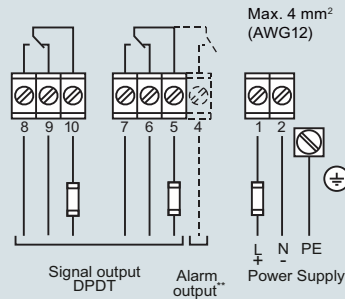

* See manual for universal voltage with SIL.

** With option Fail safe alarm (rotation control).
Contact open when de-energised.
Fail safe alarm switching and timing behaviour:
If the vane is not covered, the rotating vane shaft will send pulses at 20 second intervals.
In case of fault, the pulses are missed.
After 30 seconds, the alarm relay will open.

Signal output: delay

Sensor covered -> free
Factory setting = 3 sec

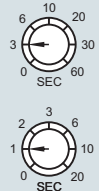

Sensor covered -> covered
Factory setting = 1 sec

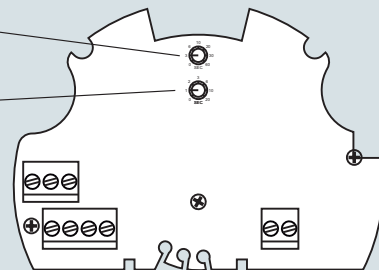

SITRANS LPS200 connections