

# VM PUMPAR

## Calio S 25-40

EEL≤0,23



I×230 V, 50 Hz, IEC38	P1[W]	I[A]
Auto min.	4,00	0,05
Auto max.	23,1	0,23
Speed 1 - 4	6,9 - 23,5	0,084 - 0,263
Temperature Range (TF 95 - CEN 335-2-51)		
Water temp max. [°C]	95	-
Water temp min. [°C]	2	-
Ambient temp max. [°C]	40	-
NPSH [bar]		
	80°C - 0,5	95°C - 1,5
Kg. (net)		
	2,8	

### Installation

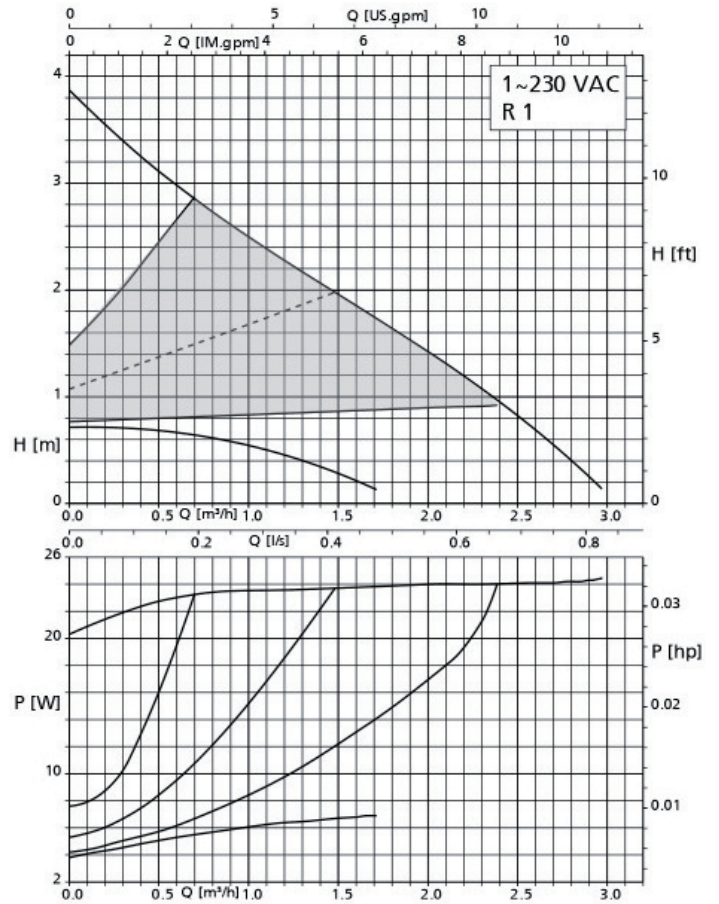
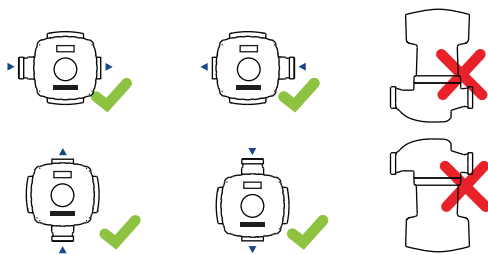

### Settings

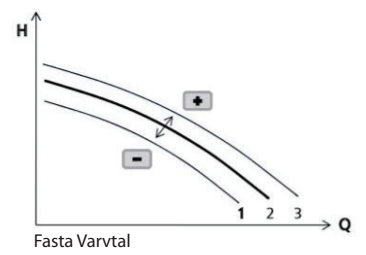
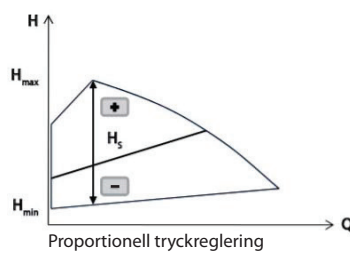
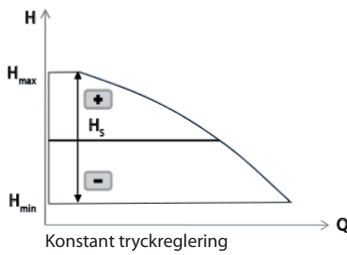

### Dimensions

Model	H(mm)	G	R
25-40	130/180	1½"	1"

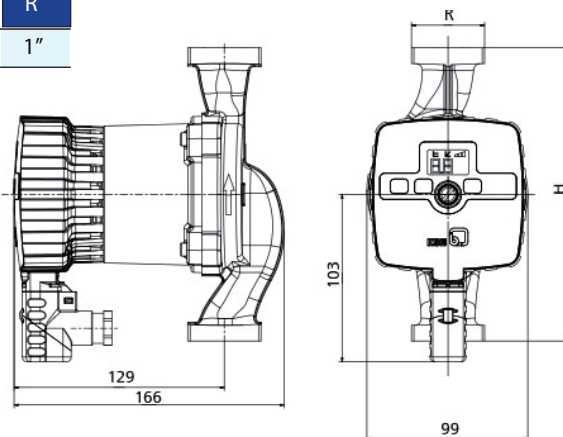

### Electrical connection

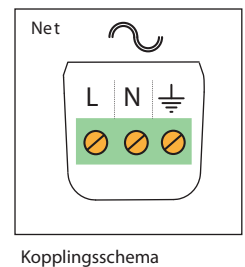

VM Pumpar AB reserve the right to change the product without prior notice and take no responsibility for inaccuracies or misprints.