

VM PUMPAR

Calio 30-60

EEI≤0,23



Ix230 V, 50Hz, IEC38	PI [W]	I [A]
Auto min.	8	0,10
Auto max.	100	0,80

Water temp max. [°C]	110	
Water temp min. [°C]	-10	
Ambient temp max. [°C]	40	

NPSH [bar]	80°C - 0,5	95°C - 1,5
Kg. (net)	4,8	

Installation

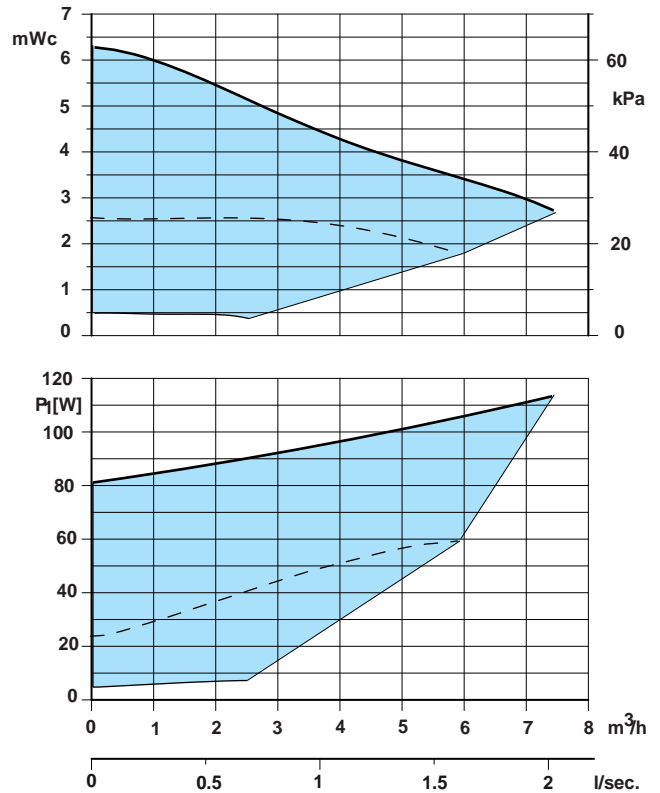
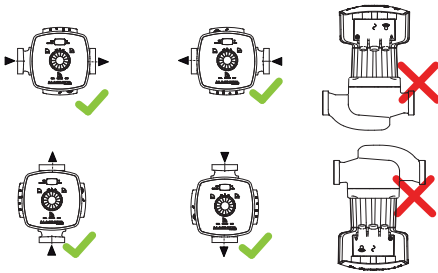

Electrical connection

Function	Symbol	Terminal Pair	Terminal cross section	Terminal ID
Power supply I~230 VAC, 50/60 Hz			1.5 mm ²	3 - PE 2 - N 1 - L
General fault message			1.5 mm ²	3 - NO 2 - COM 1 - NC
External analog signal 0 - 10 VDC	0-10V		1.5 mm ²	1 - 0 2 - Uin
External signal for start/stop of pump (terminalpair supplied bridged)	RUN		1.5 mm ²	1 - 0 2 - R
Modbus	COM		1.5 mm ²	3 - G 2 - A 1 - B
Multi pump operation	DUAL		1.5 mm ²	3 - G 2 - A 1 - B

Settings

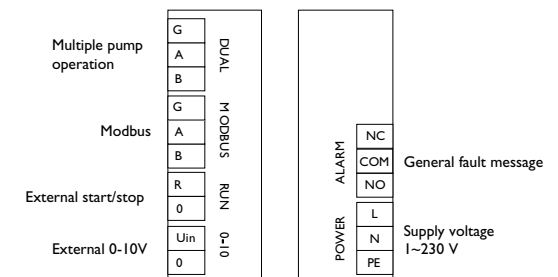
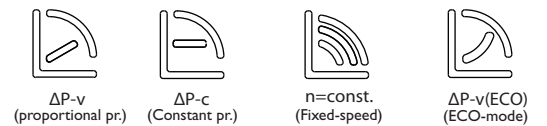

Dimensions

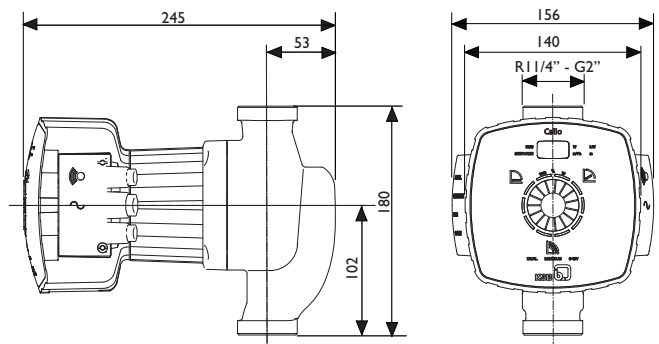

VM Pumpar AB reserve the right to change the product without prior notice and take no responsibility for inaccuracies or misprints.

Calio 30-60, ECO

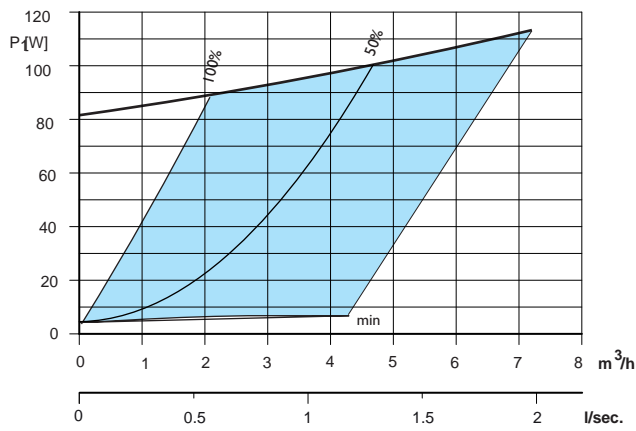
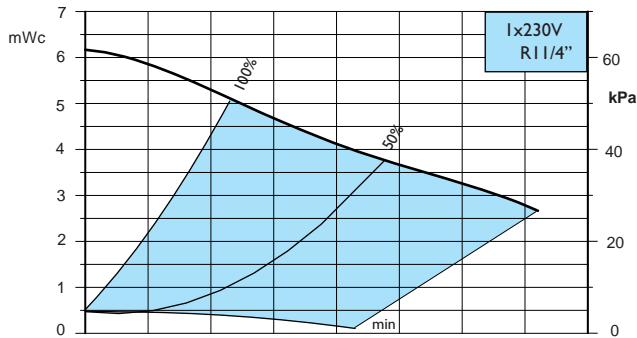

Calio 30-60, Δ pv

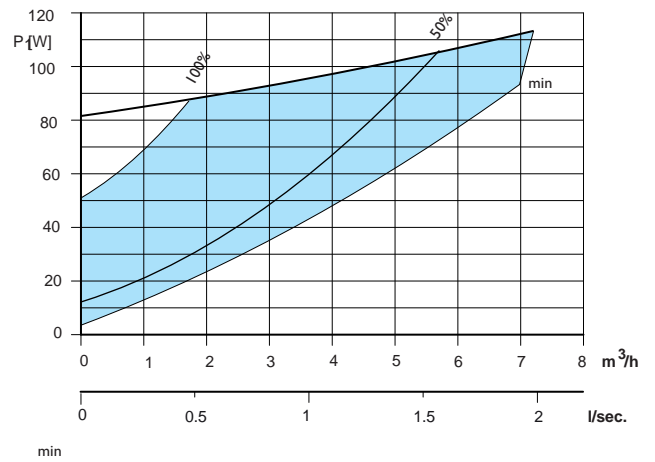
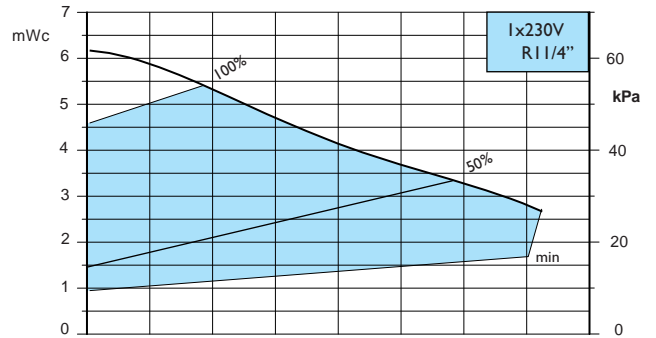

Calio 30-60, Δpc

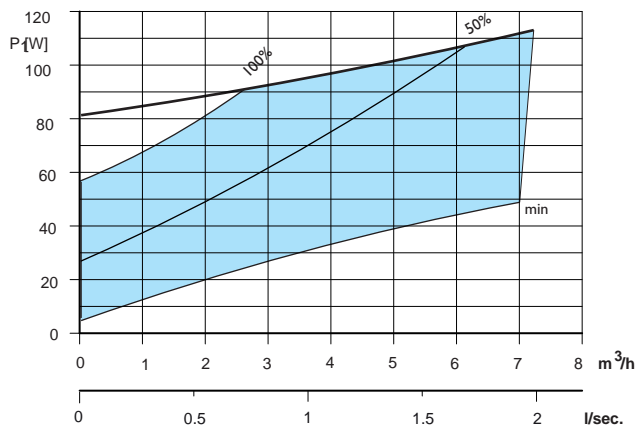
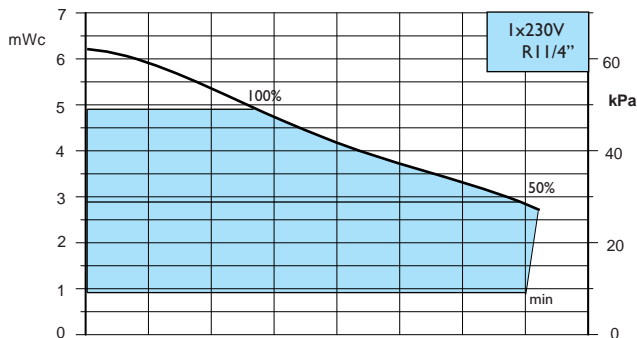

Calio 30-60, Boost

