

I×230 V, 50Hz, IEC38	PI [W]	I [A]
Auto min.	25	0,30
Auto max.	550	3,0

Temperature Range (TF 110 - CEN 335-2-51)

Water temp max. [°C]	110	
Water temp min. [°C]	-10	
Ambient temp max. [°C]	40	

NPSH [bar]	80°C - 0,5	95°C - 1,5
Kg. (net)	21	

Installation

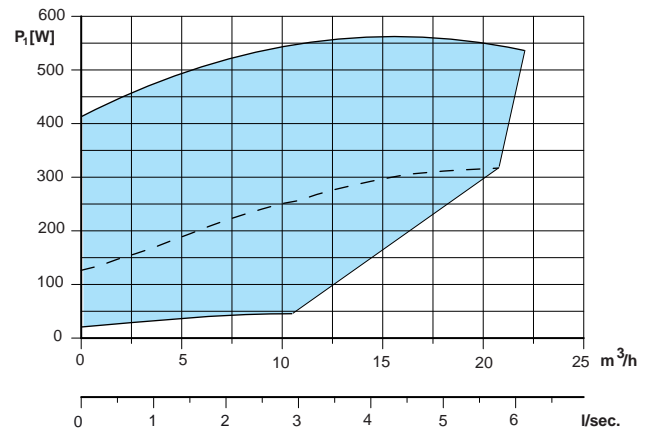
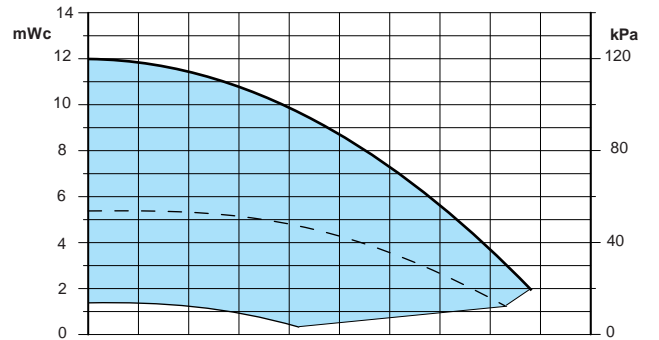
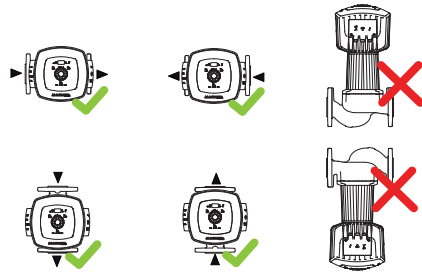

Electrical connection

Function	Symbol	Terminal Pair	Terminal cross section	Terminal ID
Power supply 1~230 VAC, 50/60 Hz			1.5 mm ²	3 - PE 2 - N 1 - L
General fault message			1.5 mm ²	3 - NO 2 - COM 1 - NC
External analog signal 0 - 10 VDC	0-10V		1.5 mm ²	1 - 0 2 - Uin
External signal for start/stop of pump (terminalpair supplied bridged)	RUN		1.5 mm ²	1 - 0 2 - R
Modbus	COM		1.5 mm ²	3 - G 2 - A 1 - B
Multi pump operation	DUAL		1.5 mm ²	3 - G 2 - A 1 - B
Service relay			1.5 mm	3 - NO 2 - COM 1 - NC

Settings

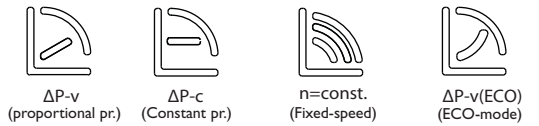

Multiple pump operation

Modbus

External start/stop

External 0-10V

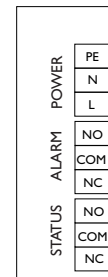
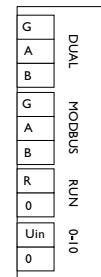

Dimensions

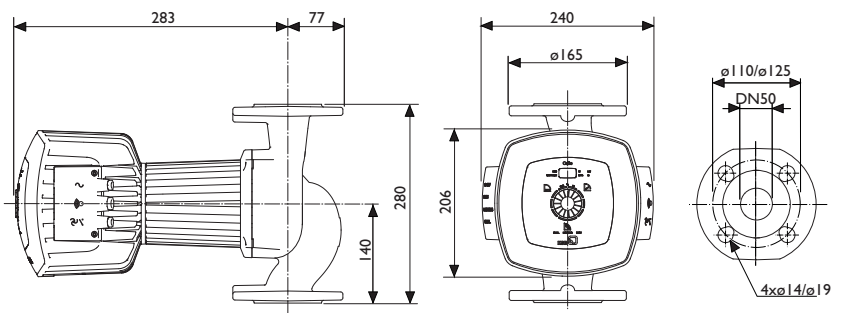

VM Pumphar AB reserve the right to change the product without prior notice and take no responsibility for inaccuracies or misprints.

Calio 50-120, ECO

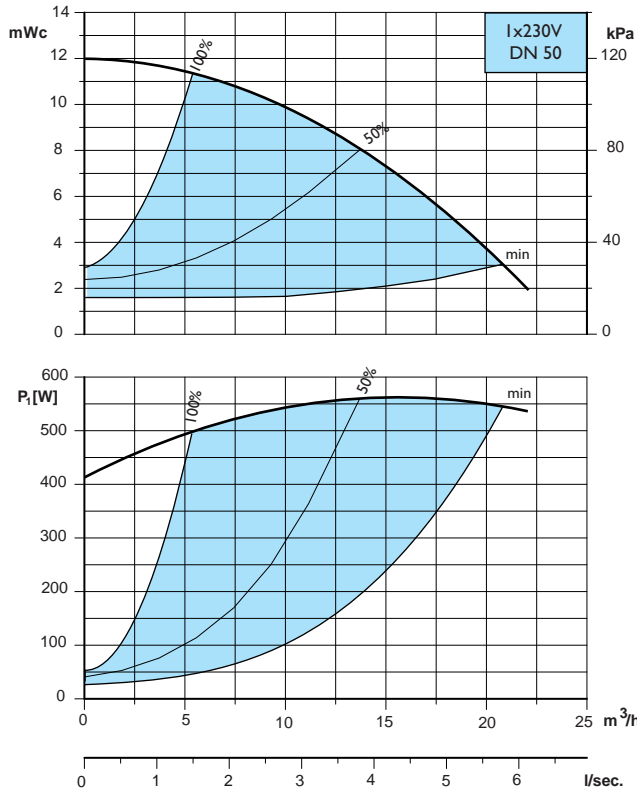

Calio 50-120, Δ pv

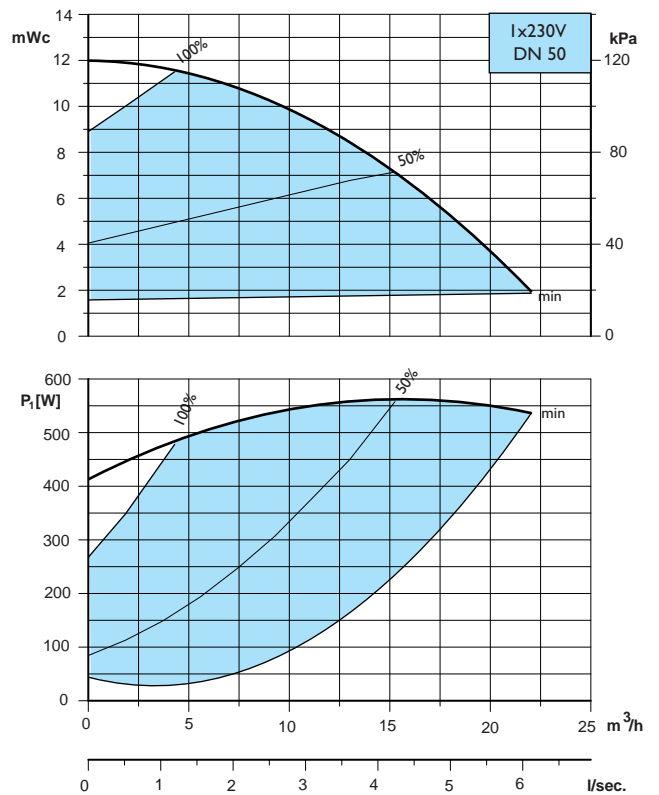

Calio 50-120, Δ pc

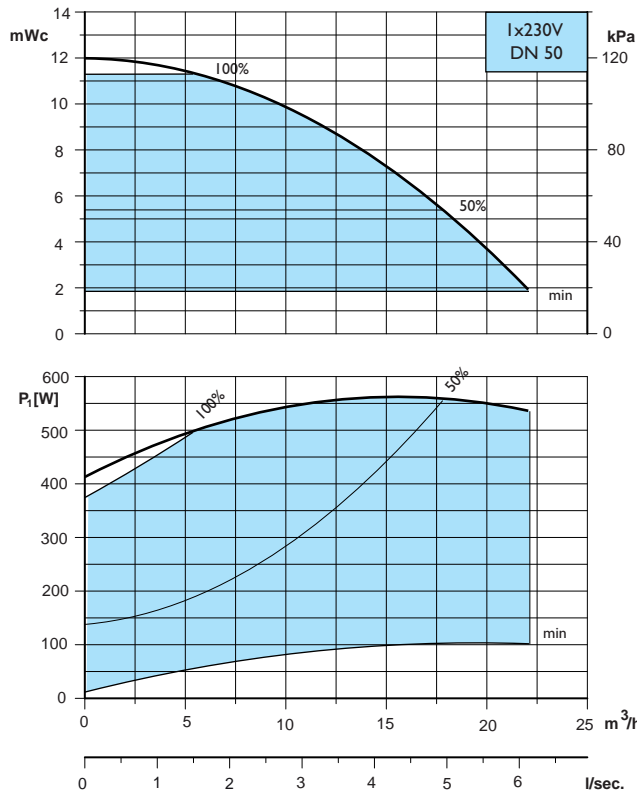

Calio 50-120, Boost

