

Note that all unique customer requirements (i.e tolerance) need to be verified thru Alfa Laval.

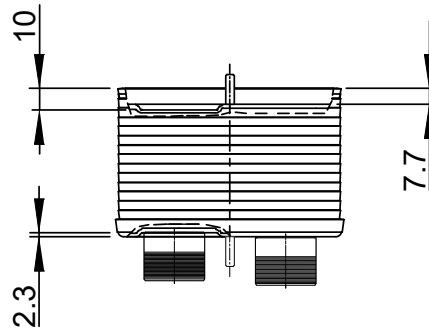
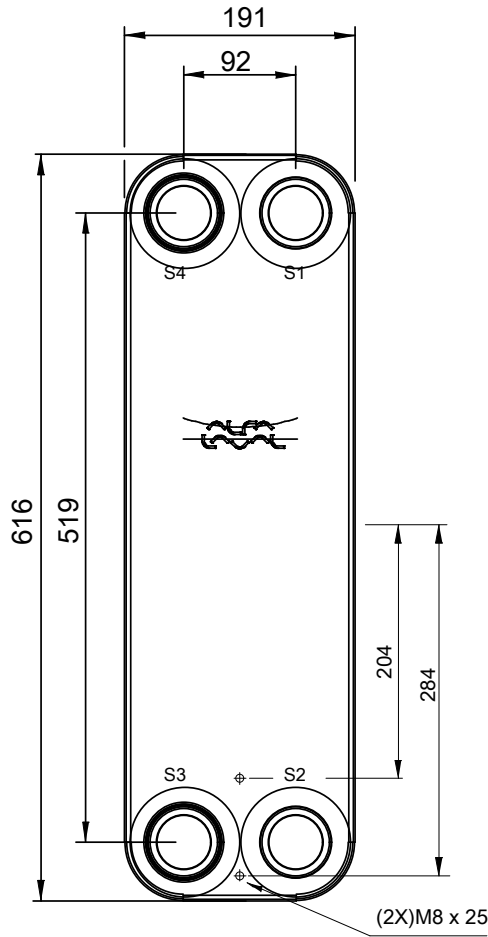
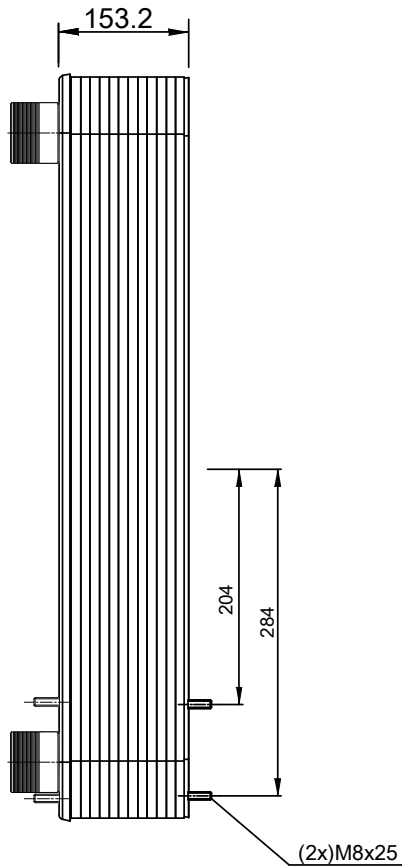
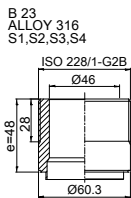

HEATING SURFACE m²
 NETWEIGHT 25.3 kg
 OPERATING WEIGHT kg
 PLATE MATERIAL ALLOY 316
 PLATE GROUPING 1*26H/1*27H

ALL DIMENSIONS IN MILLIMETERS

SIDE	MEDIA	INLET	TEMP. °C	OUTLET	TEMP. °C	FLOW RATE	PRESSURE DROP	LIQUID VOL.
1	Water	S1	°C	S2	°C	kg/h	kPa	5.7 dm ³
2	Water	S3	°C	S4	°C	kg/h	kPa	5.5 dm ³

PRESSURE VESSEL APPROVAL

PED

CB110-54H (3287101559)

www.alfalaval.com

CUSTOMER NAME / REF. NO.

TOTAL LENGTH 216 mm
 TOTAL WIDTH 191 mm
 TOTAL HEIGHT 616 mm

COMPANY / REF.
 Alfa Laval Nordic AB



4/23/2019
 REV 0