

Note that all unique customer requirements (i.e tolerance) need to be verified thru Alfa Laval.

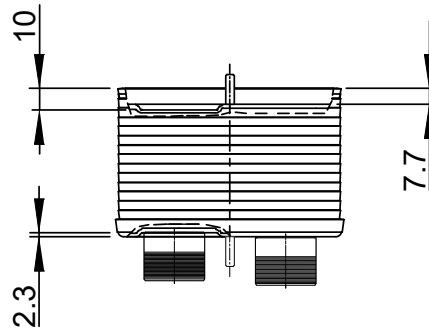
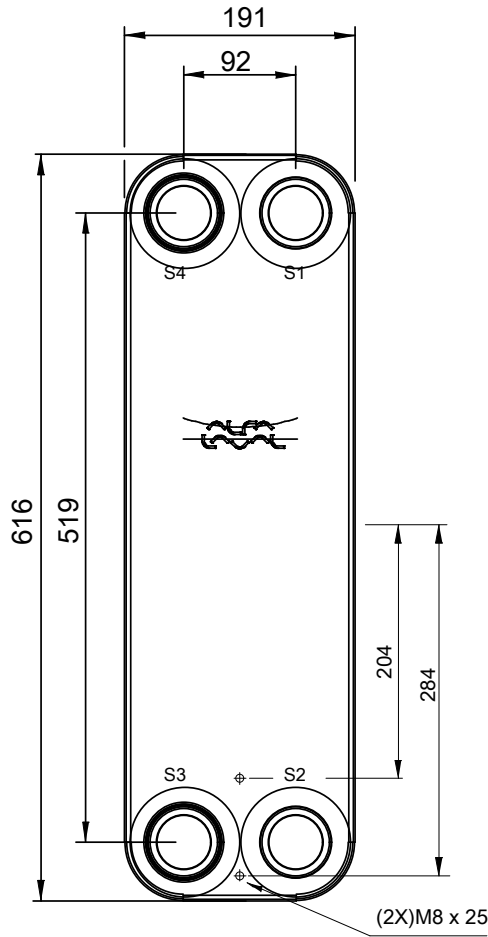
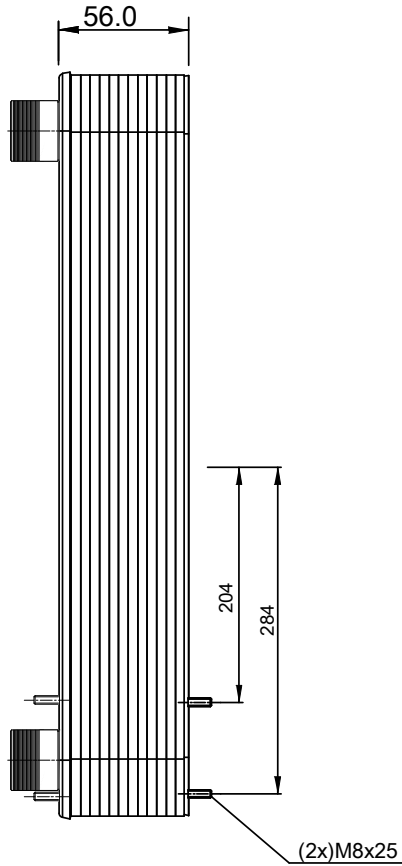
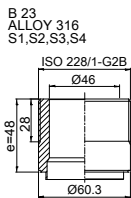

HEATING SURFACE m<sup>2</sup>  
 NETWEIGHT 12.1 kg  
 OPERATING WEIGHT kg  
 PLATE MATERIAL ALLOY 316  
 PLATE GROUPING 1\*7ML/1\*8MH

ALL DIMENSIONS IN MILLIMETERS

SIDE	MEDIA	INLET	TEMP. °C	OUTLET	TEMP. °C	FLOW RATE	PRESSURE DROP	LIQUID VOL.
1	Water	S1	°C	S2	°C	kg/h	kPa	1.7 dm <sup>3</sup>
2	Water	S3	°C	S4	°C	kg/h	kPa	1.5 dm <sup>3</sup>

PRESSURE VESSEL APPROVAL

PED

CB110-16M (3287101587)

[www.alfalaval.com](http://www.alfalaval.com)

CUSTOMER NAME / REF. NO.

TOTAL LENGTH 119 mm  
 TOTAL WIDTH 191 mm  
 TOTAL HEIGHT 616 mm

COMPANY / REF.  
 Alfa Laval Nordic AB



4/23/2019  
 REV 0