

Note that all unique customer requirements (i.e tolerance) need to be verified thru Alfa Laval.

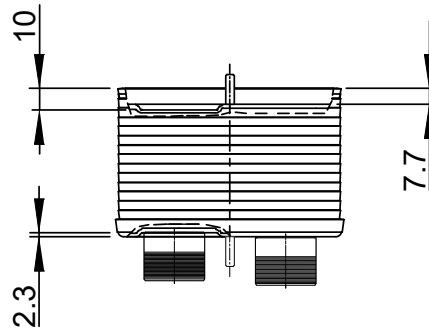
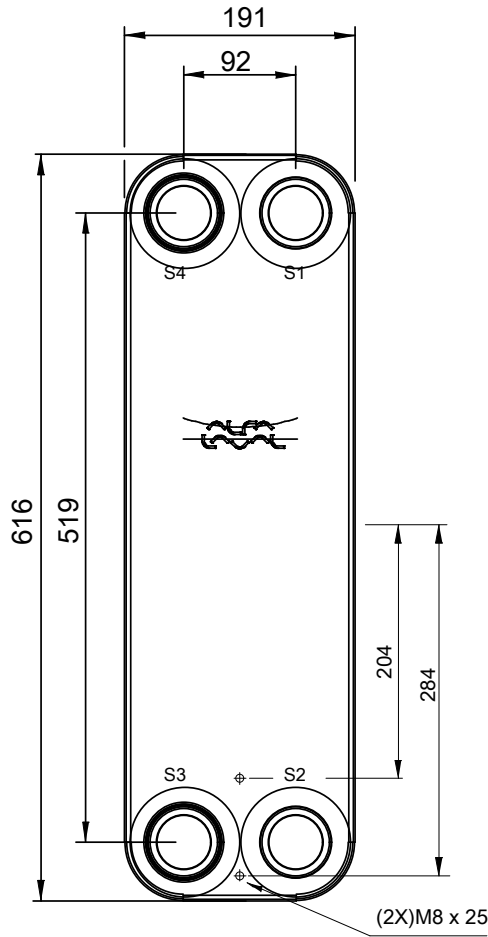
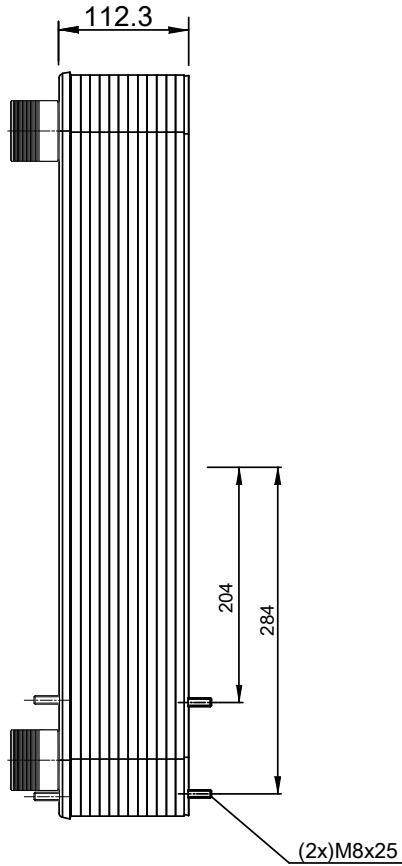
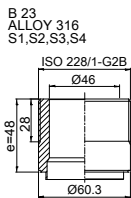

HEATING SURFACE m²
 NETWEIGHT 19.7 kg
 OPERATING WEIGHT kg
 PLATE MATERIAL ALLOY 316
 PLATE GROUPING 1*18L/1*19L

ALL DIMENSIONS IN MILLIMETERS

SIDE	MEDIA	INLET	TEMP. °C	OUTLET	TEMP. °C	FLOW RATE	PRESSURE DROP	LIQUID VOL.
1	Water	S1	°C	S2	°C	kg/h	kPa	4.0 dm ³
2	Water	S3	°C	S4	°C	kg/h	kPa	3.8 dm ³

PRESSURE VESSEL APPROVAL

PED

CB110-38L (3287101602)

www.alfalaval.com

CUSTOMER NAME / REF. NO.

TOTAL LENGTH 175 mm
 TOTAL WIDTH 191 mm
 TOTAL HEIGHT 616 mm

COMPANY / REF.
 Alfa Laval Nordic AB



4/23/2019
 REV 0