

Note that all unique customer requirements (i.e tolerance) need to be verified thru Alfa Laval.

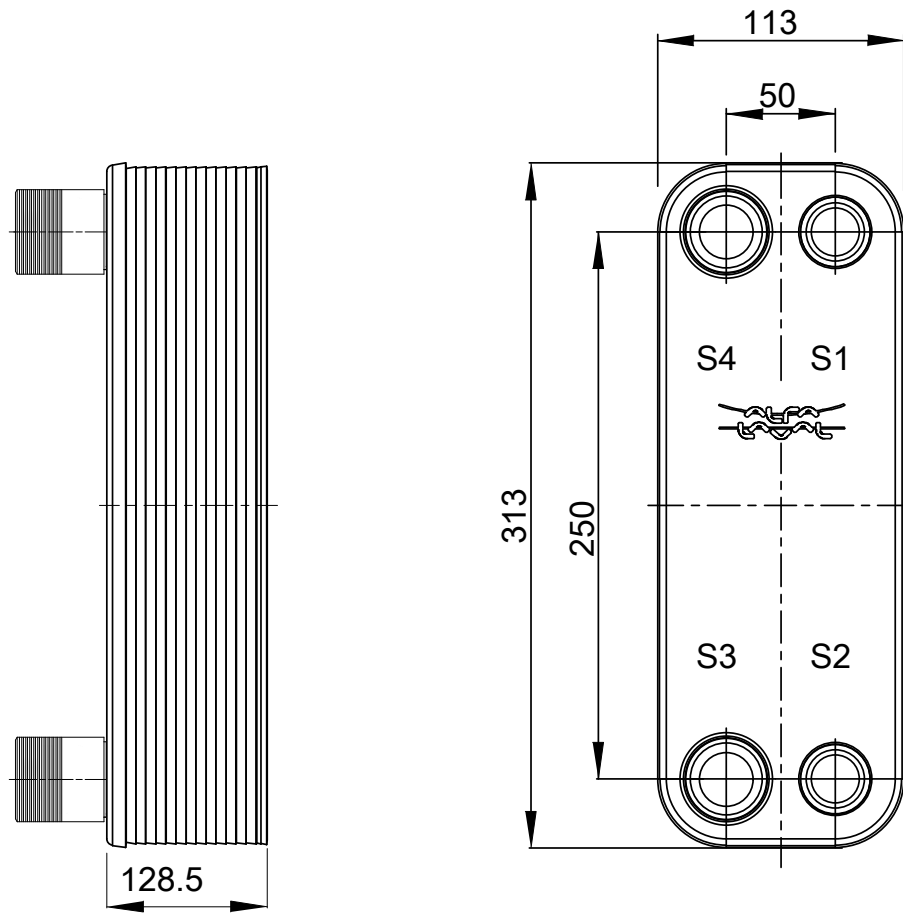
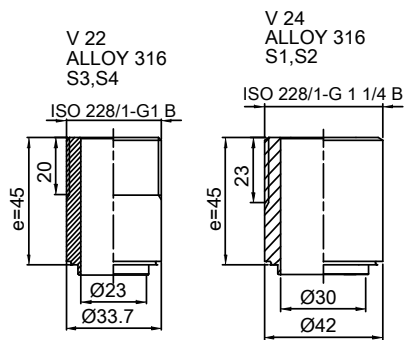

HEATING SURFACE m<sup>2</sup>  
 NETWEIGHT 7.5 kg  
 OPERATING WEIGHT kg  
 PLATE MATERIAL ALLOY 316  
 PLATE GROUPING 1\*24L/1\*25L

T1 T2 T3 T4 locations on back side correspond to S1 S2 S3 S4 on front side

ALL DIMENSIONS IN MILLIMETERS

SIDE	MEDIA	INLET	TEMP. °C	OUTLET	TEMP. °C	FLOW RATE	PRESSURE DROP	LIQUID VOL.
1	Water	S1	°C	S2	°C	kg/h	kPa	1.4 dm <sup>3</sup>
2	Water	S3	°C	S4	°C	kg/h	kPa	1.3 dm <sup>3</sup>

PRESSURE VESSEL APPROVAL

PED

CB30-50L (3287083381)

www.alfalaval.com

CUSTOMER NAME / REF. NO.

TOTAL LENGTH 174 mm  
 TOTAL WIDTH 113 mm  
 TOTAL HEIGHT 313 mm

COMPANY / REF.  
 Alfa Laval Nordic AB



4/23/2019  
 REV 0