

Merika® HT PP-kulmayhde 110 x 45°

Merika nro 2168 ja BK2168

10.02.2022/ PJK

VER 1.0

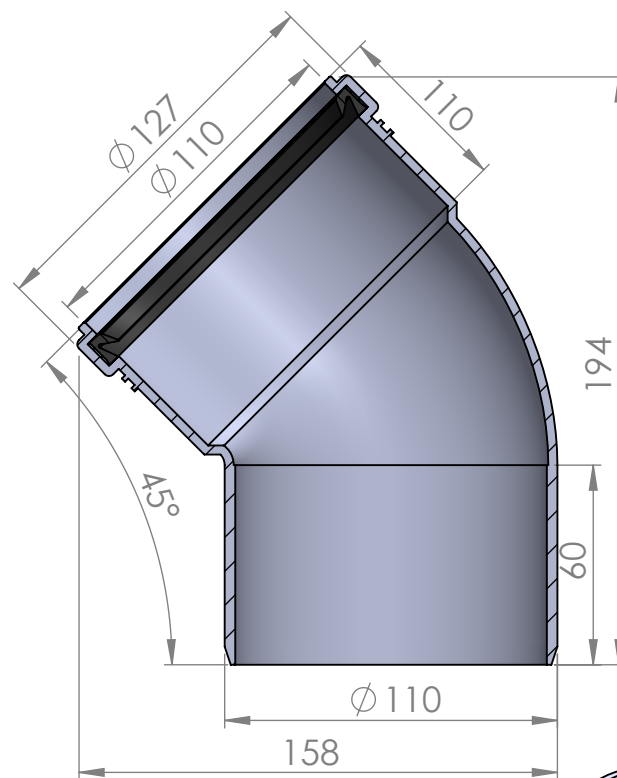
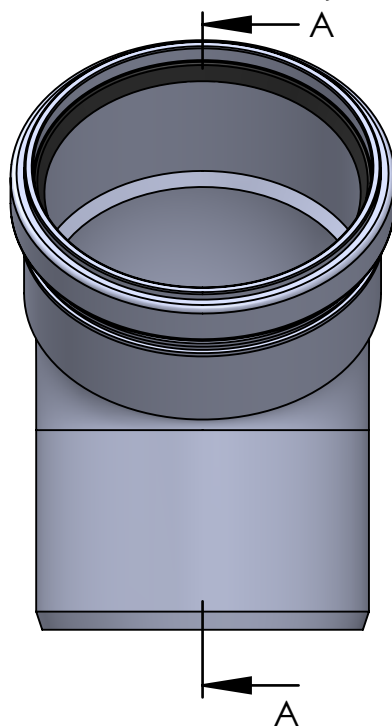
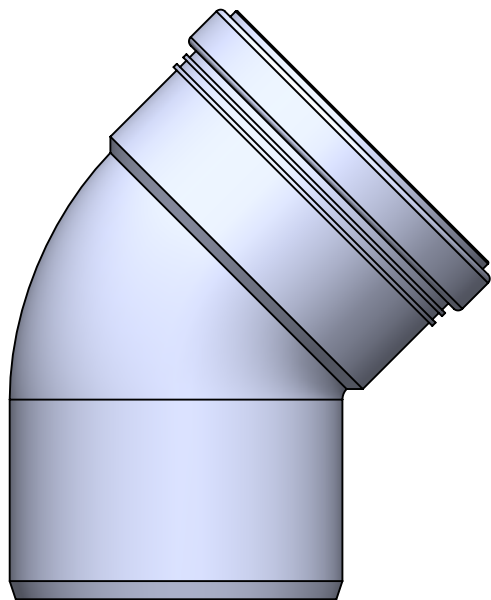

SECTION A-A
SCALE 1 : 2.5

