

Original instructions

**PA3DC/PA4DC
PA3DXT/PA4DXT**

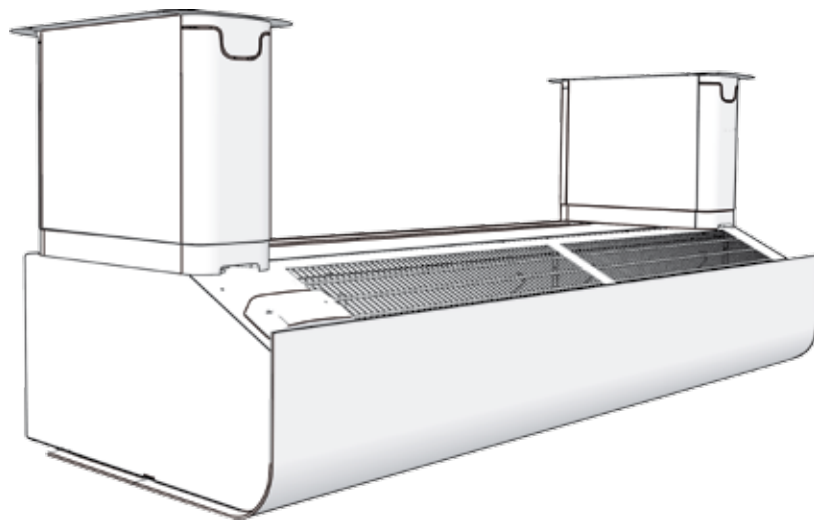



- Installatören är ansvarig för att lämplig metod och infästningsmaterial används.
- The installer must ensure that the appropriate method and mounting materials are used
- Installatøren skal påse at riktig fremgangsmåte og installasjonsmateriell blir brukt.
- Der Installateur muss sicherstellen, dass eine adäquate Installationsmethode und geeignete Installationsmaterialien zur Anwendung kommen.
- L'installateur doit s'assurer que la méthode et le matériel d'installation utilisés conviennent.
- El instalador debe asegurarse de que se utilizan el método y materiales de instalación apropiados
- De installateur dient erop toe te zien dat de juiste methode en installatiematerialen worden gebruikt.
- Instalator powinien dopilnować, aby użyto odpowiedniej metody i materiałów montażowych.
- L'installatore deve assicurarsi che vengano utilizzati il metodo e i materiali di installazione adeguati.
- При монтаже соблюдайте рекомендуемый порядок сборки и используйте приложенные монтажные элементы

PA3DC / PA4DC

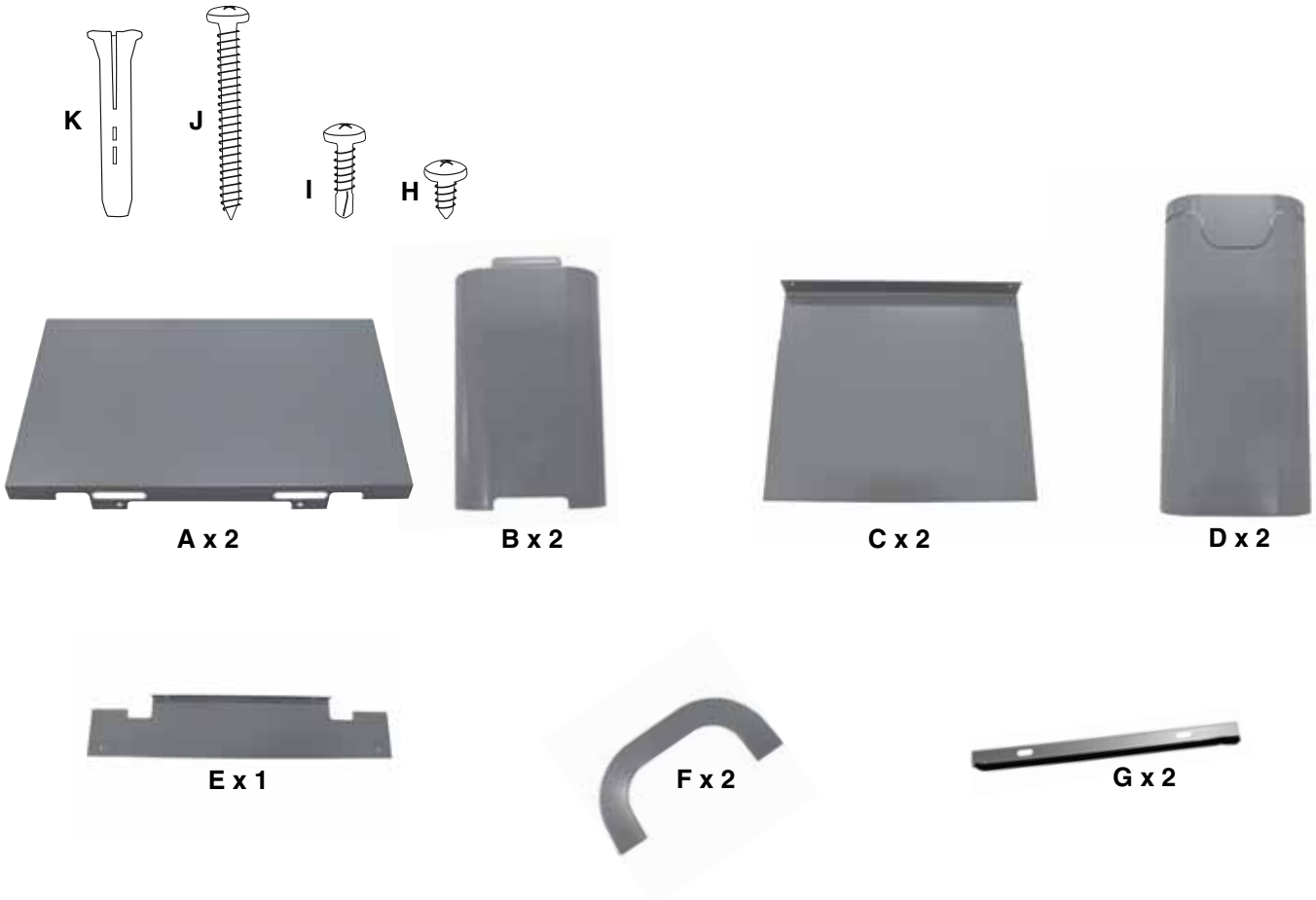

PA3DXT / PA4DXT



PA3DC / PA4DC + PA34TR

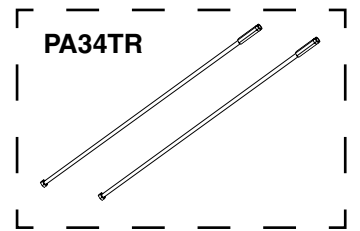

1 2 x A + 2 x B

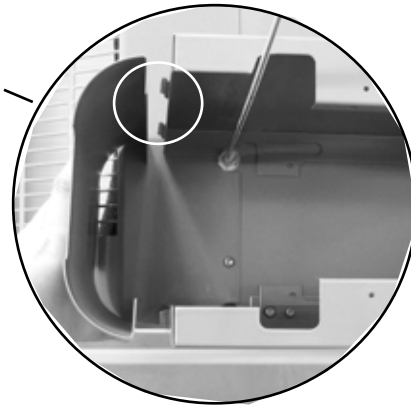

2

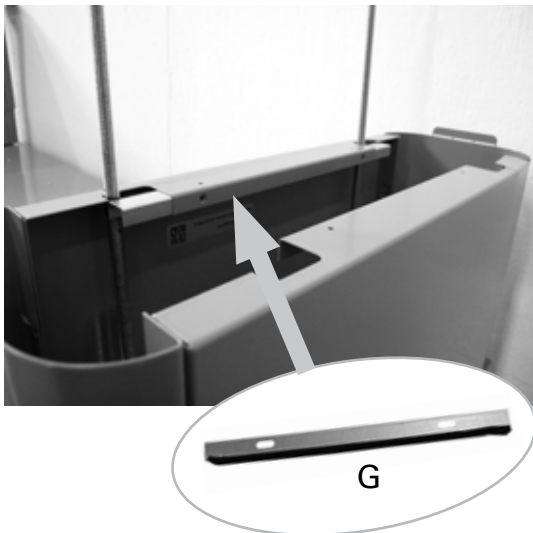

3

2 x I



PA3DXT / PA4DXT

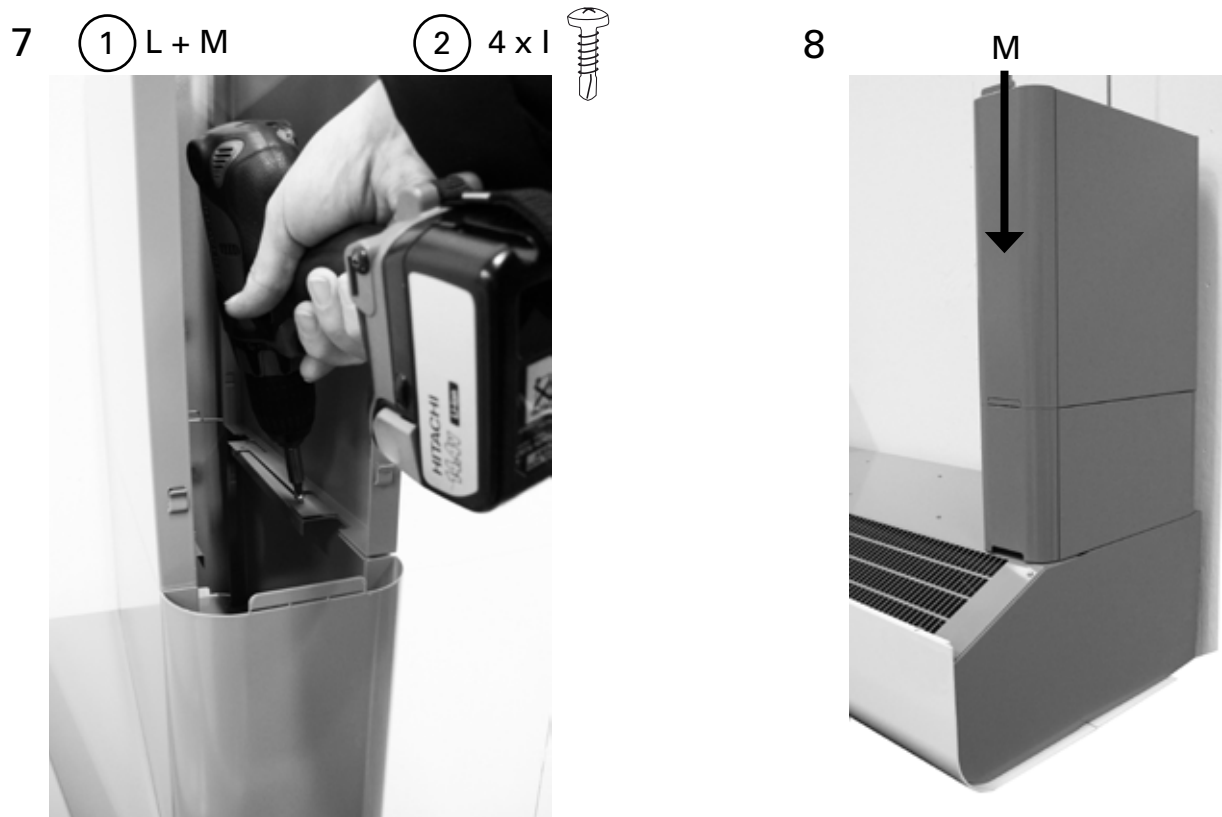
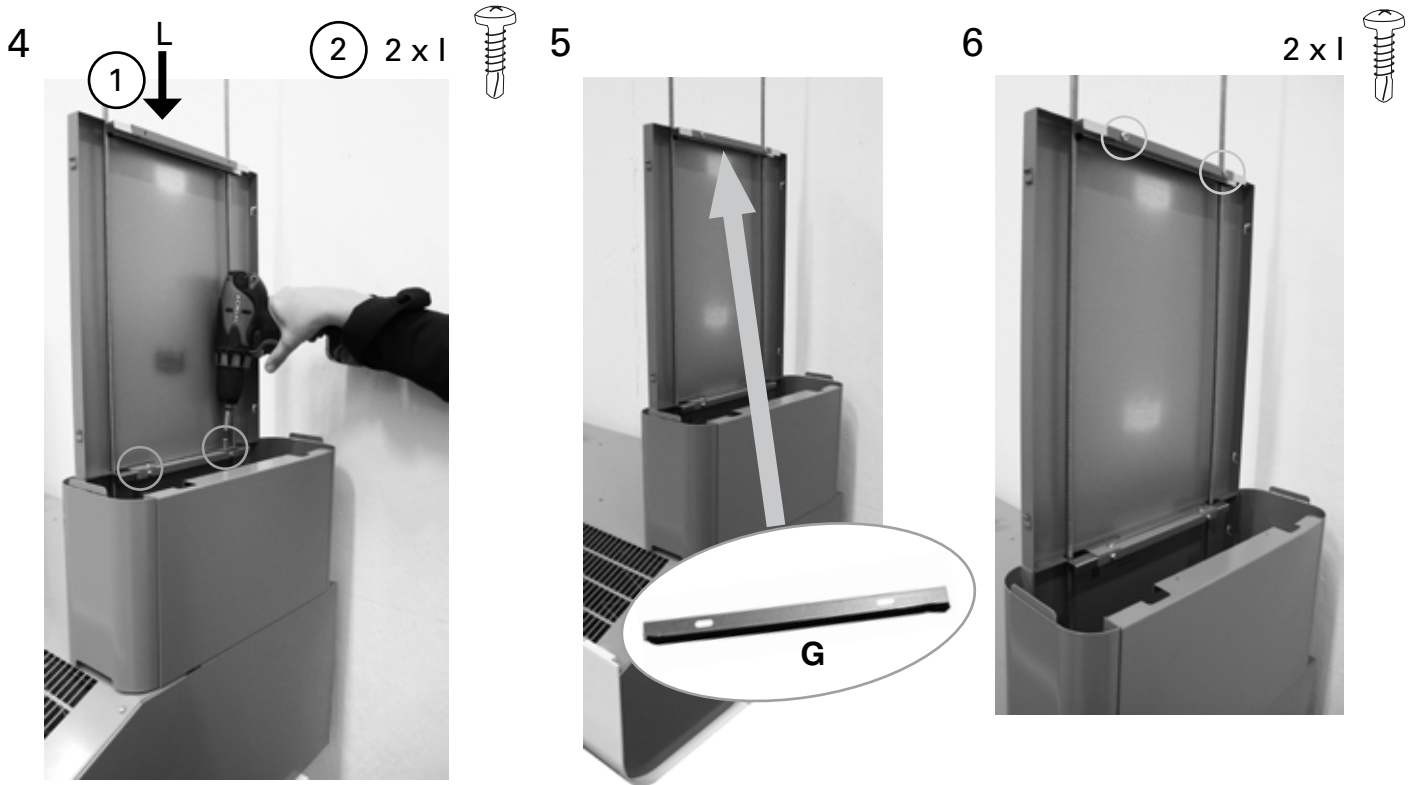

Forts. s.5 fig 4.
 Cont. p.5 fig 4
 Forts. s.5 fig. 4
 Forts. S.5, Abb. 4
 продолжение со стр.5, рис. 4

Suite de la page 5 fig 4
 Continúa de la pág. 5 figura 4
 Vervolg van p. 5, fig. 4
 Kont. ze str. 5 rys. 4
 Segue da p. 5 fig. 4

4

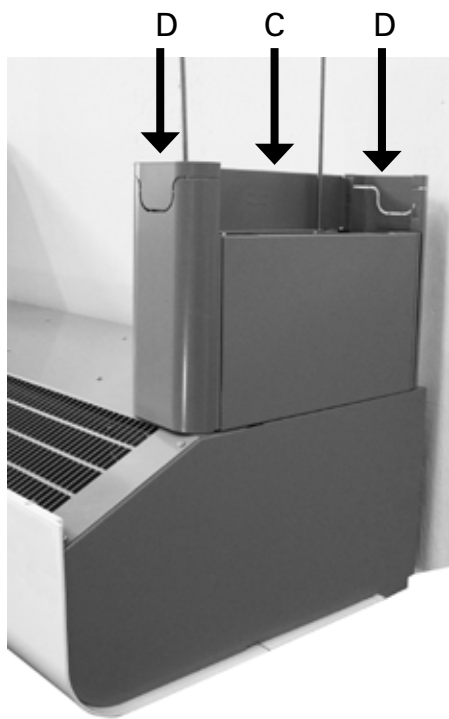
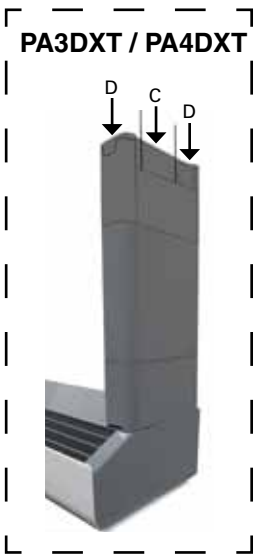

5

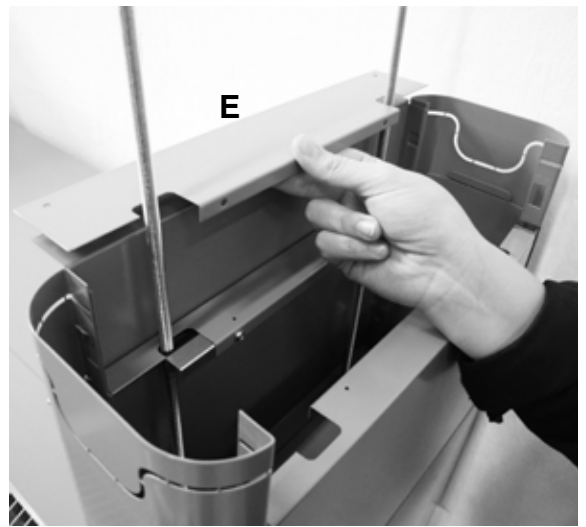

6



2 x F + 2 x H 

7

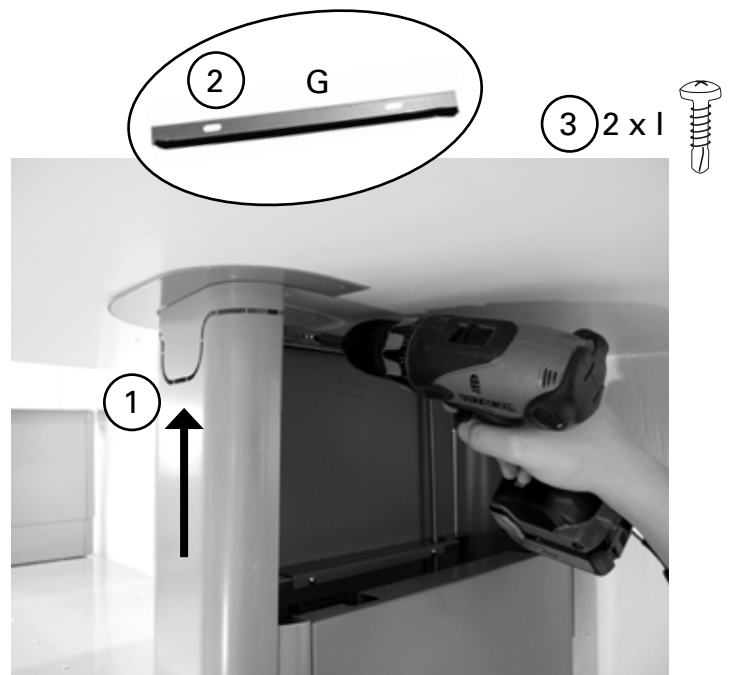

8



9

2 x H 

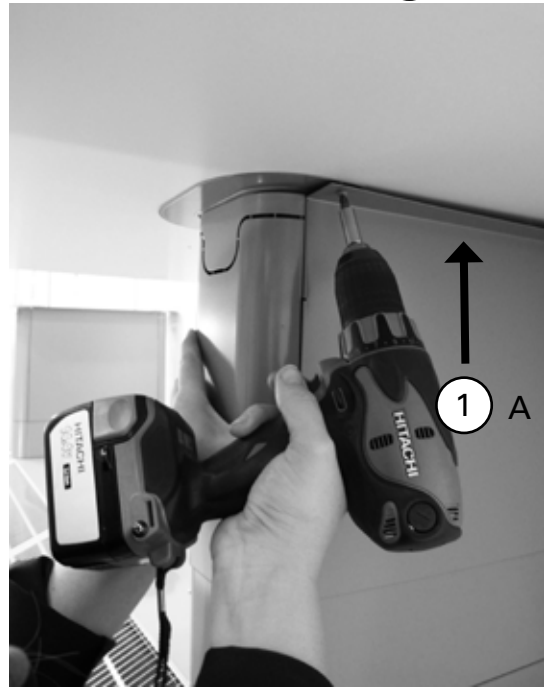

10



 2 x

11



PA3DC / PA4DC + PA3WS / PA4WS

1

2 A + B

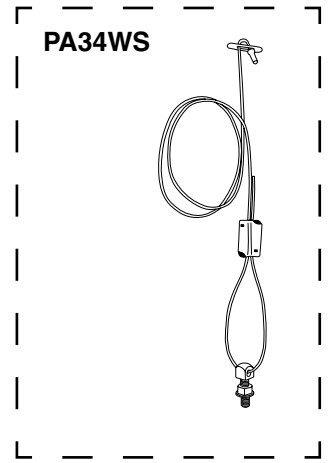

2

4 x 1 



3



4

B

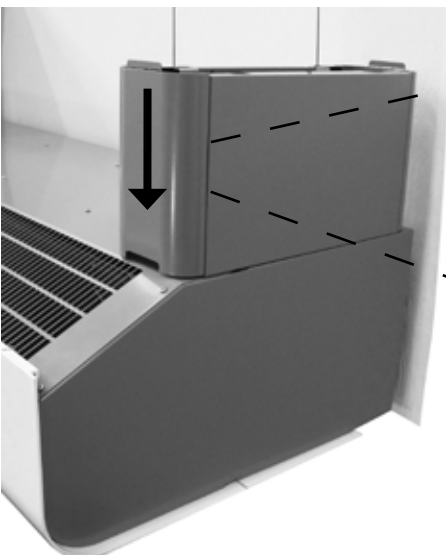

5 2 x C + 2 x D



6

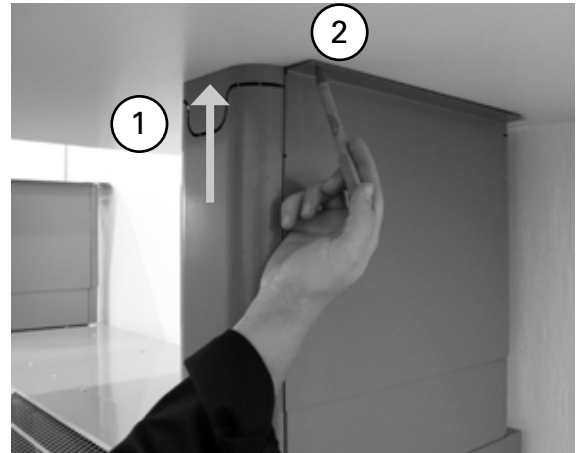

7

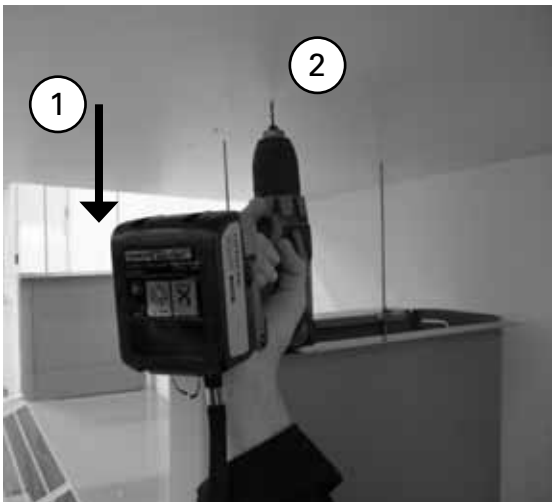

8

4 x K



9

2 4 x J

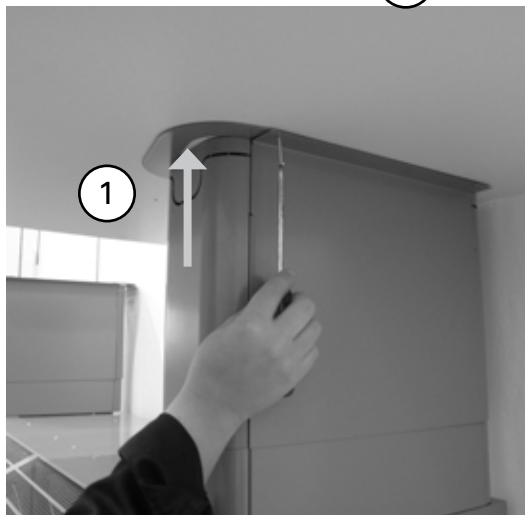

10

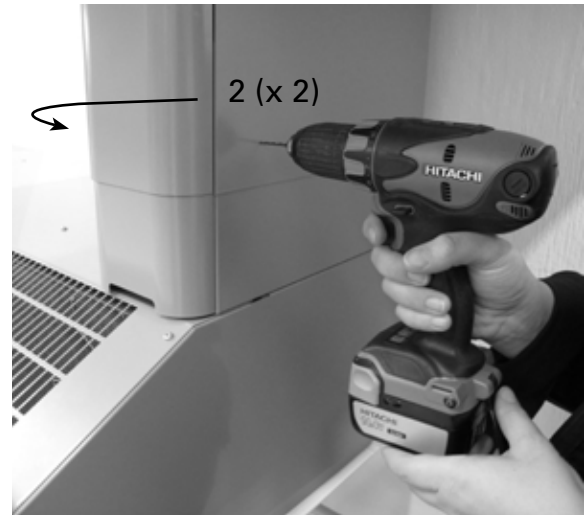

11

2 (x 2) x H 

12



Main office

Frico AB
Box 102
SE-433 22 Partille
Sweden

Tel: +46 31 336 86 00
Fax: +46 31 26 28 25
mailbox@frico.se
www.frico.se

**For latest updated information and information
about your local contact: www.frico.se**