

Uppgiftslämnaren reserverar sig för eventuella fel i produktinformationen eller felaktigt registrerade uppgifter och förbehåller sig rätten att korrigera och/eller komplettera produktinformation utan föregående avisering

1

GRUNDDATA**Varubeskrivning**

Geberit FlowFit pressrördelar i blyfri rödgods

Övriga upplysningar**Klassificeringar**

ETIM ›	-EC003024 - Rördel med 2 anslutningar -EC003099 - Ventilfäste -EC003023 - Rördel med 1 anslutning -EC003025 - Rördel med 3 anslutningar
BK04 ›	
BSAB ›	
UNSPSC ›	

Leverantörsuppgifter**Företagsnamn**

Geberit AB

Organisationsnummer

5566724745

Adress

Folkets Husgatan 1

Hemsida

www.geberit.se

Miljökontaktperson**Namn**

Olle Månsson

Telefon

0734-439089

E-post

olle.mansson@geberit.com

2

HÅLLBARHETSARBETE

Företagets certifiering

- ISO 9000
- ISO 14000

Policys och riktlinjer

3 INNEHÅLLSDEKLARATION

Kemisk produkt	Nej
Omfattas varan av RoHS-direktivet	Nej
Varans vikt	0,187 kg

Vara / Delkomponenter

Koncentrationen har beräknats på hela varan

Ingående material /komponenter	Vikt-% i komponent	CAS-nr (alt legering)	EG-nr (alt legering)	Vikt % i produkt	Kommentar
Gummiblandning baserad på EPDM-polymer		Övrigt, polymer		0,05%	
Polyamides		63428-83-1	Saknas	4,3%	
Rostfritt stål, EN 1.4401, Bedömning på legeringsnivå, 10-13% Ni		12597-68-1	603-108-1	4,3%	
Kiselbrons CuSn4Zn2PS				91,4%	

Del av materialinnehållet som är deklarerat 100,05%

Särskilt farliga ämnen

Varan innehåller INTE några ämnen med särskilt farliga egenskaper (Substances of very high concern, SVHC-ämnena) som finns med på kandidatförteckningen i en koncentration som överstiger 0,1 vikts-%

Utgåva av kandidatförteckningen som har använts
2019-08-22

Nanomaterial

Innehåller produkten tillsatt nanomaterial, som är medvetet tillsatta för att uppnå en viss funktion?: Nej

Tillsatt högflourerade ämnen (PFAS)

Innehåller produkten tillsatt högflourerade ämnen (PFAS), som är aktivt tillsatta för att uppnå en specifik funktion?: Nej

Övrigt

Ämnen är redovisade ned till 2% viktprocent enligt iBVDs redovisningskrav. Eventuell avvikelse från redovisningskraven redovisas nedan

4 RÅVAROR

Återvunnet material

Innehåller varan återvunnet material: Ja

Specifikation av vilka material och andel som utgörs av den totala varans vikt

1. Återvunnet material
2. Andel (%) av totala varans vikt
3. Andel (%) av det återvunna materialet vilket **inte** har passerat konsumentledet
4. Andel (%) av det återvunna materialet vilket har passerat konsumentledet

1	2	3	4
Kiselbrons	21 %		

Träråvara

Träråvara ingår i varan: Nej

5 MILJÖPÅVERKAN

Finns en miljövarudeklaration framtagen enligt EN15804 eller ISO14025 för varan

Ja

Finns annan miljövarudeklaration

Nej

6 DISTRIBUTION

Beskrivning av emballagehantering för distribution av varan

Wellpapp

7

BYGGSCKEDET

Ställer varan särskilda krav vid lagring?	Nej
Ställer varan särskilda krav på omgivande byggvaror?	Nej

8

BRUKSSKEDET

Finns skötselansvisningar/skötselråd?	Nej
Finns en energimärkning enligt energimärkningsdirektivet (2017/1369/EU) för varan?	Nej

9

RIVNING

Kräver varan särskilda åtgärder för skydd av hälsa och miljö vid rivning/demontering?	Nej
---	-----

10

AVFALLSHANTERING

Omfattas den levererade varan av förordningen (2014:1075) om producentansvar för elektriska och elektroniska produkter när den blir avfall?	Nej
Är återanvändning möjlig för hela eller delar av varan?	Nej
Är materialåtervinning möjlig för hela eller delar av varan?	Ja
Återvinning i produktion är möjlig	
Är energiåtervinning möjlig för hela eller delar av varan?	Nej
Har leverantören restriktioner och rekommendationer för återanvändning, material- eller energiåtervinning eller deponering?	Nej
När den levererade varan blir avfall, klassas den då som farligt avfall?	Nej
Avfallskod (EWC) för den levererade varan	170401

RSK-nummer	Eget Artikel-nr	GTIN
225 28 99	620.020.00.1	4025416606093
225 29 00	620.021.00.1	4025416606109
225 29 01	620.022.00.1	4025416606123
225 29 02	620.023.00.1	4025416606130
225 29 03	620.024.00.1	4025416606192
225 29 04	620.025.00.1	4025416606208
225 37 13	620.532.00.1	4025416641186
225 37 14	620.533.00.1	4025416641209
225 37 15	620.534.00.1	4025416641216
225 37 16	620.535.00.1	4025416641223
225 37 17	620.536.00.1	4025416641247
225 37 18	620.540.00.1	4025416641414
225 37 19	620.541.00.1	4025416641438
225 37 20	620.542.00.1	4025416641445
225 37 21	620.550.00.1	4025416641476
225 37 22	620.551.00.1	4025416641483
225 37 23	620.502.00.1	4025416639466
225 37 24	620.503.00.1	4025416639480
225 37 25	620.504.00.1	4025416639503
225 37 26	620.505.00.1	4025416639510
225 37 27	620.506.00.1	4025416639534
225 37 28	620.510.00.1	4025416639541
225 37 29	620.511.00.1	4025416640141
225 37 30	620.512.00.1	4025416640219
225 37 31	620.520.00.1	4025416640226
225 37 32	620.521.00.1	4025416640233
225 37 33	620.522.00.1	4025410627322
225 37 34	620.523.00.1	4025410627353
225 37 35	620.524.00.1	4025410627384
225 37 36	620.525.00.1	4025410627414
225 37 37	620.526.00.1	4025410627445
225 37 38	620.527.00.1	4025410627476
225 37 39	620.528.00.1	4025410627506
225 45 23	620.150.00.1	4025416604921
225 45 24	620.151.00.1	4025416604938
225 45 25	620.152.00.1	4025416604969
225 45 26	620.153.00.1	4025416604983
225 45 27	620.154.00.1	4025416605188
225 45 28	620.155.00.1	4025416605195
225 45 29	620.156.00.1	4025416605218
225 45 30	620.157.00.1	4025416605225
225 45 31	620.162.00.1	4025416605256

225 45 32	620.163.00.1	4025416605287
225 45 33	620.164.00.1	4025416605317
225 45 34	620.165.00.1	4025416605324
225 45 35	620.166.00.1	4025416605348
225 45 36	620.173.00.1	4025416605379
225 45 37	620.174.00.1	4025416605386
225 45 38	620.175.00.1	4025416605409
225 45 39	620.176.00.1	4025416610335
225 45 40	620.177.00.1	4025416188193
225 45 41	620.184.00.1	4025416611769
225 45 42	620.185.00.1	4025416611776
225 60 40	619.617.00.1	4025416602293
225 60 41	619.616.00.1	4025416228776
225 68 41	620.740.00.1	4025416630401
225 68 42	620.741.00.1	4025416630470
225 68 43	620.742.00.1	4025416630531
225 76 76	620.330.00.1	4025416638032
225 76 77	620.331.00.1	4025416638094
225 76 78	620.750.00.1	4025416630586
225 76 79	620.751.00.1	4025416630609
225 76 80	620.760.00.1	4025416630616
225 76 81	620.761.00.1	4025416630869
225 76 82	620.770.00.1	4025416630906
225 76 83	620.771.00.1	4025416630975
225 76 84	620.800.00.1	4025416631057
225 76 85	620.801.00.1	4025416631187
225 76 86	620.802.00.1	4025416631194
225 76 87	620.810.00.1	4025416631217
225 76 88	620.811.00.1	4025416631224
225 76 89	620.821.00.1	4025416631231
225 76 90	620.570.00.1	4025416627128
225 76 91	620.571.00.1	4025416627135
225 76 92	620.572.00.1	4025416627272
225 76 93	620.573.00.1	4025416627289
225 76 94	620.574.00.1	4025416627302
225 76 95	620.575.00.1	4025416627319
225 76 96	620.576.00.1	4025416627333
225 76 97	620.600.00.1	4025416627548
225 76 98	620.601.00.1	4025416627579
225 76 99	620.602.00.1	4025416627586
225 77 00	620.603.00.1	4025416628149
225 77 01	620.604.00.1	4025416628163
225 77 02	620.605.00.1	4025416628170
225 77 03	620.606.00.1	4025416628194
225 77 04	620.613.00.1	4025416628200
225 77 05	620.614.00.1	4025416628224

225 77 06	620.615.00.1	4025416628231
225 77 07	620.580.00.1	4025416627340
225 77 08	620.581.00.1	4025416627371
225 77 09	620.582.00.1	4025416627395
225 77 10	620.583.00.1	4025416627401
225 77 11	620.584.00.1	4025416627425
225 77 12	620.585.00.1	4025416627432
225 77 13	620.586.00.1	4025416627463
225 77 14	620.591.00.1	4025416627470
225 77 15	620.593.00.1	4025416627494
225 77 16	620.594.00.1	4025416627500
225 77 17	620.595.00.1	4025416627517
225 77 18	620.596.00.1	4025416627531
225 77 19	620.720.00.1	4025416629962
225 77 20	620.400.00.1	4025416638445
225 77 21	620.401.00.1	4025416638490
225 77 22	620.402.00.1	4025416638513
225 77 23	620.403.00.1	4025416638520
225 77 24	620.404.00.1	4025416638544
225 77 25	620.405.00.1	4025416638551
225 77 26	620.406.00.1	4025416638612
225 77 27	620.407.00.1	4025416638636
225 77 28	620.410.00.1	4025416638667
225 77 29	620.411.00.1	4025416638674
225 77 30	620.412.00.1	4025416638698
225 77 31	620.413.00.1	4025416638704
225 77 32	620.414.00.1	4025416638728
225 77 33	620.415.00.1	4025416638735
225 77 34	620.416.00.1	4025416638803
225 77 35	620.420.00.1	4025416638827
225 77 36	620.421.00.1	4025416638834
225 77 37	620.424.00.1	4025416638858
225 77 38	620.680.00.1	4025416629580
225 77 39	620.681.00.1	4025416629627
225 77 40	620.690.00.1	4025416629887
225 77 41	620.620.00.1	4025416628262
225 77 42	620.621.00.1	4025416628279
225 77 43	620.622.00.1	4025416628293
225 77 44	620.623.00.1	4025416628309
225 77 45	620.624.00.1	4025416628323
225 77 46	620.625.00.1	4025416628330
225 77 47	620.626.00.1	4025416628354
225 77 48	620.630.00.1	4025416628361
225 77 49	620.631.00.1	4025416628378
225 77 50	620.632.00.1	4025416628392
225 77 51	620.633.00.1	4025416628408

225 77 52	620.634.00.1	4025416628422
225 77 53	620.635.00.1	4025416628446
225 77 54	620.636.00.1	4025416628460
225 77 55	620.640.00.1	4025416628477
225 77 56	620.641.00.1	4025416628484
225 77 57	620.642.00.1	4025416628507
225 77 58	620.643.00.1	4025416628514
225 77 59	620.644.00.1	4025416628538
225 77 60	620.645.00.1	4025416628545
225 77 61	620.646.00.1	4025416628583
225 77 62	620.650.00.1	4025416628590
225 77 63	620.651.00.1	4025416628613
225 77 64	620.652.00.1	4025416628620
225 77 65	620.653.00.1	4025416628644
225 77 66	620.654.00.1	4025416628712
225 77 67	620.655.00.1	4025416628736
225 77 68	620.656.00.1	4025416628743
225 77 69	620.661.00.1	4025416629337
225 77 70	620.662.00.1	4025416629344
225 77 71	620.663.00.1	4025416629498
225 77 72	620.665.00.1	4025416629511
225 77 73	620.671.00.1	4025416629528
225 77 74	620.672.00.1	4025416629542
225 77 75	620.673.00.1	4025416188483
225 77 76	620.675.00.1	4025416629566
225 77 79	620.730.00.1	4025416630005
225 77 80	620.731.00.1	4025416630029
225 77 81	620.732.00.1	4025416630388
225 77 89	620.300.00.1	4025416615187
225 77 90	620.301.00.1	4025416615194
225 77 91	620.302.00.1	4025416615217
225 77 92	620.303.00.1	4025416615224
225 77 93	620.304.00.1	4025416615248
225 77 94	620.305.00.1	4025416613701
225 77 95	620.306.00.1	4025416613725
225 77 96	620.307.00.1	4025416613732
225 77 97	620.310.00.1	4025416613848
225 77 98	620.311.00.1	4025416613855
225 77 99	620.312.00.1	4025416613879
225 78 00	620.313.00.1	4025416614029
225 78 01	620.314.00.1	4025416614036
225 78 02	620.315.00.1	4025416614081
225 78 03	620.316.00.1	4025416614098
225 78 04	620.320.00.1	4025416637974
225 78 05	620.321.00.1	4025416637998
225 78 06	620.322.00.1	4025416638001

225 78 07	620.324.00.1	4025416638025
225 78 08	620.721.00.1	4025416629979
225 78 09	620.722.00.1	4025416629993
225 78 19	620.230.00.1	4025416613411
225 78 20	620.231.00.1	4025416613435
225 78 21	620.232.00.1	4025416613442
225 78 22	620.233.00.1	4025416613466
225 78 23	620.234.00.1	4025416613473
225 78 24	620.235.00.1	4025416613497
225 78 25	620.236.00.1	4025416613503
225 78 26	620.240.00.1	4025416613510
225 78 27	620.241.00.1	4025416613534
225 78 28	620.242.00.1	4025416188339
225 78 37	620.090.00.1	4025416609643
225 78 38	620.091.00.1	4025416609681
225 78 39	620.092.00.1	4025416609698
225 78 40	620.093.00.1	4025416609704
225 78 41	620.094.00.1	4025416615545
225 78 42	620.095.00.1	4025416615606
225 78 43	620.096.00.1	4025416615613
225 78 44	620.097.00.1	4025416188179
225 78 45	620.700.00.1	4025416629894
225 78 46	620.701.00.1	4025416629917
225 78 47	620.710.00.1	4025416629931

Produktdatablad	FlowFit Produktdatablad f iBVD.pdf
Prestandadeklaration	
Säkerhetsblad	
Miljövarudeklaration	epd-geberit-flowfit-metal-fittings-en.pdf
Skötselansvisning	
Övriga bifogade dokument	

ENVIRONMENTAL PRODUCT DECLARATION

IN ACCORDANCE WITH EN 15804 + A1



1 General information

1.1 Note on this document

The original document was written in German. All other language versions are translations of the original document.

1.2 Declaration holder

Geberit International AG
 Schachenstrasse 77
 CH-8645 Jona
 Tel. +41 55 221 6300
 sustainability@geberit.com
 www.geberit.com

Geberit is one of the pioneers when it comes to sustainability in the sanitary industry. Sustainable has formed an integral component of the corporate strategy for around 30 years. The Geberit Group has a group certificate in accordance with ISO 9001 (quality), ISO 14001 (environment) und ISO 45001 (occupational health and safety). Life cycle assessments were produced for key products from an early stage and Ecodesign has been an integral component of the product development process since 2008. You can find current and comprehensive information on sustainability in the current annual report or at www.geberit.com/nachhaltigkeit.

1.3 Declared product

This declaration applies to all Geberit FlowFit metal fittings, which have a base unit made of lead-free gunmetal or silicon bronze (stainless steel fittings are not covered by this environmental product declaration), and no special components such as a copper pipe, mounting plate, insulation box or valves, see chapter "Range and conversion factors", page 4. A piece of Geberit FlowFit elbow tap connector 90° made of lead-free gunmetal (Lead-free gunmetal (CuSn4Zn2PS)) with an outer diameter of d20 mm (art. no. 620.811.00.1) has been applied as a reference article.



1.4 Verification and validity

Programme holder: Geberit International AG
 Declaration number: GEB_EPD_9007206810735115
 Validity: 01/11/2020 to 30/10/2025
 Data calculated by: Quantis, www.quantis-intl.com

Environmental declarations for construction products may not be comparable if they do not comply with the EN 15804. It is only possible to make a limited comparison of life cycle assessment results which are based on different background databases.

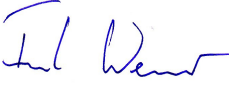
The European standard EN 15804 + A1 is used as the core PCR.	
Independent verification of the declaration and information in accordance with EN ISO 14025:2010	
<input type="checkbox"/> Internal	<input checked="" type="checkbox"/> External
 Dr. Frank Werner	

2 Product

2.1 Description and application purpose

Geberit FlowFit is a supply system consisting of pipes and fittings, which are connected to permanently leakproof pipes by means of lateral pressing.

The system pipes are multilayer pipes made of plastic and aluminium (Geberit system pipe ML) or polybutene pipes (Geberit system pipe PB). The pipes are connected by means of plastic fittings. Metal fittings are used to connect to various connections. A separate environmental product declaration has been created for each of these system elements.

Application purpose:

- for drinking water installations within buildings (Geberit system pipe PB and Geberit system pipe ML)
- for heating and cooling water installations within building structures (Geberit system pipe ML)

2.1.1 Geberit FlowFit metal fittings

The Geberit FlowFit metal pressfitting connects the Geberit system pipes ML and PB to other connections by means of a thread. The pressing procedure permanently deforms the pressing unit (collet and pressing clamp) and pipe and presses them onto the fitting body so that they form a leakproof connection. During the pressing procedure, the pressing indicator is detached and is disposed of as part of the packaging, together with the protective caps, in accordance with the regulations in force in the country of installation.



- | | |
|---|---|
| 1 | Fitting body (lead-free gunmetal) |
| 2 | Corrosion barrier washer (PE-HD) |
| 3 | O-ring (EPDM) |
| 4 | Collet (PA) |
| 5 | Pressing clamp (stainless steel) |
| 6 | Pressing indicator and tool guide rim for pressing jaws (POM) |
| 7 | Protective cap (PE-HD) |

For the composition by raw materials, see chapter "Product composition", page 10

2.2 Range and conversion factors

The reference product for this declaration is the Geberit FlowFit elbow tap connector 90° made of lead-free gunmetal with an outer diameter of d20 mm (art. no. 620.811.00.1). This article was chosen as a reference article because it is the best-selling article and, with an outer diameter of 20 mm, the solution for the best-selling pipe diameter. The life cycle assessment results in chapter 4 can be converted to the other sales articles listed using the net weight (without packaging and protective cap) with the conversion factor in accordance with the following table.

		DN	d [mm]	L [cm]	Net weight [g/ item]	Conversion factor
Geberit FlowFit T-piece with female thread	620.150.00.1	12 / 15 / 12	16	11.9	150	0.80
	620.151.00.1	15	20	11.9	165	0.88
	620.152.00.1	20 / 15 / 20	25	11.9	213	1.14
	620.153.00.1	25 / 15 / 25	32	13	335	1.79
	620.154.00.1	32 / 15 / 32	40	13.4	463	2.48
	620.155.00.1	40 / 15 / 40	50	18.5	1030	5.50
	620.156.00.1	50 / 15 / 50	63	20.5	1725	9.21
	620.157.00.1	20 / 15 / 15	25	11.9	194	1.04
	620.162.00.1	20	25	12.8	226	1.21
	620.163.00.1	25 / 20 / 25	32	13.4	338	1.80
	620.166.00.1	50 / 25 / 50	63	22	1853	9.90
	620.173.00.1	25	32	14.4	393	2.10
	620.174.00.1	32 / 25 / 32	40	14.7	549	2.93
	620.175.00.1	40 / 25 / 40	50	20.2	1142	6.10
	620.176.00.1	50	63	24.6	2362	12.62
	620.177.00.1	65 / 50 / 65	75	21.6	2436	13.01
	620.184.00.1	32	40	15.4	636	3.40
620.185.00.1	40	50	22	1301	6.95	

		DN	d [mm]	L [cm]	Net weight [g/ item]	Conversion factor
Geberit FlowFit adapter with male thread	620.300.00.1	12 / 10	16	6.1	58	0.31
	620.301.00.1	15 / 10	20	6.1	69	0.37
	620.302.00.1	20 / 15	25	6.4	100	0.54
	620.303.00.1	25	32	7.5	212	1.13
	620.304.00.1	32 / 25	40	7.4	321	1.71
	620.305.00.1	40	50	10	691	3.69
	620.306.00.1	50	63	11	1125	6.01
	620.307.00.1	65	75	11.4	1491	7.96
	620.310.00.1	12 / 15	16	6.1	71	0.38
	620.311.00.1	15	20	6.4	85	0.46
	620.312.00.1	20	25	6.8	127	0.68
	620.313.00.1	25 / 32	32	7.2	259	1.38
	620.314.00.1	32	40	7.4	324	1.73
	620.315.00.1	40 / 50	50	10.4	726	3.88
	620.316.00.1	50 / 65	63	11.3	1224	6.54
	620.320.00.1	12 / 20	16	6.5	96	0.51
	620.321.00.1	15 / 20	20	6.5	104	0.56
	620.322.00.1	20 / 25	25	6.6	162	0.87
	620.324.00.1	32 / 40	40	7.3	331	1.77
Geberit FlowFit adapter with female thread	620.400.00.1	12 / 10	16	5.1	53	0.28
	620.401.00.1	15 / 10	20	5.3	65	0.35
	620.402.00.1	20	25	5.7	112	0.60
	620.403.00.1	25	32	6.4	200	1.07
	620.404.00.1	32 / 25	40	6.4	317	1.69
	620.405.00.1	40	50	9.3	674	3.60
	620.406.00.1	50	63	10.2	1148	6.13
	620.407.00.1	65	75	10.7	1345	7.18
	620.410.00.1	12 / 15	16	5.6	78	0.42
	620.411.00.1	15	20	5.5	82	0.44
	620.412.00.1	20 / 25	25	6.1	172	0.92
	620.413.00.1	25 / 32	32	6.7	228	1.22
	620.414.00.1	32	40	6.7	251	1.34
	620.415.00.1	40 / 50	50	9.7	685	3.66
	620.416.00.1	50 / 65	63	10.7	1117	5.97
	620.420.00.1	12 / 20	16	5.8	93	0.50
	620.421.00.1	15 / 20	20	5.8	103	0.55
620.424.00.1	32 / 40	40	6.7	297	1.59	
Geberit FlowFit tap connector, straight, with male thread	619.471.22.1	15	20/R 1/2"	—	85	0.46
	619.481.22.1	15	20/R 3/4"	—	104	0.56
	619.472.22.1	20	25/R 1/2"	—	100	0.54
	619.482.22.1	20	25/R 3/4"	—	127	0.68

2 Product

		DN	d [mm]	L [cm]	Net weight [g/ item]	Conversion factor
Geberit FlowFit tap connector, straight, with union nut	619.490.22.1	12	16	6.4	74	0.40
	619.491.22.1	15	20	6.4	93	0.50
	619.492.22.1	20	25	6.5	126	0.67
Geberit FlowFit bend adapter 90° with male thread	620.502.00.1	20	25	6	145	0.77
	620.503.00.1	25	32	6.8	225	1.20
	620.504.00.1	32	40	7.3	365	1.95
	620.505.00.1	40	50	10.4	786	4.20
	620.506.00.1	50	63	11.7	1353	7.23
	620.510.00.1	12 / 15	16	5.7	82	0.44
	620.511.00.1	15	20	6.1	111	0.59
	620.512.00.1	20 / 25	25	6.3	167	0.89
	620.520.00.1	12 / 20	16	6	115	0.61
	620.521.00.1	15 / 20	20	6	114	0.61
Geberit FlowFit bend adapter 90° with female thread	620.532.00.1	20	25	6.5	186	0.99
	620.533.00.1	25	32	7.4	281	1.50
	620.534.00.1	32	40	8.1	426	2.27
	620.535.00.1	40	50	11.2	897	4.79
	620.536.00.1	50	63	12.8	1406	7.51
	620.540.00.1	12 / 15	16	6.1	110	0.59
	620.541.00.1	15	20	6.1	122	0.65
	620.542.00.1	20 / 25	25	6.9	227	1.21
	620.550.00.1	12 / 20	16	6.3	163	0.87
	620.551.00.1	15 / 20	20	6.5	156	0.84
Geberit FlowFit adapter to Geberit Mepla	620.090.00.1	12	16	7.8	62	0.33
	620.091.00.1	15	20	7.8	82	0.44
	620.092.00.1	20	25	7.8	95	0.51
	620.093.00.1	25	32	8.8	197	1.05
	620.094.00.1	32	40	8.8	267	1.43
	620.095.00.1	40	50	14	810	4.33
	620.096.00.1	50	63	15	1371	7.32
	620.097.00.1	65	75	15	1646	8.79
Geberit FlowFit adapter to Geberit Mapress	620.230.00.1	12 / 10	16	6.8	47	0.25
	620.240.00.1	12	16	6.9	52	0.28
	620.231.00.1	15 / 12	20	6.9	63	0.34
	620.241.00.1	15	20	6.9	69	0.37
	620.242.00.1	15 / 20	20	7	77	0.41
	620.232.00.1	20	25	7	91	0.49
	620.233.00.1	25	32	7.7	147	0.78
	620.234.00.1	32	40	8	213	1.14
	620.235.00.1	40	50	12.8	580	3.10
	620.236.00.1	50	63	13.8	952	5.09

		DN	d [mm]	L [cm]	Net weight [g/ item]	Conversion factor
Geberit FlowFit adapter with union nut	620.620.00.1	12	16	6.2	54	0.29
	620.630.00.1	12 / 15	16	6.4	74	0.40
	620.640.00.1	12 / 20	16	5.9	83	0.45
	620.650.00.1	12 / 25	16	6.2	132	0.70
	620.660.00.1	12	16	—	152	0.81
	620.621.00.1	15 / 12	20	6.2	66	0.35
	620.631.00.1	15	20	6.4	84	0.45
	620.641.00.1	15 / 20	20	6.5	104	0.56
	620.651.00.1	15 / 25	20	6.3	146	0.78
	620.672.00.1	15 / 30	20	6.4	159	0.85
	620.661.00.1	15 / 32	20	6.6	198	1.06
	620.671.00.1	15 / 40	20	6.2	286	1.53
	620.622.00.1	20 / 15	25	6.4	104	0.55
	620.632.00.1	20	25	6.5	126	0.67
	620.642.00.1	20 / 25	25	7.3	191	1.02
	620.652.00.1	20 / 32	25	6.8	216	1.15
	620.662.00.1	20 / 40	25	7.1	323	1.72
	620.673.00.1	20 / 50	25	6.3	426	2.27
	620.623.00.1	25 / 20	32	7	165	0.88
	620.633.00.1	25	32	7.8	231	1.23
	620.643.00.1	25 / 32	32	7.4	269	1.44
	620.653.00.1	25 / 40	32	7.6	362	1.94
	620.663.00.1	25 / 50	32	7.5	571	3.05
	620.624.00.1	32	40	7.9	319	1.70
	620.634.00.1	32	40	8	422	2.25
	620.644.00.1	32 / 50	40	7.8	828	4.42
	620.654.00.1	32 / 65	40	7.7	729	3.89
	620.625.00.1	40	50	10.6	700	3.74
	620.635.00.1	40	50	11.5	890	4.76
	620.645.00.1	40 / 50	50	11	925	4.94
	620.655.00.1	40 / 50	50	10.8	1043	5.57
	620.665.00.1	40 / 50	50	10.9	1008	5.38
	620.675.00.1	40 / 65	50	10.7	1266	6.76
	620.626.00.1	50 / 50	63	11.5	1111	5.94
	620.636.00.1	50 / 50	63	11.6	1221	6.52
	620.646.00.1	50 / 65	63	11.8	1622	8.67
	620.656.00.1	50 / 65	63	11.5	1581	8.45
	620.560.00.1	12	16	5.4	132	0.71
	620.561.00.1	15	20	5.4	138	0.74
	620.562.00.1	20	25	5.5	256	1.37

2 Product

		DN	d [mm]	L [cm]	Net weight [g/ item]	Conversion factor
Geberit FlowFit screw connection	620.570.00.1	12	16	11.5	137	0.73
	620.571.00.1	15	20	11.7	156	0.83
	620.572.00.1	20	25	12.1	228	1.22
	620.573.00.1	25	32	13.9	373	1.99
	620.574.00.1	32	40	13.9	519	2.77
	620.575.00.1	40	50	19.1	1172	6.26
	620.576.00.1	50	63	20.5	1960	10.47
Geberit FlowFit adapter union with male thread	620.580.00.1	12 / 15	16	8.7	125	0.67
	620.581.00.1	15	20	9.3	143	0.76
	620.591.00.1	15 / 20	20	9.4	143	0.76
	620.582.00.1	20	25	10.2	250	1.33
	620.583.00.1	25	32	10.5	385	2.06
	620.593.00.1	25 / 32	32	10.8	385	2.06
	620.584.00.1	32	40	11.3	584	3.12
	620.594.00.1	32 / 40	40	11.3	596	3.18
	620.585.00.1	40	50	14.9	1250	6.67
	620.595.00.1	40 / 50	50	14.9	1420	7.59
	620.586.00.1	50	63	15.3	2262	12.08
	620.596.00.1	50 / 65	63	15.5	2262	12.08
Geberit FlowFit adapter union with female thread	620.600.00.1	12 / 15	16	7.9	125	0.67
	620.601.00.1	15	20	8.5	143	0.76
	620.602.00.1	20	25	9.2	250	1.33
	620.603.00.1	25	32	9.4	385	2.06
	620.613.00.1	25 / 32	32	10.6	385	2.06
	620.604.00.1	32	40	10.9	585	3.12
	620.614.00.1	32	40	11.2	596	3.18
	620.605.00.1	40	50	13.8	1081	5.77
	620.615.00.1	40 / 50	50	14.9	1521	8.12
	620.606.00.1	50	63	13.3	2370	12.66
Geberit FlowFit adapter union with clamping ring	620.680.00.1	12 / 10	16	5.8	128	0.68
	620.690.00.1	12	16	5.8	117	0.62
	620.681.00.1	15 / 12	20	6	141	0.76
Geberit FlowFit elbow adapter with clamping ring union	620.700.00.1	12 / 10	16	5.5	157	0.84
	620.710.00.1	12	16	5.5	141	0.75
	620.701.00.1	15 / 12	20	5.7	156	0.83
Geberit FlowFit adapter with screw connection to PEX pipes	620.730.00.1	12	16	7.8	167	0.89
	620.731.00.1	15	20	7.8	173	0.92
	620.732.00.1	20	25	8	269	1.44
Geberit FlowFit pipe end plug	620.740.00.1	12	16	3.9	34	0.18
	620.741.00.1	15	20	3.9	46	0.24
	620.742.00.1	20	25	3.9	66	0.35
Geberit connection nipple for manifold	620.330.00.1	12 / 20	16	6.1	70	0.37
	620.331.00.1	15 / 20	20	6.5	90	0.48

		DN	d [mm]	L [cm]	Net weight [g/ item]	Conversion factor
Geberit FlowFit flange	619.616.00.1	65	75	11.3	1798	9.61
	619.617.00.1	65	75	11.3	1828	9.76
Geberit FlowFit elbow tap connector 90°	620.750.00.1	12	16	3.6	141	0.76
	620.751.00.1	15	20	3.6	141	0.75
	620.760.00.1	12	16	3.6	154	0.82
	620.761.00.1	15	20	3.6	151	0.81
	620.810.00.1	12	16	5.2	174	0.93
	620.811.00.1	15	20	5.2	187	1.00
	620.821.00.1	15	20	5.2	231	1.23
	620.802.00.1	20	25	5.2	213	1.14
	620.770.00.1	12	16	7.8	241	1.29
	620.771.00.1	15	20	7.8	257	1.37
	620.800.00.1	12	16	5.2	185	0.99
	620.801.00.1	15	20	5.2	193	1.03
Geberit FlowFit double elbow tap connector 90°	620.830.00.1	12 / 15 / 12	16	5.2	316	1.69
	620.831.00.1	12 / 15 / 15	16	5.2	331	1.77
	620.832.00.1	15 / 15 / 20	20	5.2	332	1.77
	620.841.00.1	15 / 15 / 12	20	5.2	364	1.94
	620.842.00.1	20 / 15 / 15	25	5.2	332	1.77
	620.851.00.1	15	20	5.2	352	1.88
	620.852.00.1	20 / 15 / 20	25	5.2	326	1.74
Geberit FlowFit corner elbow connector 90°	620.881.00.1	15	20	3.7	256	1.37
	620.921.00.1	15	20	5.3	299	1.60
Geberit FlowFit elbow tap connector 90° for concealed cistern	620.790.00.1	12	16	6.8	145	0.78
	620.791.00.1	15	20	7	166	0.89
	620.890.00.1	12	16	6.8	230	1.23
	620.891.00.1	15	20	6.8	243	1.30
Geberit FlowFit T-elbow tap connector 90°	620.951.00.1	15	20	3.6	333	1.78
	620.981.00.1	15	20	13.4	374	2.00
Geberit FlowFit long coupling	620.020.00.1	12	16	20	294	1.57
	620.021.00.1	15	20	20	385	2.06
	620.022.00.1	20	25	20	494	2.64
	620.023.00.1	25	32	22.2	859	4.59
	620.024.00.1	32	40	23.5	1390	7.43
	620.025.00.1	40	50	34	2477	13.23

3 Life cycle assessment – calculation criteria

3.1 System boundaries

This environmental product declaration is a Cradle-to-gate-with-options declaration including transport and waste processing during the disposal phase. The use and demolition are not considered.

Product			Construction process		Use	End-of-life			
Raw material	Transport to the manufacturer	Manufacturing	Distribution	Installation within the building		Demolition	Transport to waste processing	Reuse, recovery, recycling	Disposal
A1	A2	A3	A4	A5	B1-B7	C1	C2	C3	C4
x	x	x	x	x	–	–	x	x	x

x Considered/relevant

– Not considered/not relevant

3.2 Product composition

The reference article consists of the following raw materials:

Raw material	Quantity [g]
Plastics	8
Elastomers	0,1
Lead-free gunmetal	171
Stainless steel	8
Total	187
Recycled content (post-consumer)	21 %

The packaging includes: 7 g of cardboard and 4 g of plastic (including protective caps).

The articles shown in this environmental product declaration do not contain PVC or halogen compounds.

List of substances contained in the product, which are included in the "Candidate List of Substances of Very High Concern for Authorisation" if the content exceeds the limits for their registration by the European Chemicals Agency:

- none

3.3 Assumptions and background information

(A1) For the raw material supply, the entire raw and recycled material input was modelled using corresponding data, including the losses of 1–6 % relating to material and production. Secondary materials comprise those environmental influences that arise from the collection of waste and from recycling. The following recycled content was recorded: 22 % for stainless steel, brass and gunmetal and 10 % for cardboard.

(A2) For transportation from suppliers in Europe and Asia to Geberit, standard transport distances were assumed for each country and load factors contained in the background data were used. Class Euro 5 diesel lorries are used as the means of transport within Europe. Intercontinental transportation consists of freighters and subsequent local distribution by lorry.

(A3) Products are manufactured in one or more Geberit factories within Europe, which are all certified in accordance with ISO 9001, 14001 and 45001. A current ISO certificate can be downloaded online. All suppliers sign the Geberit suppliers' code of conduct and undergo a detailed selection and inspection procedure.

The electricity consumption plays an important role in in-house production. Average values from the respective factories and a country-specific combination of power sources are assumed.

The production and provision of packaging materials and means of production (technical lubricants) were also modelled in phase A3. The consumption of additional auxiliary materials and water is negligible. Production waste is taken into account. However, the scrap flows associated with the production flows are not listed in A3 as they are handled with a conservative allocation factor of 0.

Background data from the ecoinvent database was used for the third-party components.

(A4) Transportation from Geberit to customers within Europe is done by logistics partners through the modern, efficient central warehouse in Pfullendorf (DE), which is certified in accordance with ISO 9001, 14001 and 45001. Class Euro 5 and 6 lorries are mainly used for the transport. Distribution in countries outside Europe is mainly done by means of freighters together with lorries to distribute the products locally. In the main market in Europe, the average transport distance is 650 km and the loading weight is 8 t/lorry.

(A5) The installation is easy and needs no additional auxiliary materials and practically no energy. The packaging waste generated can be completely reused or converted into energy in the respective country depending on the disposal infrastructure.

100 % of cardboard and paper is recycled. The energy is recovered from plastic in the packaging in an incineration plant. The assumed energy content per kg is 43.9 MJ for plastics, 30.2 MJ for elastomers and 16.9 MJ for cardboard and paper. The energy efficiency is 42 % for heat and 14 % for electricity.

(B1-B7) No further statements are made concerning the use phase.

(C1-C4) Waste that is reused is removed from the product system without causing any environmental impact from the first life cycle. No credits are accounted for cases where production of such waste was avoided. With respect to disposal, it has been assumed that all waste is collected once it has been taken from the building site and is sorted appropriately. 100 % of all metal parts are recycled. The plastic parts are incinerated (with the assumptions already described). A transport distance of 20 km is assumed for both disposal options.

3.4 Data basis and data quality

This environmental product declaration is based on a comprehensive life cycle assessment according to ISO 14044:2006. A detailed background report, which meets the requirements of EN 15804, is used for verification. Inventory data is based predominantly on data that was provided by Geberit International AG in 2020. ecoinvent data (version 3.4, 2017, www.ecoinvent.org) and the system model "cut-off by classification" were used for all further data. The quality of the data can therefore be considered to be good.

4 Life cycle assessment – results

The following tables contain the results based on a piece of the declared product.

4.1 Environmental impacts

	Unit	A1	A2	A3	A4	A5	C1	C2	C3	C4
Global warming (GWP)	kg CO ₂ -eq	8.61E-01	1.44E-02	3.07E-01	1.11E-02	1.28E-03	0	3.31E-04	3.00E-02	0
Ozone depletion (ODP)	kg CFC-11-eq	4.09E-08	2.57E-09	1.66E-08	2.19E-09	1.31E-12	0	6.51E-11	5.78E-11	0
Photochemical ozone creation (POCP)	kg C ₂ H ₄ -eq	1.86E-03	5.67E-06	3.35E-04	1.77E-06	1.90E-09	0	5.27E-08	8.40E-08	0
Acidification (AP)	kg SO ₂ -eq	4.73E-02	1.62E-04	8.10E-03	3.59E-05	1.18E-07	0	1.07E-06	4.11E-06	0
Eutrophication (EP)	kg PO ₄ ³⁻ -eq	3.30E-02	1.97E-05	5.54E-03	7.93E-06	1.02E-07	0	2.36E-07	3.06E-06	0
Depletion of abiotic resources (ADP), fossil fuels	MJ	9.22E+00	2.25E-01	3.39E+00	1.86E-01	1.54E-04	0	5.51E-03	5.60E-03	0
Depletion of abiotic resources (ADP), elements	kg Sb-eq	5.70E-04	1.66E-08	3.59E-05	2.17E-08	1.51E-11	0	6.45E-10	6.06E-10	0

A1 Raw material

A2 Transport to the manufacturer

A3 Manufacturing

A4 Distribution

A5 Installation

C2 Transport to waste processing

C3 Reuse, recovery, recycling

C4 Disposal

4.2 Resource use

	Unit	A1	A2	A3	A4	A5	C1	C2	C3	C4
Use of primary energy, renewable, w/o raw material use	MJ	1.69E+00	4.40E-03	4.76E-01	3.16E-03	2.78E-06	0	9.38E-05	1.56E-04	0
Use of primary energy, renewable, raw material use	MJ	0	0	1.10E-01	0	0	0	0	0	0
Use of primary energy, renewable, total	MJ	1.69E+00	4.40E-03	5.86E-01	3.16E-03	2.78E-06	0	9.38E-05	1.56E-04	0
Use of primary energy, non-renewable, w/o raw material use	MJ	9.69E+00	2.33E-01	3.68E+00	1.91E-01	1.57E-04	0	5.67E-03	5.76E-03	0
Use of primary energy, non-renewable, raw material use	MJ	3.59E-01	0	1.78E-01	0	0	0	0	0	0
Use of primary energy, non-renewable, total	MJ	1.00E+01	2.33E-01	3.86E+00	1.91E-01	1.57E-04	0	5.67E-03	5.76E-03	0
Use of secondary materials	kg	3.95E-02	0	0	0	0	0	0	0	0
Use of renewable secondary fuels	MJ	0	0	0	0	0	0	0	0	0
Use of non-renewable secondary fuels	MJ	0	0	0	0	0	0	0	0	0
Use of net fresh water	m ³	2.19E-01	4.09E-06	4.45E-02	3.34E-04	1.59E-06	0	9,92E-06	1.78E-04	0

4.3 Output flows and waste

	Unit	A1	A2	A3	A4	A5	C1	C2	C3	C4
Hazardous waste	kg	1.72E-04	1.19E-07	6.20E-06	9.14E-08	1.32E-09	0	2.71E-09	2.39E-08	0
Radioactive waste	kg	2.22E-05	1.49E-06	1.00E-05	1.27E-06	2.94E-10	0	3.76E-08	1.31E-08	0
Non-hazardous waste	kg	2.65E-01	1.11E-02	7.99E-02	1.57E-02	2.11E-05	0	4.65E-04	6.60E-04	0
Components for re-use	kg	0	0	0	0	0	0	0	0	0
Materials for recycling	kg	0	0	0	0	6.48E-03	0	0	1.79E-01	0
Materials for energy recovery	kg	0	0	0	0	0	0	0	0	0
Exported energy – electricity	MJ	0	0	0	0	2.75E-03	0	0	6.97E-02	0
Exported energy – heat	MJ	0	0	0	0	8.26E-03	0	0	2.09E-01	0



Geberit International AG
Schachenstrasse 77, CH-8645 Jona
documentation@geberit.com
www.geberit.com



GEBERIT FLOWFIT PRODUKTDATBLAD

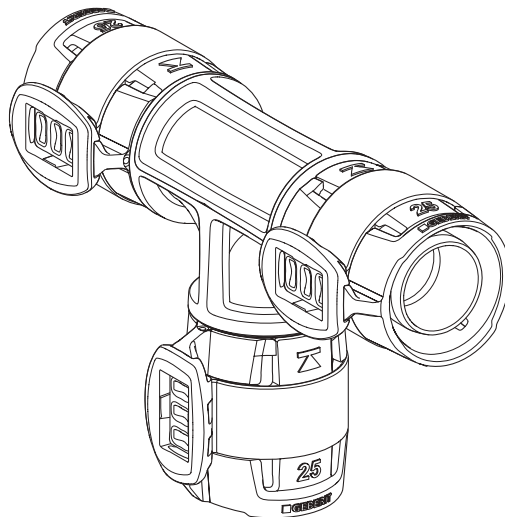

4 SORTIMENT

4.1 GEBERIT SYSTEMRÖR ML, RAKLÄNGD

Geberit systemrör ML, raklängd

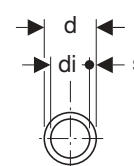
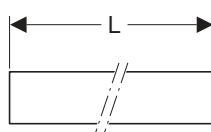
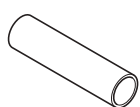

Artikelnr	RSK nr.	DN	d [mm]	di [mm]	s [mm]	L (m)
619.010.00.1	2005477	12	16	12	2	3
619.011.00.1	2005479	15	20	16	2	3
619.012.00.1	2005480	20	25	20	2,5	3
619.013.00.1	2005481	25	32	26,4	2,8	3
619.014.00.1	2005482	32	40	34	3	3
619.015.00.1	2005483	40	50	42,4	3,8	3
619.016.00.1	2005484	50	63	55	4	3
619.020.00.1	2005485	12	16	12	2	5
619.021.00.1	2005487	15	20	16	2	5
619.022.00.1	2005488	20	25	20	2,5	5
619.023.00.1	2005489	25	32	26,4	2,8	5
619.024.00.1	2005490	32	40	34	3	5
619.025.00.1	2005491	40	50	42,4	3,8	5
619.026.00.1	2005492	50	63	55	4	5
619.027.00.1	2005493	65	75	65,8	4,6	5

4.2 GEBERIT FLOWFIT KOPPLINGAR

Geberit FlowFit koppling

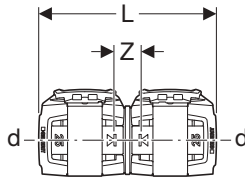
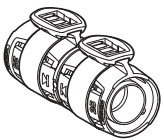

Artikelnr	RSK nr.	DN	d [mm]	L [cm]	Z [cm]
620.010.00.1	2252891	12	16	7,7	1,2
620.011.00.1	2252892	15	20	7,7	1,2
620.012.00.1	2252893	20	25	7,7	1,2
620.013.00.1	2252894	25	32	8,7	1,5
620.014.00.1	2252895	32	40	8,7	1,5
620.015.00.1	2252896	40	50	14,1	2,2
620.016.00.1	2252897	50	63	15,1	2,4
620.017.00.1	2252898	65	75	15,1	2,4

Geberit FlowFit lång koppling

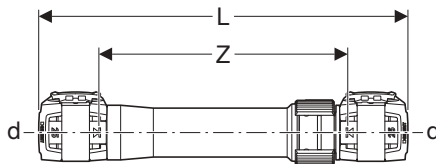
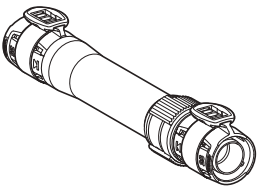

Artikelnr	RSK nr.	DN	d [mm]	L [cm]	Z [cm]
620.020.00.1	2252899	12	16	20	13,5
620.021.00.1	2252900	15	20	20	13,5
620.022.00.1	2252901	20	25	20	13,5
620.023.00.1	2252902	25	32	22,2	15
620.024.00.1	2252903	32	40	23,5	16,3
620.025.00.1	2252904	40	50	34	22

4.3 GEBERIT FLOWFIT REDUCERINGAR

Geberit FlowFit reducering

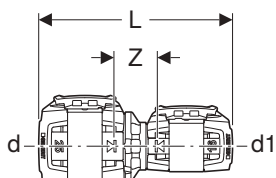
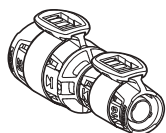

Artikelnr	RSK nr.	DN	d [mm]	d1 [mm]	L [cm]	Z [cm]
620.031.00.1	2252905	15/12	20	16	8,4	1,9
620.032.00.1	2252906	20/12	25	16	8,4	1,9
620.042.00.1	2252912	20/15	25	20	8,4	1,9
620.033.00.1	2252907	25/15	32	20	8,9	2
620.043.00.1	2252913	25/20	32	25	8,9	2
620.034.00.1	2252908	32/15	40	20	9,2	2,3
620.044.00.1	2252914	32/20	40	25	8,9	2
620.054.00.1	2252918	32/25	40	32	9,4	2,1
620.035.00.1	2252909	40/25	50	32	12,2	2,7
620.045.00.1	2252915	40/32	50	40	12,2	2,7
620.036.00.1	2252910	50/32	63	40	12,9	3
620.046.00.1	2252916	50/40	63	50	15,7	3,4
620.037.00.1	2252911	65/32	75	40	13,6	3,7
620.047.00.1	2252917	65/40	75	50	15,7	3,4
620.057.00.1	2252919	65/50	75	63	16,2	3,5

4.4 GEBERIT FLOWFIT BÖJAR

Geberit FlowFit böj

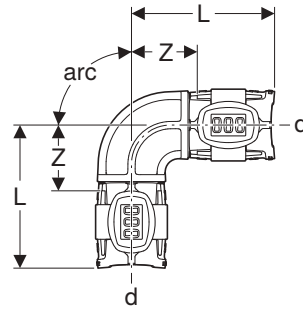
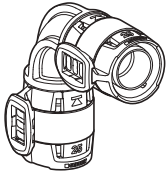

Artikelnr	RSK nr.	DN	d [mm]	L [cm]	Z [cm]
620.062.00.1	2253699	20	25	5,2	1,9
620.063.00.1	2253700	25	32	5,9	2,3
620.064.00.1	2253701	32	40	5,9	2,5
620.065.00.1	2253702	40	50	9	3
620.066.00.1	2253703	50	63	9,9	3,5
620.067.00.1	2253704	65	75	9,9	3,5
620.070.00.1	2253705	12	16	5,8	2,5
620.071.00.1	2253706	15	20	6	2,7
620.072.00.1	2253707	20	25	6,2	3
620.073.00.1	2253708	25	32	7	3,4
620.074.00.1	2253709	32	40	7,5	3,9
620.075.00.1	2253710	40	50	11,5	5,6
620.076.00.1	2253711	50	63	12,5	6,1
620.077.00.1	2253712	65	75	13	6,7

4.5 GEBERIT FLOWFIT T-RÖR

Geberit FlowFit T-rör liksidigt

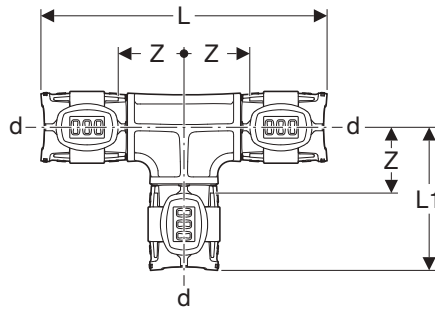
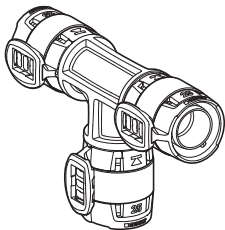

Artikelnr	RSK nr.	DN	d [mm]	L [cm]	L1 [cm]	Z [cm]
620.080.00.1	2254515	12	16	11,5	5,8	2,5
620.081.00.1	2254516	15	20	11,9	6	2,7
620.082.00.1	2254517	20	25	12,4	6,2	2,9
620.083.00.1	2254518	25	32	14	7	3,4
620.084.00.1	2254519	32	40	15	7,5	3,9
620.085.00.1	2254520	40	50	23	11,5	5,6
620.086.00.1	2254521	50	63	24,9	12,5	6,1
620.087.00.1	2254522	65	75	26,1	13,1	6,7

Geberit FlowFit T-rör reducerat

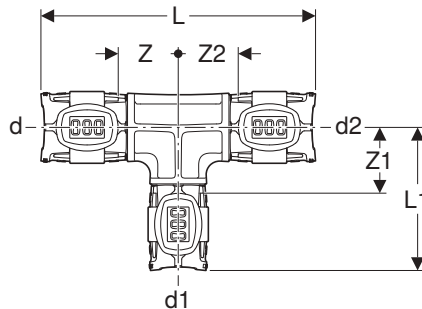
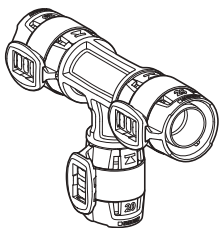

Artikelnr	RSK nr.	DN	d [mm]	d1 [mm]	d2 [mm]	L [cm]	L1 [cm]	Z [cm]	Z1 [cm]	Z2 [cm]
620.101.00.1	2254543	15 / 12 / 12	20	16	16	11,5	6	2,4	2,7	2,5
620.102.00.1	2254544	20 / 15 / 15	25	20	20	11,9	6,2	2,7	2,9	2,7
620.103.00.1	2254545	25 / 20 / 20	32	25	25	12,7	6,7	2,9	3,4	2,9
620.104.00.1	2254546	32 / 15 / 32	40	20	40	12,7	7,2	2,8	3,9	2,8
620.105.00.1	2254547	40 / 32 / 32	50	40	40	17,9	8,7	4	5	4,4
620.106.00.1	2254548	50 / 20 / 50	63	25	63	19,4	9	3,4	5,7	3,4
620.107.00.1	2254549	65 / 20 / 65	75	25	75	19,4	9,6	3,4	6,3	3,4
620.111.00.1	2254550	15 / 12 / 15	20	16	20	11,5	6	2,5	2,7	2,5
620.112.00.1	2254551	20 / 12 / 20	25	16	25	11,5	6,2	2,5	2,9	2,5
620.113.00.1	2254552	25 / 12 / 25	32	16	32	12	6,7	2,4	3,4	2,4
620.114.00.1	2254553	32 / 20 / 32	40	25	40	13,2	7,1	3	3,8	3
620.115.00.1	2254554	40 / 20 / 40	50	25	50	18,9	8,3	3,5	5	3,5

Artikelnr	RSK nr.	DN	d [mm]	d1 [mm]	d2 [mm]	L [cm]	L1 [cm]	Z [cm]	Z1 [cm]	Z2 [cm]
620.116.00.1	2254555	50 / 25 / 50	63	32	63	20,4	9,3	3,9	5,7	3,9
620.117.00.1	2254556	65 / 25 / 65	75	32	75	20,4	9,9	3,9	6,3	3,9
620.121.00.1	2254557	12 / 15 / 12	16	20	16	11,9	5,8	2,7	2,5	2,7
620.122.00.1	2254558	20 / 15 / 20	25	20	25	11,9	6,2	2,7	2,9	2,7
620.123.00.1	2254559	25 / 15 / 20	32	20	25	12,2	6,7	2,7	3,4	2,7
620.124.00.1	2254560	32 / 25 / 32	40	32	40	14,2	7,4	3,5	3,8	3,5
620.125.00.1	2254561	40 / 25 / 40	50	32	50	19,9	8,6	4	5	4
620.126.00.1	2254562	50 / 32 / 50	63	40	63	21,2	9,4	4,3	5,8	4,3
620.127.00.1	2254563	65 / 32 / 65	75	40	75	21,2	10	4,3	6,4	4,3
620.131.00.1	2254564	15 / 15 / 12	20	20	16	11,9	6	2,7	2,7	2,7
620.132.00.1	2254565	15 / 20 / 15	20	25	20	12,4	6	2,9	2,7	2,9
620.133.00.1	2254566	25 / 15 / 25	32	20	32	12,5	6,7	2,7	3,4	2,7
620.135.00.1	2254567	40 / 32 / 40	50	40	50	20,7	8,7	4,4	5	4,4
620.136.00.1	2254568	50 / 40 / 50	63	50	63	23,5	12,2	5,4	6,3	5,4
620.137.00.1	2254569	65 / 40 / 65	75	50	75	23,5	12,8	5,4	6,9	5,4
620.142.00.1	2254570	20 / 20 / 15	25	25	20	12,4	6,2	2,9	2,9	2,9
620.143.00.1	2254571	25 / 20 / 25	32	25	32	13	6,7	2,9	3,4	2,9
620.147.00.1	2254572	65 / 50 / 65	75	63	75	24,9	13	6,1	6,7	6,1

2 / 2

Geberit FlowFit T-rör med invändig gänga

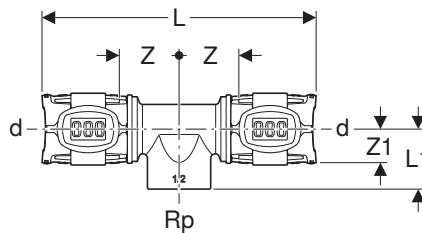
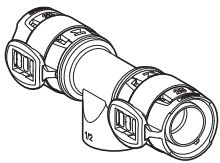

Artikelnr	RSK nr.	DN	d [mm]	Rp ["]	d1 [mm]	L [cm]	L1 [cm]	Z [cm]	Z1 [cm]
620.150.00.1	2254523	12 / 15 / 12	16	1/2	16	11,9	2,4	2,7	1,1
620.157.00.1	2254530	20 / 15 / 15	25	1/2	20	11,9	2,6	2,7	1,3
620.151.00.1	2254524	15	20	1/2	20	11,9	2,4	2,7	1,1
620.152.00.1	2254525	20 / 15 / 20	25	1/2	25	11,9	2,6	2,7	1,3
620.162.00.1	2254531	20	25	3/4	25	12,8	2,8	3,1	1,5
620.163.00.1	2254532	25 / 20 / 25	32	3/4	32	13,4	3,1	3,1	1,7
620.173.00.1	2254536	25	32	1	32	14,4	3,1	3,6	1,6
620.153.00.1	2254526	25 / 15 / 25	32	1/2	32	13	3,1	2,9	1,3
620.164.00.1	2254533	32 / 20 / 32	40	3/4	40	14,7	3,5	3,8	2,1
620.154.00.1	2254527	32 / 15 / 32	40	1/2	40	13,4	3,4	3,1	1,9
620.184.00.1	2254541	32	40	1 1/4	40	15,4	4,4	4,1	2,3
620.174.00.1	2254537	32 / 25 / 32	40	1	40	14,7	4,2	3,8	2,3
620.175.00.1	2254538	40 / 25 / 40	50	1	50	20,2	4,6	4,2	2,5
620.185.00.1	2254542	40	50	1 1/2	50	22	4,6	5,1	2,3
620.165.00.1	2254534	40 / 20 / 40	50	3/4	50	20,2	4	4,2	2,6
620.155.00.1	2254528	40 / 15 / 40	50	1/2	50	18,5	4,1	3,3	2,4
620.166.00.1	2254535	50 / 25 / 50	63	1	63	22	5,1	4,7	3,2
620.176.00.1	2254539	50	63	2	63	24,6	6,6	6	4
620.156.00.1	2254529	50 / 15 / 50	63	1/2	63	20,5	4,6	3,9	3,1
620.177.00.1	2254540	65 / 25 / 65	75	1	75	21,6	5,4	4,5	3,5

4.6 GEBERIT FLOWFIT ÖVERGÅNGAR EJ LÖSTAGBARA

Geberit FlowFit övergång till Geberit Mepla

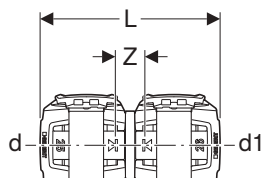
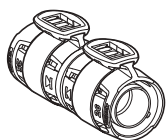

Artikelnr	RSK nr.	DN	d [mm]	d1 [mm]	L [cm]	Z [cm]
620.090.00.1	2257837	12	16	16	7,8	1,3
620.091.00.1	2257838	15	20	20	7,8	1,3
620.092.00.1	2257839	20	25	26	7,8	1,3
620.093.00.1	2257840	25	32	32	8,8	1,6
620.094.00.1	2257841	32	40	40	8,8	1,6
620.095.00.1	2257842	40	50	50	14	2,1
620.096.00.1	2257843	50	63	63	15	2,3
620.097.00.1	2257844	65	75	75	15	2,3

Geberit FlowFit övergång till Geberit Mapress, med slätända, rödgods

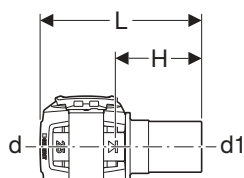
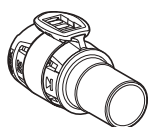

Artikelnr	RSK nr.	DN	d [mm]	d1 [mm]	L [cm]	H [cm]
620.230.00.1	2257819	12/10	16	12	6,8	3,5
620.240.00.1	2257826	12	16	15	6,9	3,6
620.231.00.1	2257820	15/12	20	15	6,9	3,6
620.241.00.1	2257827	15	20	18	6,9	3,6
620.242.00.1	2257828	15/20	20	22	7	3,7
620.232.00.1	2257821	20	25	22	7	3,7
620.233.00.1	2257822	25	32	28	7,7	4,1
620.234.00.1	2257823	32	40	35	8	4,4
620.235.00.1	2257824	40	50	42	12,8	6,9
620.236.00.1	2257825	50	63	54	13,8	7,5

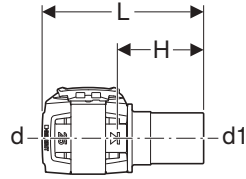
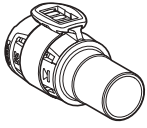
Geberit FlowFit övergång till Geberit Mapress, med slätända, rostfritt stål

Artikelnr	RSK nr.	DN	d [mm]	d1 [mm]	L [cm]	H [cm]
620.250.00.1	2257829	12	16	15	7,1	3,8
620.251.00.1	2257830	15	20	18	7,1	3,8
620.252.00.1	2257831	15/20	20	22	7,2	3,9
620.253.00.1	2257832	20	25	22	7,2	3,9
620.254.00.1	2257833	25	32	28	7,9	4,3
620.255.00.1	2257834	32	40	35	8,2	4,6
620.256.00.1	2257835	40	50	42	12,5	6,6
620.257.00.1	2257836	50	63	54	14,2	7,9

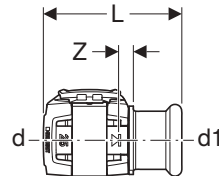
Geberit FlowFit övergång till Geberit Mapress, med pressmuff

Artikelnr	RSK nr.	DN	d [mm]	d1 [mm]	L [cm]	Z [cm]
620.329.00.1	2257810	12/10	16	12	5,4	0,6
620.332.00.1	2257811	12	16	15	5,6	0,6
620.333.00.1	2257812	15	20	18	5,6	0,6
620.334.00.1	2257813	15/20	20	22	5,7	0,6
620.335.00.1	2257814	20	25	22	5,7	0,6
620.336.00.1	2257815	25	32	28	6,4	0,8
620.337.00.1	2257816	32	40	35	6,7	0,8
620.338.00.1	2257817	40	50	42	9,7	1,1
620.339.00.1	2257818	50	63	54	10,7	1,2

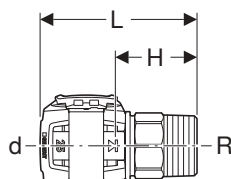
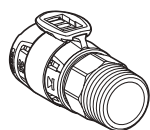
Geberit FlowFit övergång med utvändig gänga, kiselbrons

Artikelnr	RSK nr.	DN	d [mm]	R ["]	L [cm]	H [cm]	SW [mm]
620.300.00.1	2257789	12/10	16	3/8	6,1	2,8	18
620.310.00.1	2257797	12/15	16	1/2	6,1	2,8	22
620.320.00.1	2257804	12/20	16	3/4	6,5	3,2	27
620.301.00.1	2257790	15/10	20	3/8	6,1	2,8	18
620.311.00.1	2257798	15	20	1/2	6,4	3,1	22
620.321.00.1	2257805	15/20	20	3/4	6,5	3,2	27
620.302.00.1	2257791	20/15	25	1/2	6,4	3,1	22
620.312.00.1	2257799	20	25	3/4	6,8	3,5	27
620.322.00.1	2257806	20/25	25	1	6,6	3,3	34
620.303.00.1	2257792	25	32	1	7,5	3,9	34
620.313.00.1	2257800	25/32	32	1 1/4	7,2	3,6	43
620.304.00.1	2257793	32/25	40	1	7,4	3,8	47
620.314.00.1	2257801	32	40	1 1/4	7,4	3,8	47
620.324.00.1	2257807	32/40	40	1 1/2	7,3	3,7	49
620.305.00.1	2257794	40	50	1 1/2	10	4,1	59
620.315.00.1	2257802	40/50	50	2	10,4	4,4	60
620.306.00.1	2257795	50	63	2	11	4,7	74
620.316.00.1	2257803	50/65	63	2 1/2	11,3	4,9	76
620.307.00.1	2257796	65	75	2 1/2	11,4	5	86

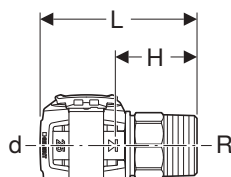
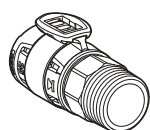
Geberit FlowFit övergång med utvändig gänga, rostfritt stål

Artikelnr	RSK nr.	DN	d [mm]	R ["]	L [cm]	H [cm]	SW [mm]
619.700.00.1	2257782	15	20	1/2	6,4	3,1	22
619.701.00.1	2257783	20	25	3/4	6,8	3,5	27
619.702.00.1	2257784	25	32	1	7,5	3,9	34
619.703.00.1	2257785	32	40	1 1/4	7,4	3,8	47
619.704.00.1	2257786	40	50	1 1/2	10	4,1	59
619.705.00.1	2257787	50	63	2	11	4,7	74
619.706.00.1	2257788	65	75	2 1/2	11,4	5	86

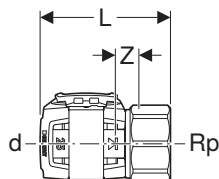
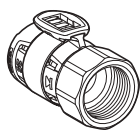
Geberit FlowFit övergång med invändig gänga

Artikelnr	RSK nr.	DN	d [mm]	Rp ["]	L [cm]	Z [cm]	SW [mm]
620.400.00.1	2257720	12/10	16	3/8	5,1	1	22
620.410.00.1	2257728	12/15	16	1/2	5,6	1,3	27
620.420.00.1	2257735	12/20	16	3/4	5,8	1,3	32
620.401.00.1	2257721	15/10	20	3/8	5,3	1,2	22
620.411.00.1	2257729	15	20	1/2	5,5	1,1	27
620.421.00.1	2257736	15/20	20	3/4	5,8	1,3	32
620.402.00.1	2257722	20	25	3/4	5,7	1,2	32
620.412.00.1	2257730	20/25	25	1	6,1	1,5	41
620.403.00.1	2257723	25	32	1	6,4	1,4	41
620.413.00.1	2257731	25/32	32	1 1/4	6,7	1,5	47
620.404.00.1	2257724	32/25	40	1	6,4	1,4	47
620.414.00.1	2257732	32	40	1 1/4	6,7	1,5	47
620.424.00.1	2257737	32/40	40	1 1/2	6,7	1,5	54
620.405.00.1	2257725	40	50	1 1/2	9,3	1,7	60
620.415.00.1	2257733	40/50	50	2	9,7	1,8	67
620.406.00.1	2257726	50	63	2	10,2	1,9	75
620.416.00.1	2257734	50/65	63	2 1/2	10,7	1,9	83
620.407.00.1	2257727	65	75	2 1/2	10,7	2,5	86

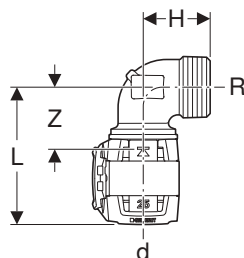
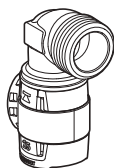
Geberit FlowFit böj 90° med utvändig gänga

Artikelnr	RSK nr.	DN	d [mm]	R ["]	L [cm]	H [cm]	Z [cm]
620.510.00.1	2253728	12/15	16	1/2	5,7	2,5	2,4
620.520.00.1	2253731	12/20	16	3/4	6	3,1	2,7
620.511.00.1	2253729	15	20	1/2	6,1	2,8	2,8
620.521.00.1	2253732	15/20	20	3/4	6	2,7	2,7
620.502.00.1	2253723	20	25	3/4	6	2,9	2,7
620.512.00.1	2253730	20/25	25	1	6,3	3,2	3
620.503.00.1	2253724	25	32	1	6,8	3,1	3,2
620.504.00.1	2253725	32	40	1 1/4	7,3	4,2	3,7
620.505.00.1	2253726	40	50	1 1/2	10,4	4,7	4,5
620.506.00.1	2253727	50	63	2	11,7	5,8	5,4

Geberit FlowFit böj 90° med utvändig gänga, lång

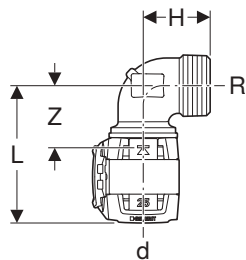
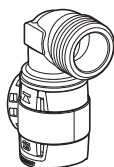

Artikelnr	RSK nr.	DN	d [mm]	R ["]	L [cm]	H [cm]	Z [cm]
620.522.00.1	2253733	12/15	16	1/2	5,7	3,7	2,4
620.523.00.1	2253734	12/20	16	3/4	6	4,5	2,7
620.524.00.1	2253735	15	20	1/2	6,1	3,7	2,8
620.525.00.1	2253736	15/20	20	3/4	6	4,5	2,7
620.526.00.1	2253737	20	25	3/4	6	4,5	2,7
620.527.00.1	2253738	20/25	25	1	6,3	5,6	3
620.528.00.1	2253739	25	32	1	6,8	5,6	3,2

Geberit FlowFit böj 90° med invändig gänga

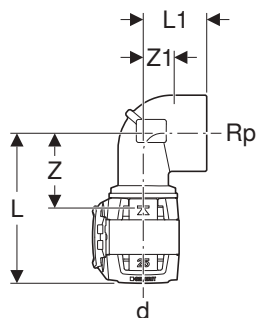
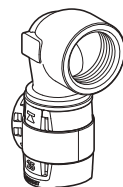

Artikelnr	RSK nr.	DN	d [mm]	Rp ["]	L [cm]	L1 [cm]	Z [cm]	Z1 [cm]
620.540.00.1	2253718	12/15	16	1/2	6,1	2,2	2,8	0,9
620.550.00.1	2253721	12/20	16	3/4	6,3	2,5	3	1,2
620.541.00.1	2253719	15	20	1/2	6,1	2,4	2,8	1,1
620.551.00.1	2253722	15/20	20	3/4	6,5	2,6	3,2	1,3
620.532.00.1	2253713	20	25	3/4	6,5	2,8	3,2	1,5
620.542.00.1	2253720	20/25	25	1	6,9	3	3,6	1,4
620.533.00.1	2253714	25	32	1	7,4	3,4	3,8	1,8
620.534.00.1	2253715	32	40	1 1/4	8,1	3,7	4,5	2,2
620.535.00.1	2253716	40	50	1 1/2	11,2	4,5	5,3	3
620.536.00.1	2253717	50	63	2	12,8	5,3	6,4	3,5

4.7 GEBERIT FLOWFIT ÖVERGÅNGAR OCH ANSLUTNINGAR, LÖSTAGBARA

Geberit FlowFit övergång med MasterFix

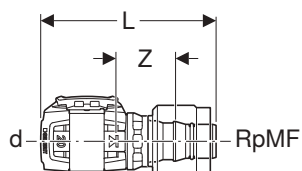
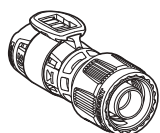

Artikelnr	RSK nr.	DN	d [mm]	RpMF ["]	L [cm]	Z [cm]
620.290.00.1	2257777	12/15	16	1/2	7,6	2,8
620.291.00.1	2257778	15	20	1/2	7,6	2,8

Geberit FlowFit övergångsvinkel 90° med MasterFix

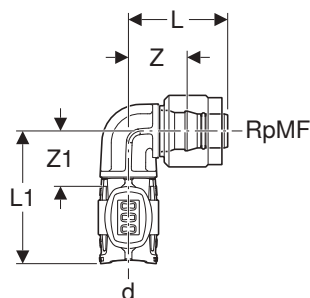

Artikelnr	RSK nr.	DN	d [mm]	RpMF ["]	L [cm]	L1 [cm]	Z [cm]	Z1 [cm]
620.490.00.1	2257848	12/15	16	1/2	4,3	5,8	2,7	2,5
620.491.00.1	2257849	15	20	1/2	4,3	5,8	2,8	2,5

Geberit FlowFit adapter-T-rör med MasterFix, genomgång

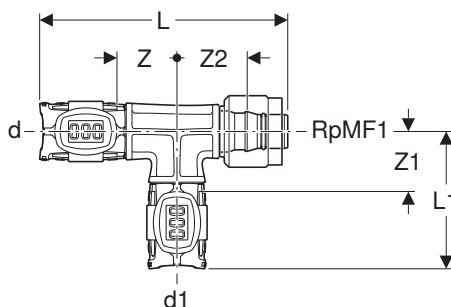
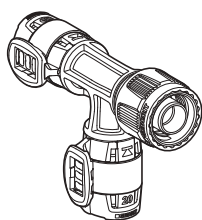

Artikelnr	RSK nr.	DN	d [mm]	d1 [mm]	RpMF1 ["]	L [cm]	L1 [cm]	Z [cm]	Z1 [cm]	Z2 [cm]
620.380.00.1	2257669	12 / 15 / 12	16	16	1/2	11,5	4,3	2,5	2,7	2,5
620.381.00.1	2257670	15 / 15 / 12	20	16	1/2	11,5	4,3	2,5	2,8	2,5
620.391.00.1	2257672	15	20	20	1/2	11,5	4,3	2,5	2,8	2,5
620.382.00.1	2257671	20 / 15 / 15	25	20	1/2	11,5	4,1	2,5	2,6	2,5
620.392.00.1	2257673	20 / 15 / 20	25	25	1/2	11,5	4,1	2,5	2,6	2,5

Geberit FlowFit adapter-T-rör med MasterFix, grenrör

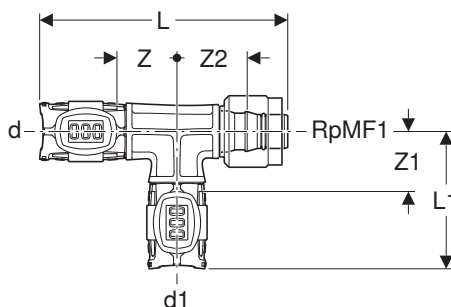
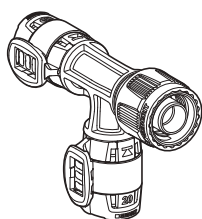

Artikelnr	RSK nr.	DN	d [mm]	d1 [mm]	RpMF1 ["]	L [cm]	L1 [cm]	Z [cm]	Z1 [cm]	Z2 [cm]
620.780.00.1	2257674	12/12/15	16	16	1/2	10,4	5,8	2,5	2,5	3,1
620.781.00.1	2257675	15	20	20	1/2	10,8	6	2,7	2,7	3,3

Geberit FlowFit skruvkoppling

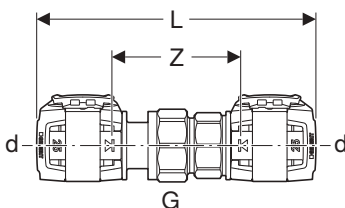
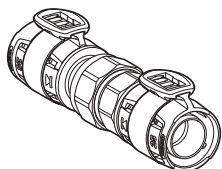

Artikelnr	RSK nr.	DN	d [mm]	G ["]	L [cm]	Z [cm]	SW [mm]
620.570.00.1	2257690	12	16	1/2	11,5	5	24
620.571.00.1	2257691	15	20	1/2	11,7	5,2	24
620.572.00.1	2257692	20	25	3/4	12,1	5,6	30
620.573.00.1	2257693	25	32	1	13,9	6,7	38
620.574.00.1	2257694	32	40	1 1/4	13,9	6,7	46
620.575.00.1	2257695	40	50	1 1/2	19,1	7,2	55
620.576.00.1	2257696	50	63	2	20,5	7,8	67

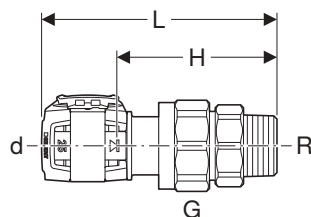
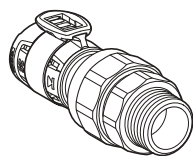
Geberit FlowFit unionskoppling med utvärdig gänga

Artikelnr	RSK nr.	DN	d [mm]	R ["]	G ["]	L [cm]	H [cm]	SW [mm]
620.580.00.1	2257707	12/15	16	1/2	3/4	8,7	5,4	30
620.581.00.1	2257708	15	20	1/2	3/4	9,3	6	30
620.591.00.1	2257714	15/20	20	3/4	1	9,4	6,1	30
620.582.00.1	2257709	20	25	3/4	1	10,2	6,9	38
620.583.00.1	2257710	25	32	1	1 1/4	10,5	6,9	46
620.593.00.1	2257715	25/32	32	1 1/4	1 1/2	10,8	7,2	46
620.584.00.1	2257711	32	40	1 1/4	1 1/2	11,3	7,7	55
620.594.00.1	2257716	32/40	40	1 1/2	1 3/4	11,3	7,7	55
620.585.00.1	2257712	40	50	1 1/2	1 3/4	14,9	9	62
620.595.00.1	2257717	40/50	50	2	2 3/4	14,9	8,9	67
620.586.00.1	2257713	50	63	2	2 3/4	15,3	8,9	89
620.596.00.1	2257718	50/65	63	2 1/2	2 3/4	15,5	9,2	89

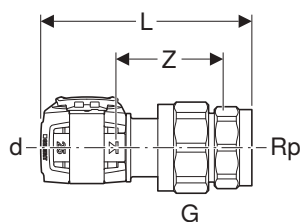
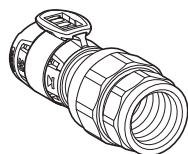
Geberit FlowFit unionskoppling med invändig gänga

Art.-nr	RSK nr.	DN	d [mm]	Rp ["]	G ["]	L [cm]	Z [cm]	SW [mm]
620.600.00.1	2257697	12/15	16	1/2	3/4	7,9	3,3	30
620.601.00.1	2257698	15	20	1/2	3/4	8,5	3,9	30
620.602.00.1	2257699	20	25	3/4	1	9,2	4,4	38
620.603.00.1	2257700	25	32	1	1 1/4	9,4	4,1	46
620.613.00.1	2257704	25/32	32	1 1/4	1 1/4	10,6	5,1	46
620.604.00.1	2257701	32	40	1 1/4	1 1/2	10,9	5,4	55
620.614.00.1	2257705	32	40	1 1/2	1 1/2	11,2	5,6	55
620.605.00.1	2257702	40	50	1 1/2	1 1/2	13,8	5,9	55
620.615.00.1	2257706	40/50	50	2	2	14,9	6,6	67
620.606.00.1	2257703	50	63	2	2 3/4	13,3	4,3	89

Geberit FlowFit övergång med löpande mutter

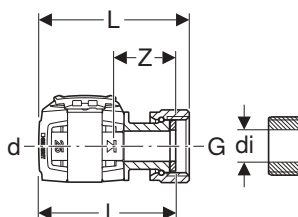
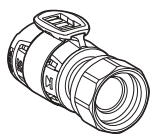

Artikelnr	RSK nr.	DN	d [mm]	di [mm]	G ["]	L [cm]	l [cm]	Z [cm]
620.620.00.1	2257741	12	16	9	3/8	6,2	5,5	2,2
620.630.00.1	2257748	12/15	16	11	1/2	6,4	5,7	2,4
620.640.00.1	2257755	12/20	16	17	3/4	5,9	5,2	1,9
620.650.00.1	2257762	12/25	16	21	1	6,2	5,4	2,1
620.621.00.1	2257742	15/12	20	9	3/8	6,2	5,5	2,2
620.631.00.1	2257749	15	20	11	1/2	6,4	5,7	2,4
620.641.00.1	2257756	15/20	20	16	3/4	6,5	5,8	2,5
620.651.00.1	2257763	15/25	20	21	1	6,3	5,5	2,2
620.661.00.1	2257769	15/32	20	27	1 1/4	6,6	5,6	2,3
620.671.00.1	2257773	15/40	20	32	1 1/2	6,2	5	1,7
620.622.00.1	2257743	20/15	25	11	1/2	6,4	5,7	2,4
620.632.00.1	2257750	20	25	15	3/4	6,5	5,8	2,5
620.642.00.1	2257757	20/25	25	20	1	7,3	6,3	3
620.652.00.1	2257764	20/32	25	27	1 1/4	6,8	5,8	2,5
620.662.00.1	2257770	20/40	25	32	1 1/2	7,1	5,9	2,6
620.672.00.1	2257774	15/30	20	23	1 1/8	6,4	5,5	2,2
620.623.00.1	2257744	25/20	32	16	3/4	7	6,3	2,7
620.633.00.1	2257751	25	32	20	1	7,8	6,8	3,2
620.643.00.1	2257758	25/32	32	27	1 1/4	7,4	6,4	2,8
620.653.00.1	2257765	25/40	32	32	1 1/2	7,6	6,4	2,8
620.663.00.1	2257771	25/50	32	42	2	7,5	6,2	2,6
620.673.00.1	2257775	20/50	25	42	2	6,3	5	1,7
620.624.00.1	2257745	32	40	27	1 1/4	7,9	6,9	3,3
620.634.00.1	2257752	32	40	33	1 1/2	8	6,9	3,3
620.644.00.1	2257759	32/50	40	42	2	7,8	6,5	2,9
620.654.00.1	2257766	32/65	40	42	2 1/4	7,7	6,3	2,7
620.625.00.1	2257746	40	50	33	1 1/2	10,6	9,5	3,6
620.635.00.1	2257753	40	50	33	1 3/4	11,5	10,2	4,3
620.645.00.1	2257760	40/50	50	42	2	11	9,9	3,9
620.655.00.1	2257767	40/50	50	42	2 1/4	10,8	9,4	3,5
620.665.00.1	2257772	40/50	50	52	2 3/8	10,9	9,4	3,5
620.675.00.1	2257776	40/65	50	62	2 3/4	10,7	9,1	3,2
620.626.00.1	2257747	50/50	63	42	2	11,5	10,4	4
620.636.00.1	2257754	50/50	63	52	2 3/8	11,6	10,5	4,1
620.646.00.1	2257761	50/65	63	54	2 1/2	11,8	10,2	3,9
620.656.00.1	2257768	50/65	63	62	2 3/4	11,5	9,9	3,6

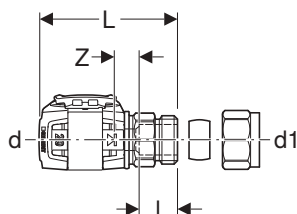
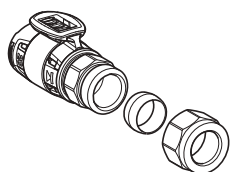
Geberit FlowFit övergång med klämringskoppling

Artikelnr	RSK nr.	DN	d [mm]	d1 [mm]	L [cm]	I [cm]	Z [cm]
620.680.00.1	2257738	12/10	16	12	5,8	1,7	0,8
620.690.00.1	2257740	12	16	15	5,8	1,6	0,9
620.681.00.1	2257739	15/12	20	15	6	1,6	1,1

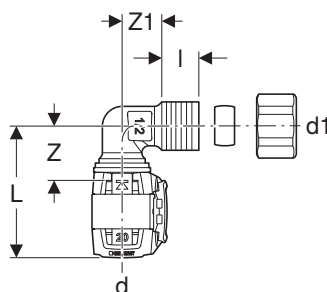
Geberit FlowFit övergångsvinkel 90° med klämringskoppling

Artikelnr	RSK nr.	DN	d [mm]	d1 [mm]	L [cm]	I [cm]	Z [cm]	Z1 [cm]	SW [mm]
620.700.00.1	2257845	12/10	16	12	5,5	0,8	2,2	1,7	24
620.710.00.1	2257847	12	16	15	5,5	0,8	2,2	1,7	24
620.701.00.1	2257846	15/12	20	15	5,7	0,8	2,4	1,7	24

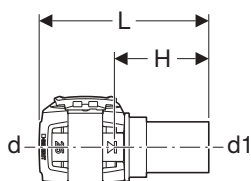
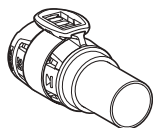
Geberit FlowFit övergång till klämringskoppling för kopparrör

Artikelnr	RSK nr.	DN	d [mm]	d1 [mm]	L [cm]	H [cm]
620.720.00.1	2257719	12	16	15	7	3,7
620.721.00.1	2257808	15/12	20	15	7	3,7
620.722.00.1	2257809	20	25	22	7,4	4,1

Geberit FlowFit övergång med skruvkoppling till PEX-rör

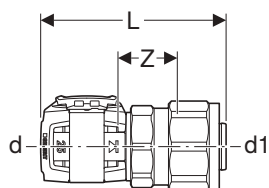
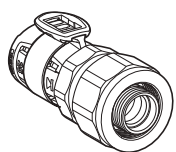

Artikelnr	RSK nr.	DN	d [mm]	G ["]	d1 [mm]	s1 [mm]	L [cm]	Z [cm]	PN [bar]
620.730.00.1	2257779	12	16	3/4	16	1,5	7,8	3,1	6
620.731.00.1	2257780	15	20	3/4	20	1,9	7,8	3,1	6
620.732.00.1	2257781	20	25	1	25	2,3	8	3,3	6

Geberit FlowFit fläns PN6, med pressenhet

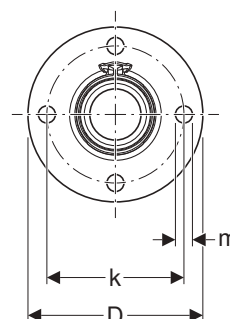
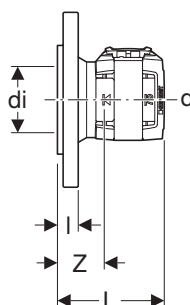
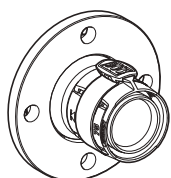

Artikelnr	RSK nr.	DN	d [mm]	di [mm]	D [cm]	k [cm]	m [cm]	L [cm]	l [cm]	Z [cm]	n [ST]	PN [bar]
619.616.00.1	2256041	65	75	70	16	130	14	11,3	2,4	5	4	6
619.617.00.1	2256040	65	75	70	18,5	145	18	11,3	2,4	5	4	10/16

4.8 GEBERIT FLOWFIT FÖRSLUTNINGAR

Geberit FlowFit rörändplugg

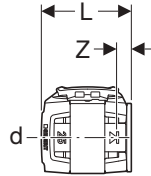

Artikelnr	RSK nr.	DN	d [mm]	L [cm]	Z [cm]
620.740.00.1	2256841	12	16	3,9	0,6
620.741.00.1	2256842	15	20	3,9	0,6
620.742.00.1	2256843	20	25	3,9	0,6

4.9 GEBERIT FLOWFIT ANSLUTNINGAR

Geberit FlowFit anslutningsvinkel 90°

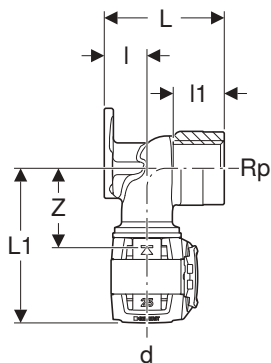
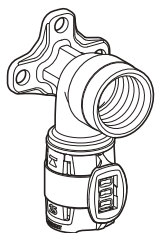

Artikelnr	RSK nr.	DN	d [mm]	Rp ["]	L [cm]	L1 [cm]	I [cm]	I1 [cm]	Z [cm]
620.750.00.1	2257678	12	16	3/8	3,6	6	1,9	1,3	2,7
620.751.00.1	2257679	15	20	3/8	3,6	6	1,9	1,3	2,7
620.760.00.1	2257680	12	16	1/2	3,6	6	1,9	1,3	2,8
620.761.00.1	2257681	15	20	1/2	3,6	6,3	1,9	1,3	3,1
620.810.00.1	2257687	12	16	1/2	5,2	6	1,9	1,5	2,7
620.811.00.1	2257688	15	20	1/2	5,2	6	1,9	1,7	3,1
620.821.00.1	2257689	15	20	3/4	5,2	6,3	1,9	1,9	3
620.802.00.1	2257686	20	25	3/4	5,2	6,7	1,9	1,9	3,4
620.770.00.1	2257682	12	16	1/2	7,8	6,8	1,9	3	3,5
620.771.00.1	2257683	15	20	1/2	7,8	7,3	1,9	3	4
620.800.00.1	2257684	12	16	3/8	5,2	6	1,9	1,5	2,7
620.801.00.1	2257685	15	20	3/8	5,2	6	1,9	1,5	2,7

4.10 GEBERIT FLOWFIT FÖRDELARE MED GÄNGAD ANSLUTNING

Geberit FlowFit anslutning för grenrör för Eurokona

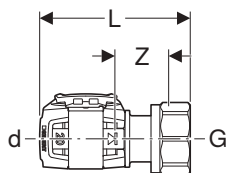

Artikelnr	RSK nr.	DN	d [mm]	G ["]	L [cm]	Z [cm]	SW [mm]
620.330.00.1	2257676	12/20	16	3/4	6,1	2,6	27
620.331.00.1	2257677	15/20	20	3/4	6,5	3,1	27

4.11 GEBERIT FLOWFIT FÄSTE FÖR SYSTEMRÖR

Geberit fixpunktmontering

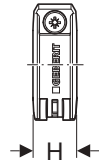
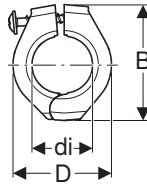
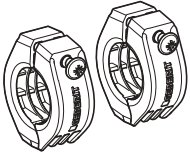

Artikelnr	RSK nr.	di [mm]	D [cm]	B [cm]	H [cm]
619.730.00.1	2054972	16	3,1	4	1,9
619.731.00.1	2054973	20	3,5	4,4	1,9
619.732.00.1	2054974	25	4	4,9	1,9
619.733.00.1	2054975	32	4,7	5,6	1,9
619.734.00.1	2054976	40	5,6	6,5	1,9
619.735.00.1	2054977	50	6,6	7,8	2,2
619.736.00.1	2054978	63	8	9,1	2,2
619.737.00.1	2054979	75	9,2	10,3	2,2

4.12 GEBERIT FLOWFIT TILLBEHÖR

Geberit läcksökningspray



Artikelnr	RSK nr.
690.942.00.1	2258438