



Main characteristics

- Register with integrated radio communication and data logger
- LC-display for consumption and status information
- Secured encrypted data transmission
- Meter with MID pattern approval acc. to annex MI001
- Exchangeable metrological unit with MID pattern approval acc. to annex MI001
- Unique measuring range; $Q_3/Q_1 \geq 100$
- High overload capability
- No straight inlet length necessary (U0D0 acc. to OIML R49 and ISO 4064-1:2014)
- Installation position horizontal and vertical
- Meter body in short (WP) and long (WS) overall length acc. to DIN 19625 and ISO 4064-1:2014 available
- Meter can be submerged; protection class IP68
- Used materials are temperature resistant up to 70 °C

Applications

- Radio equipped watermeter for walk-by/drive-by readout applications
- Metering endpoint in radio based Smart Water Networks
- Measurement for billing of potable water up to 50 °C
- Measurement of high flowrates e.g. in pumped pipes
- Measurement of low flow e. g. in light load periods
- For leakage detection

Available options

- Version free of copper alloy for aggressive water
- Radio communication with different frequencies
- ¼" pressure monitoring port

Performance Data

Metrological Data acc. to Manufacturers Values

	Size	DN	40	50	65	80	100
Q_s	Max. Peak Flow	m ³ /h	60	90	120	200	300
Q_3'	Continuous Flow	m ³ /h	40	50	70	120	230
Q_{2h}	Transitional Flowrate horizontal	m ³ /h	0.32	0.4	0.63	0.51	0.81
Q_{1h}'	Minimum Flow horizontal	m ³ /h	0.2	0.15	0.2	0.2	0.3
Q_{2v}	Transitional Flowrate vertical	m ³ /h	0.4	0.51	0.81	0.8	1.28
Q_{1v}'	Minimum Flow vertical	m ³ /h	0.25	0.28	0.4	0.5	0.5
	Starting Flow	m ³ /h	0.05	0.05	0.07	0.1	0.11





	Size	DN	125	150	200	250	300
Q_s	Max. Peak Flow	m ³ /h	350	600	1200	1600	2000
Q_3'	Continuous Flow	m ³ /h	250	450	800	1250	1400
Q_{2h}	Transitional Flowrate horizontal	m ³ /h	1.02	1.6	4.0	6.3	16.0
Q_{1h}'	Minimum Flow horizontal	m ³ /h	0.5	0.8	2.0	3.5	9.0
Q_{2v}	Transitional Flowrate vertical	m ³ /h	1.6	3.2	4.0	10.1	25.4
Q_{1v}'	Minimum Flow vertical	m ³ /h	1	1.6	2.5	6.3	15.9
	Starting Flow	m ³ /h	0.15	0.3	1.5	3	8

Metrological Data acc. to 2014/32/EU (MID)

	Size	DN	40	50	65	80	100
Q_4	Overload Flowrate acc. to MID	m ³ /h	31.25	50	78.75	125	200
Q_3	Permanent Flowrate acc. to MID	m ³ /h	25	40	63	100	160
Q_{2h}	Transitional Flowrate horizontal acc. to MID	m ³ /h	0.32	0.4	0.63	0.51	0.81
Q_{1h}	Minimum Flowrate horizontal acc. to MID	m ³ /h	0.2	0.25	0.39	0.32	0.51
Q_{2v}	Transitional Flowrate vertical acc. to MID	m ³ /h	0.4	0.51	0.81	0.8	1.28
Q_{1v}	Minimum Flowrate vertical acc. to MID	m ³ /h	0.25	0.32	0.5	0.5	0.8
Q_3/Q_1 h	Max. Ratio horizontal		125	160	160	315	315
Q_3/Q_1 v	Max. Ratio vertical		63	100	100	125	160
Q_3/Q_1	Standard Marking		63	100	100	100	100
Δp	Headloss at Q_3 acc. to ISO 4064-1:2014	bar	0.1	0.16	0.32	0.16	0.34

	Size	DN	125	150	200	250	300
Q_4	Overload Flowrate acc. to MID	m ³ /h	200	500	787.5	787.5	1250
Q_3	Permanent Flowrate acc. to MID	m ³ /h	160	400	630	630	1000
Q_{2h}	Transitional Flowrate horizontal acc. to MID	m ³ /h	1.02	1.6	4.03	8.06	25.4
Q_{1h}	Minimum Flowrate horizontal acc. to MID	m ³ /h	0.64	1	2.52	5.04	15.9
Q_{2v}	Transitional Flowrate vertical acc. to MID	m ³ /h	1.6	3.2	4.03	10.1	25.4
Q_{1v}	Minimum Flowrate vertical acc. to MID	m ³ /h	1	2	5.52	6.3	15.9
Q_3/Q_1 h	Max. Ratio horizontal		250	400	250	125	63
Q_3/Q_1 v	Max. Ratio vertical		125	200	250	100	63
Q_3/Q_1	Standard Marking		100	100	100	100	63
Δp	Headloss at Q_3 acc. to ISO 4064-1:2014	bar	0.19	0.27	0.11	0.07	0.08

Dial

-  Alarm is triggered
-  Low battery level is reached
-  Radio is activated
-  System is set up in hydraulic testing mode
- $\oplus \ominus$ indicates positive or negative flow
- m^3 indicates the unit

Nominal diameter DN	Smallest reading m^3	Max. reading m^3
40 ... 125	0.001	999,999.999
150 ... 300	0.01	9,999,999.99

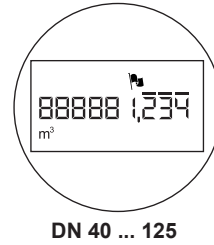

Typical Headloss

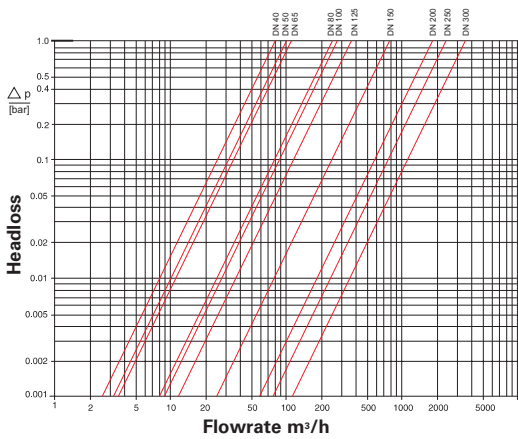

Typical Error Curve

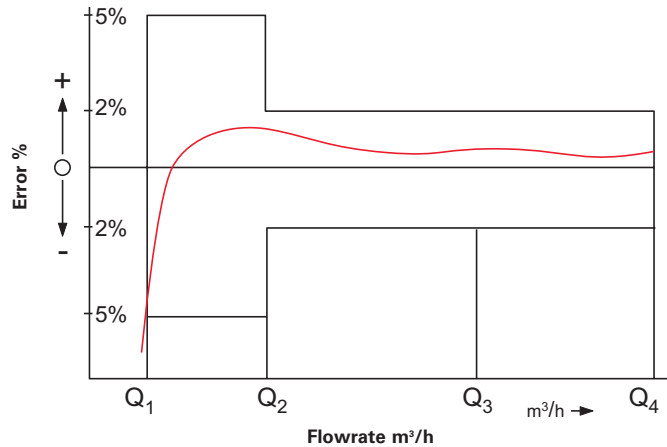

Installation

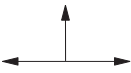
Pipe	horizontal vertical	
Meter head	upwards sideways	

Installation Requirements

- Unrestricted straight pipe upstream $0 \times DN$
- No abrupt restrictions directly downstream of the meter

Materials

Body	Cast iron (PN16)
Measuring element	Plastic
Rotor	Plastic
Battery	Lithium
We also use the following materials	Brass Stainless steel

Dimension Picture

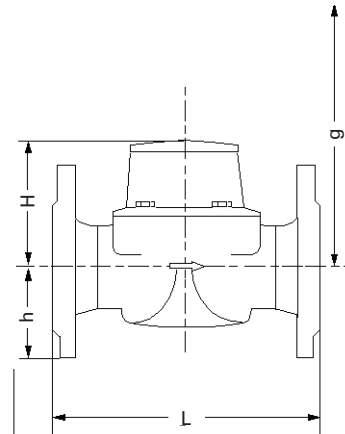

Available Lengths

Nominal diameter		40	50	65	80	100	125	150	200	250	300
Overall length L WS (DIN / ISO)	mm		270 / 300	300	300 / 350	360 / 350		500			
Overall length L WP (DIN / ISO)	mm	220	200	200	225 / 200	250	250	300	350	450	500

Approval Mark

Meter cpl. and exchangeable metrological unit

Marking CE M-XX* 0102

DN 40 ... 150 DE-09-MI001-PTB 010
DN 200 ... 300 DE-15-MI001PTB 014

Environmental Conditions

Acc. to ISO 4064-1:2014

Environmental class B

Environmental temperature 5-70 °C

Electromagnetic environmental class E1

* year of production

Order example

_____	Type
_____	Size
_____	Max. medium temperature
_____	Nominal pressure
MeiStream, DN 50, T50, PN16	
Drilling EN 1092 PN16 _____	Drilling pattern
Length 270 mm _____	Body length
eRegister / m ³ _____	Register type / unit
with MID conformity _____	Approval standard

Dimensions and Weights

Dimensions

Nominal diameter		DN	40	50	50	50	65	65
Overall length	L	mm	220	200	270	300	200	300
Height	H	mm	120	120	120	120	120	120
	h	mm	69	73	73	73	85	85
Dismantling height	g	mm	200	200	200	200	200	200

Nominal diameter		DN	80	80	80	80	100	100	100
Overall length	L	mm	200	225	300	350	250	350	360
Height	H	mm	150	150	150	150	150	150	150
	h	mm	95	95	95	95	105	105	105
Dismantling height	g	mm	270	270	270	270	270	270	270

Nominal diameter		DN	125	150	150	200	250	300
Overall length	L	mm	250	300	500	350	450	500
Height	H	mm	160	177	177	214	238	264
	h	mm	118	135	135	162	194	226
Dismantling height	g	mm	280	356	356	449	474	499

Weight PN16

Nominal diameter		DN	40	50	50	50	65	65
Overall length	L	mm	220	200	270	300	200	300
Meter cpl.		kg	7.5	7.8	9.6	9.9	10.1	12.0
Measuring unit		kg	1.5	1.5	1.5	1.5	1.5	1.5
Body		kg	6.0	6.3	8.1	8.4	8.6	10.5

Nominal diameter		DN	80	80	80	80	100	100	100
Overall length	L	mm	200	225	300	350	250	350	360
Meter cpl.		kg	13.8	14.2	16.3	17.7	18.2	20.0	20.2
Measuring unit		kg	3.2	3.2	3.2	3.2	3.2	3.2	3.2
Body		kg	10.6	11.0	13.1	14.5	15.0	16.8	17.0

Nominal diameter		DN	125	150	150	200	250	300
Overall length	L	mm	250	300	500	350	450	500
Meter cpl.		kg	20.7	35.9	44.2	56.9	79.4	103.8
Measuring unit		kg	3.2	5.9	5.9	9.6	9.6	9.6
Body		kg	17.5	30.0	38.3	47.3	69.8	94.2

Weight PN40

Nominal diameter		DN	50	50	65	80	80	100	100	150	150
Overall length	L	mm	200	270	300	225	300	250	360	300	500
Meter cpl.		kg	9.7	10.7	13.1	17	18.6	20.4	22.9	44.6	52.9
Measuring unit		kg	1.7	1.7	1.7	4	4	4	4	9.3	9.3
Body		kg	8	9	11.4	14.6	14.6	16.4	18.9	35.3	43.6

MeiStreamRF infrastructure

The MeiStreamRF has SensusRF integrated technology providing the advantages of both uni- and bidirectional system architecture as described below. SensusRF is the optimized license free radio system for battery driven endpoints and repeaters. Scalable for mobile and remote reading without exchange of components, it is available in 433 MHz and 868 MHz.

OMS® compatible.

SensusRF offers two communication modes

1. Fixed Radio Network

- Auto configuration wizard (gateway sniffing for endpoints and repeaters)
- Integrating repeaters (up to 7 hops in a chain)
- Self-healing network (using alternative routes)
- Meter reading transparent and local
- Fast track alarms
- DMA snap shot (snap shot of a water network for evaluation)
- TCP/IP technology for the WAN communication
- High level of data security (end-to-end encryption)
- Enables cloud technologies, FTP and other remote database applications

2. Mobile read - Walk-by / Drive-by

- Unidirectional telegrams
- Bidirectional communication
- Spontaneous reception possible without route
- Configuration of the endpoint

SIRT (Sensus Interface Radio Tool)

SIRT is a radio modem for SensusRF radio, connected to a handheld via Bluetooth and using SensusREAD Mobile Reading software with the following features:

- Installation and readout of devices
- Reception of frequently transmitted radio messages from Sensus RF radio endpoints
- Request additional information from the radio endpoints
- Change configuration of radio endpoints (alarm, level settings...)

For further information please refer to the SensusRF brochure.

MeiStreamRF Fixed radio network - Remote Access & Monitoring

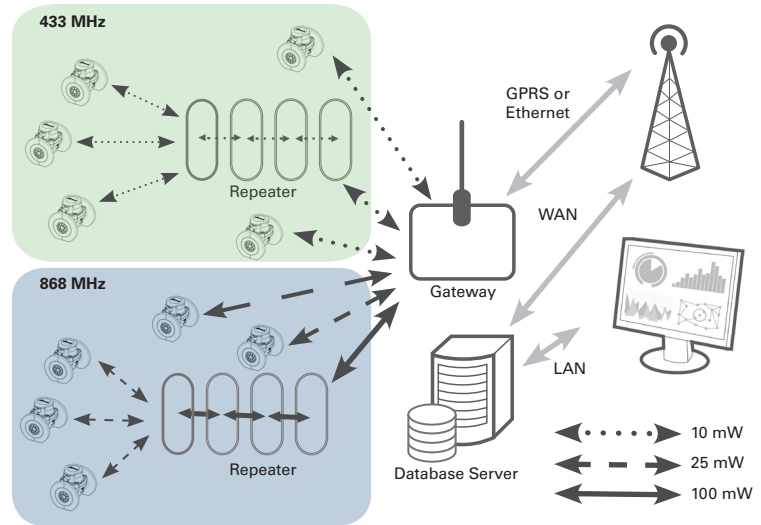

Unidirectional/Bidirectional communication

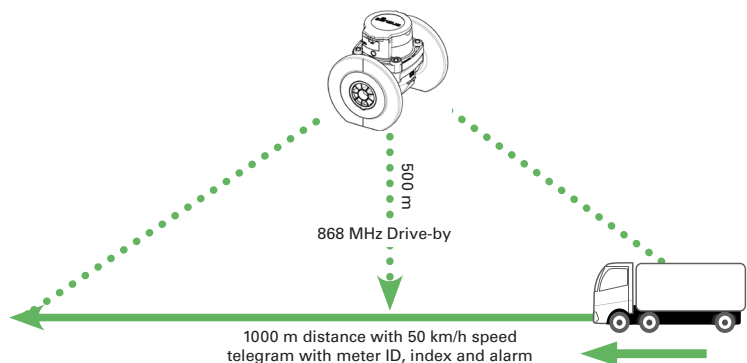
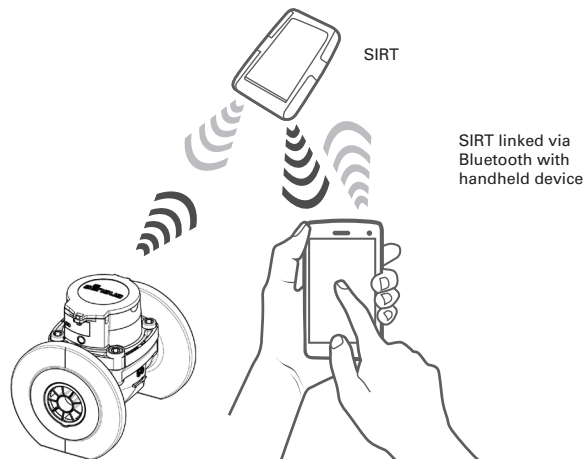

qualityaustria
Succeed with Quality

Certified according to ISO 9001
Quality Management System Quality Austria Reg.no. 3496/0

UK & Ireland Enquiries

Sensus UK Systems Ltd, 3 Lindenwood Crockford Lane, Chineham Business Park
Basingstoke RG24 8QY UK
T: +44 (0) 1256 372800 F: +44 (0) 1256 707203 Email: info.gb@xyleminc.com www.sensus.com

International Enquiries

Sensus GmbH Ludwigshafen, Industriestrasse 16, 67063 Ludwigshafen Germany
T: +49 (0) 621-6904-0 F: +49 (0) 621-6904-1409 Email: info.int@xyleminc.com www.sensus.com