

ALESSI SWAN

design Mario Trimarchi, 2017

INSTALLATION AND MAINTENANCE GUIDE



by



Contents

CZ Obsah	FI Sisällysluettelo	NL Inhoud	SE Innehållsförteckning
DE Inhaltsübersicht	FR Sommaire	NO Innhold	SK Obsah
DK Indholdsfortegnelse	IT Indice	PL Spis treści	UA Зміст
EE Sisukord	LT Turinys	RO Cuprins	
ES Contenidos	LV Saturs	RU Содержание	

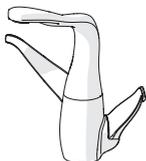

Technical data.....	4-5
Installation	6-12
Operation.....	13-14
Maintenance	15-23
Spare parts	24-25

8220F

EN 15091
 I (ISO 3822) Oras Lab.
 100 – 1000 kPa
 0.2 l/s (300 kPa)
 300 kpa (0.2 l/s)
 max. +70°C

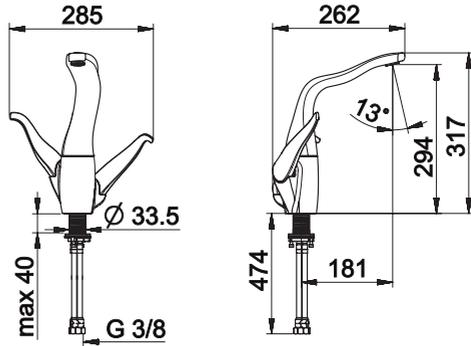

8222F

EN 15091
 I (ISO 3822) Oras Lab.
 100 – 1000 kPa
 0.2 l/s (300 kPa)
 300 kpa (0.2 l/s)
 max. +70°C
 IP 55
 CR2450 3V
 12 V

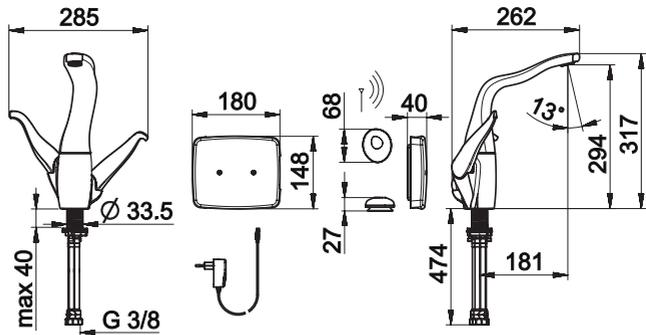

8225F

EN 15091
 I (ISO 3822) Oras Lab.
 100 – 1000 kPa
 0.2 l/s (300 kPa)
 300 kpa (0.2 l/s)
 max. +70°C
 IP 55
 CR2450 3V
 12 V

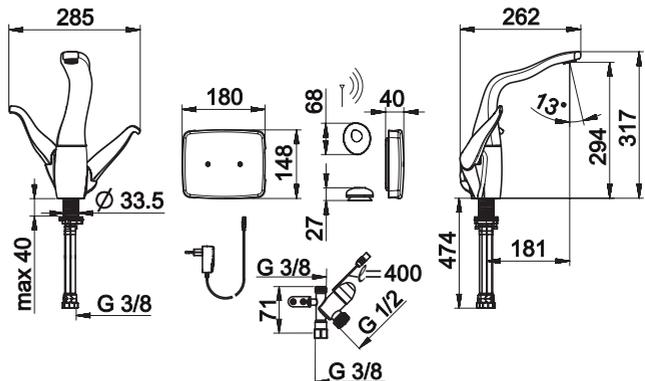

8223F

EN 15091
 I (ISO 3822) Oras Lab.
 100 – 1000 kPa
 0.2 l/s (300 kPa)
 300 kpa (0.2 l/s)
 max. +70°C
 IP 55
 CR2450 3V
 12 V

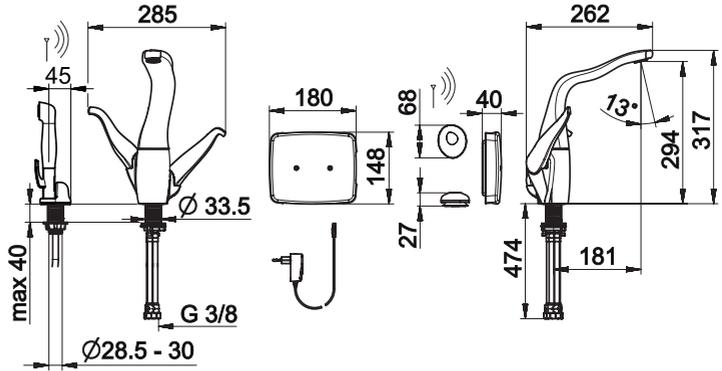

8227F

EN 15091
 I (ISO 3822) Oras Lab.
 100 – 1000 kPa
 0.2 l/s (300 kPa)
 300 kpa (0.2 l/s)
 max. +70°C
 IP 55
 CR2450 3V
 12 V

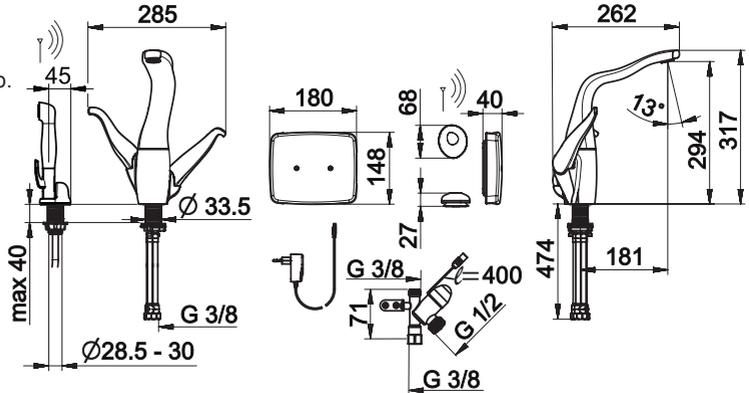

Installation

CZ Montáž
DE Montage
DK Installation
EE Paigaldus
ES Montaje

FI Asennus
FR Installation
IT Montaggio
LT Montavimas
LV Montāža

NL Installatie
NO Montering
PL Instalacja
RO Instalare
RU Установка

SE Installation
SK Inštalácia
UA Встановлення

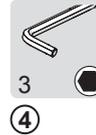
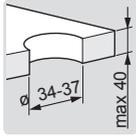

max. 1600 kPa

1

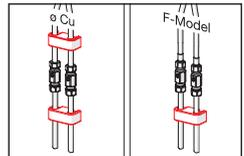
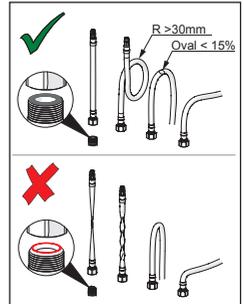
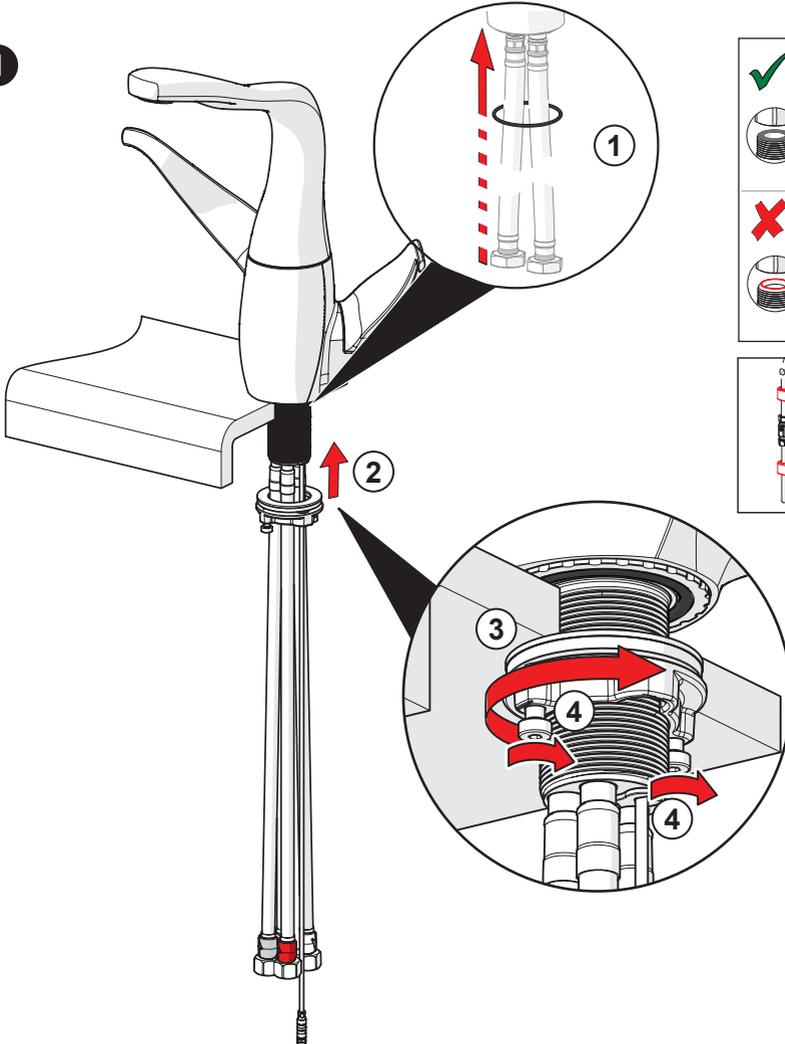

Installation

CZ Montáž
DE Montage
DK Installation
EE Paigaldus
ES Montaje

FI Asennus
FR Installation
IT Montaggio
LT Montavimas
LV Montāža

NL Installatie
NO Montering
PL Instalacja
RO Instalare
RU Установка

SE Installation
SK Inštalácia
UA Встановлення



1 2 3

4

2 A

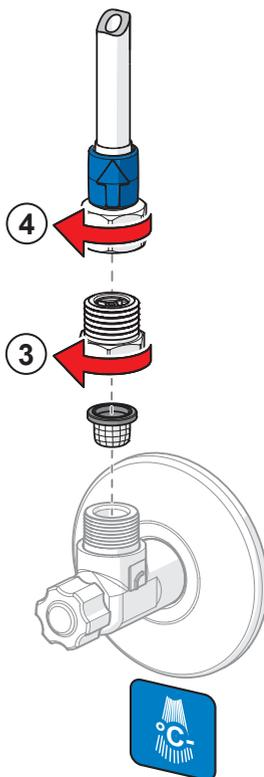
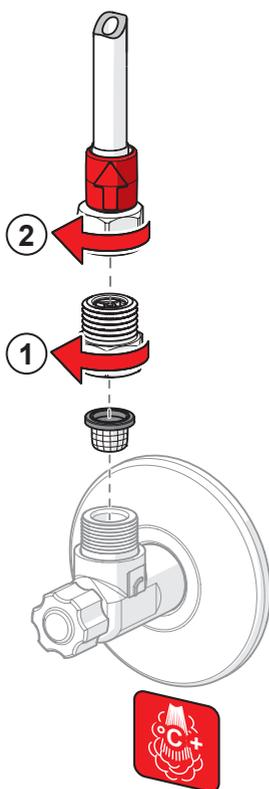

Installation

CZ Montáž

DE Montage

DK Installation

EE Paigaldus

ES Montaje

FI Asennus

FR Installation

IT Montaggio

LT Montavimas

LV Montāža

NL Installatie

NO Montering

PL Instalacja

RO Instalare

RU Установка

SE Installation

SK Inštalácia

UA Встановлення

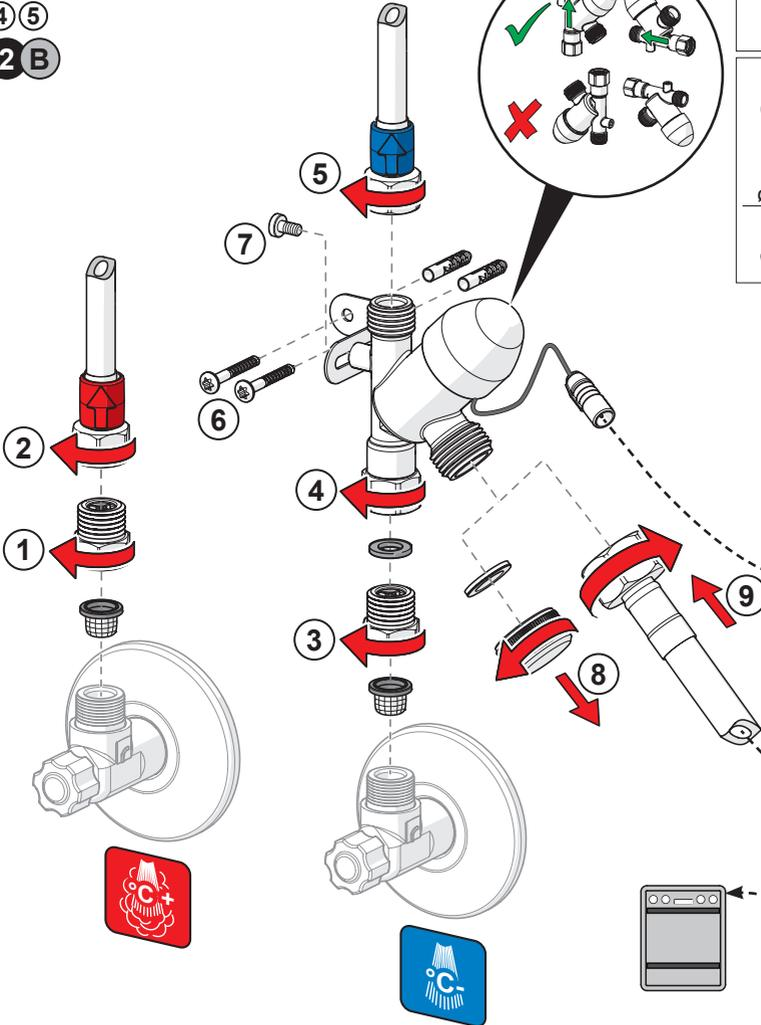
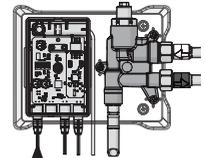
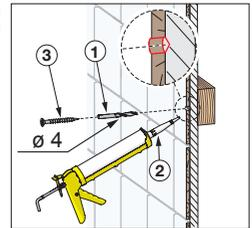
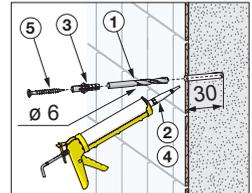
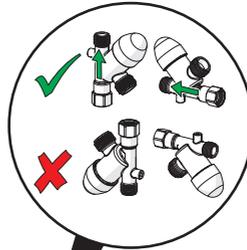
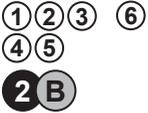
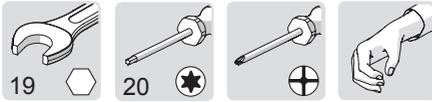

Installation

CZ Montáž

DE Montage

DK Installation

EE Paigaldus

ES Montaje

FI Asennus

FR Installation

IT Montaggio

LT Montavimas

LV Montāža

NL Installatie

NO Montering

PL Instalacja

RO Instalare

RU Установка

SE Installation

SK Inštalácia

UA Встановлення

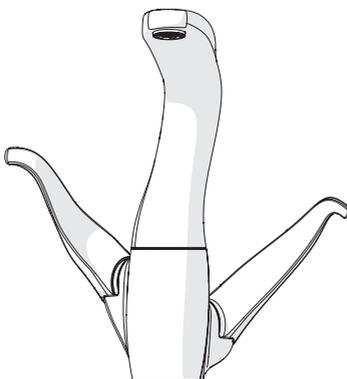

C

A

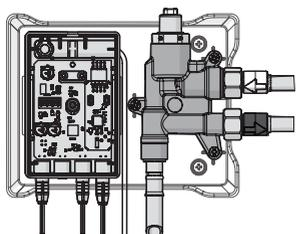

B

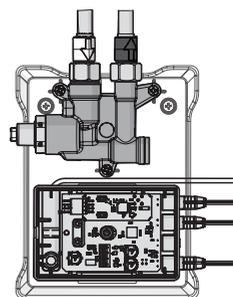
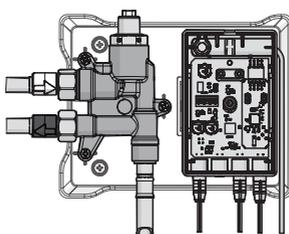

Installation

CZ Montáž
DE Montage
DK Installation
EE Paigaldus
ES Montaje

FI Asennus
FR Installation
IT Montaggio
LT Montavimas
LV Montāža

NL Installatie
NO Montering
PL Instalacja
RO Instalare
RU Установка

SE Installation
SK Inštalácia
UA Встановлення



3

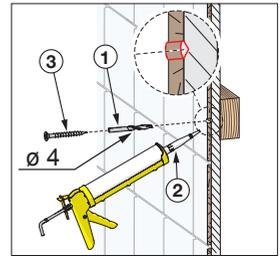
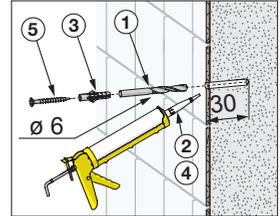
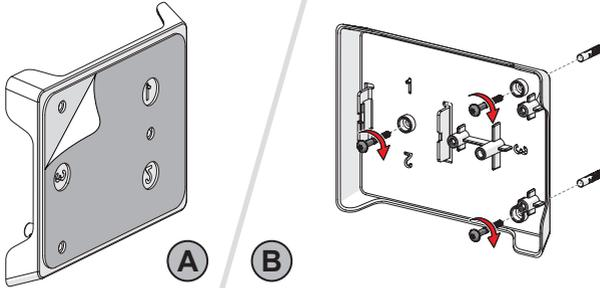

4

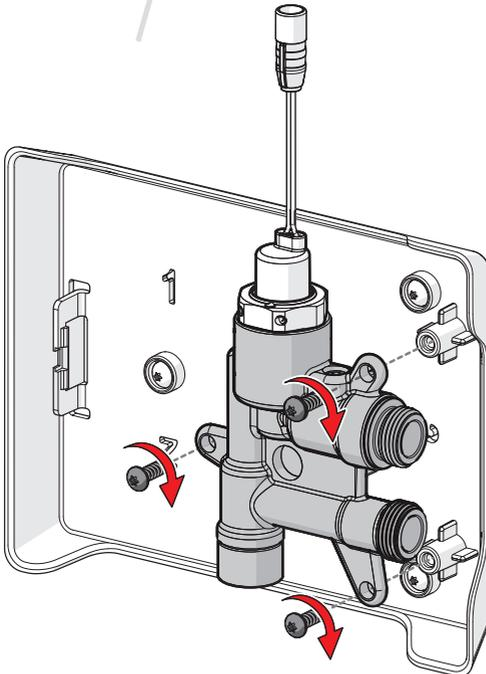

Installation

CZ Montáž
DE Montage
DK Installation
EE Paigaldus
ES Montaje

FI Asennus
FR Installation
IT Montaggio
LT Montavimas
LV Montāža

NL Installatie
NO Montering
PL Instalacja
RO Instalare
RU Установка

SE Installation
SK Inštalácia
UA Встановлення

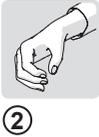
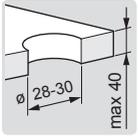

7

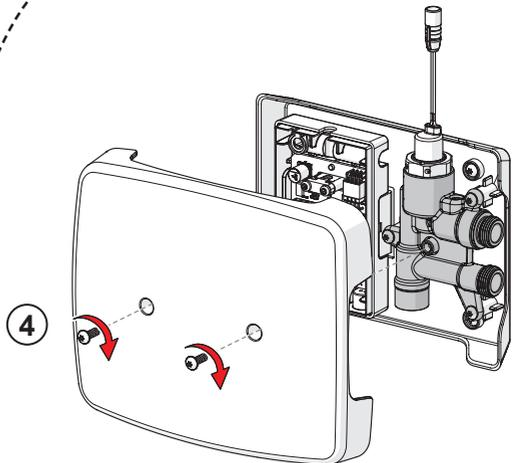
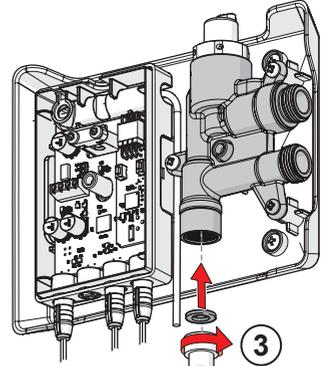
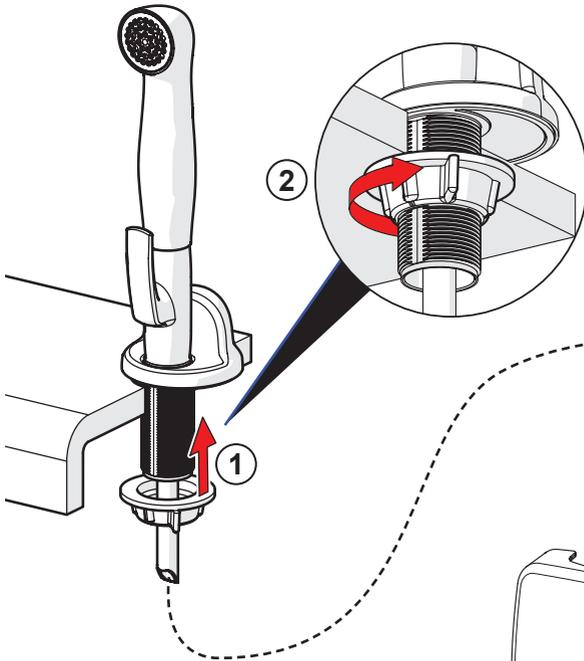

Operation

CZ Funkce
DE Funktion
DK Betjening
EE Toimimine
ES Servicio

FI Toiminta
FR Utilisation
IT Funzionamento
LT Veikimo principas
LV Darbības princips

NL Bediening
NO Funksjon
PL Działanie
RO Funcționare
RU Принцип действия

SE Funktion
SK Prevádzka
UA Принцип дії

1

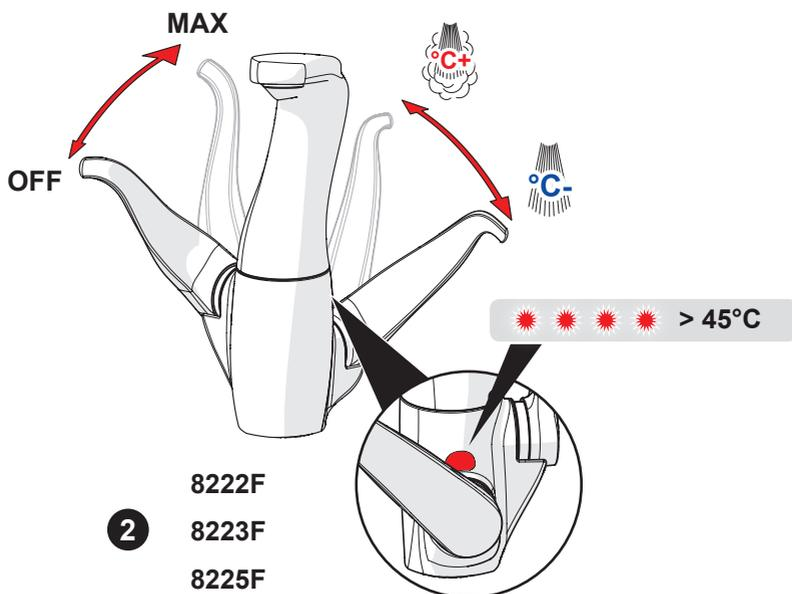

8222F

2

8223F

8225F

8227F

8222F

8223F

8225F

8227F

3

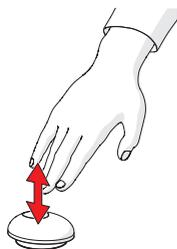

ON 60 s

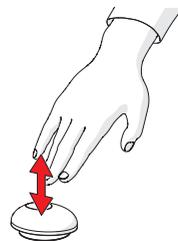
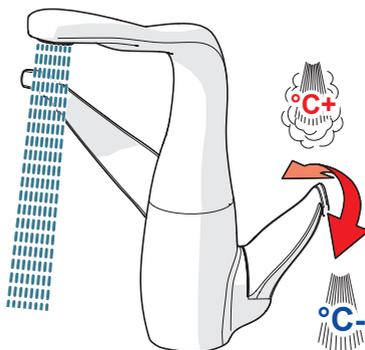

OFF

Operation

CZ Funkce

DE Funktion

DK Betjening

EE Toimimine

ES Servicio

FI Toiminta

FR Utilisation

IT Funzionamento

LT Veikimo principas

LV Darbības princips

NL Bediening

NO Funksjon

PL Działanie

RO Funcționare

RU Принцип действия

SE Funktion

SK Prevádzka

UA Принцип дії

4 8225F

8227F

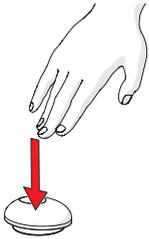

3 s

5 s

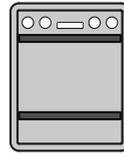
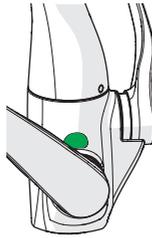

ON 4h

ON 12h

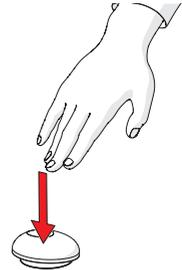

3 s OFF

5 8223F

8227F

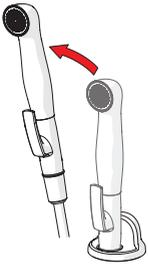

ON

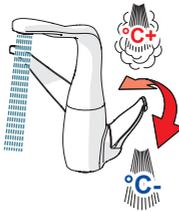

max. 2 min

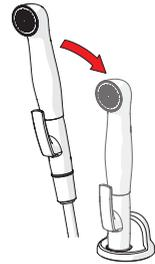

OFF

Changing the battery

CZ Výměna baterie

DE Wechsel der Batterie

DK Udskiftning af batteri

EE Patarei vahetamine

ES Cambiar la batería

FI Pariston vaihto

FR Changement de la pile

IT Sostituzione della batteria

LT Baterijos pakeitimas

LV Baterijas maiņa

NL Batterij vervangen

NO Bytting av batteri

PL Wymiana baterii zasilającej

RO Înlocuirea bateriei electrice

RU Замена батареек

SE Byte av batteri

SK Výmena batérie

UA Заміна батарейки



① ②

③

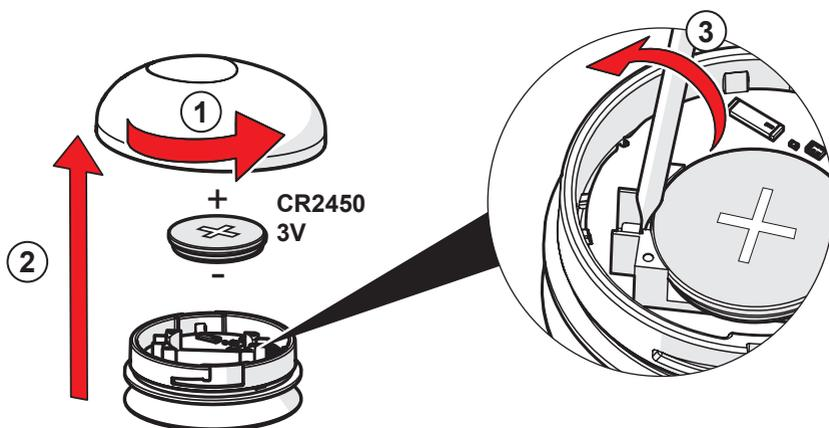
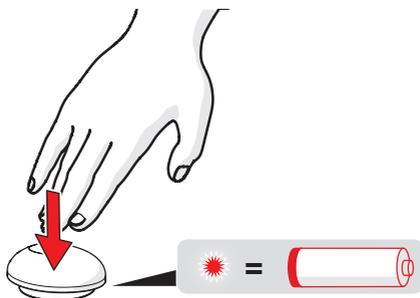

Changing the battery

CZ Výměna baterie
DE Wechsel der Batterie
DK Udskiftning af batteri
EE Patarei vahetamine
ES Cambiar la batería
FI Pariston vaihto
FR Changement de la pile
IT Sostituzione della batteria
LT Baterijos pakeitimas

LV Baterijas maiņa
NL Batterij vervangen
NO Bytting av batteri
PL Wymiana baterii zasilającej
RO Înlocuirea bateriei electrice
RU Замена батарейки
SE Byte av batteri
SK Výměna batérie
UA Заміна батарейки

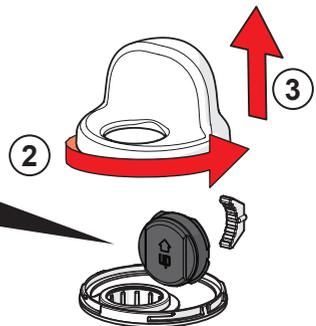
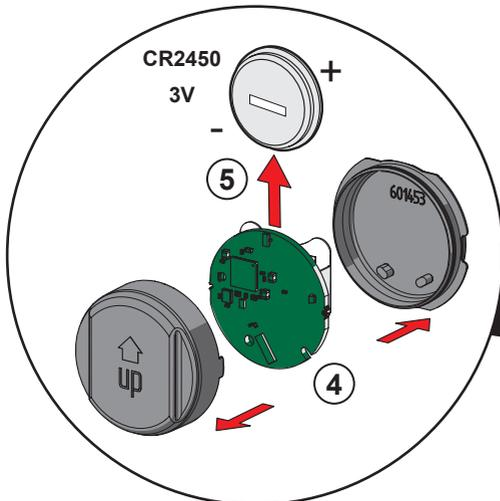
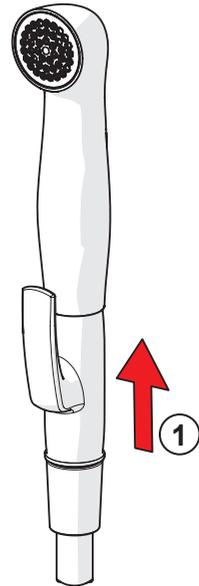
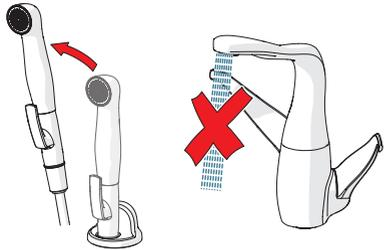

Changing the factory settings

CZ Změna hodnot předem nastavených výrobcem
DE Änderung der Werkseinstellungen
DK Ændring af fabriksindstillinger
EE Tehaseadete muutmine
ES Cambio de los ajustes de fábrica
FI Tehdasasetusten muuttaminen
FR Changement du réglage d'usine
IT Modifiche delle regolazioni di fabbrica
LT Gamyklinių nustatymų pakeitimas

LV Rūpnīcas iestatījumu maiņa
NL Wijziging factory settings
NO Forandring av fabrikkens forhåndsinnstillinger
PL Zmiana nastaw fabrycznych
RO Modificarea setărilor din fabrică
RU Изменение заводских значений
SE Justering av fabriksinställda styrparametrar
SK Zmena továrenských nastavení
UA Зміна заводських значень



① ②

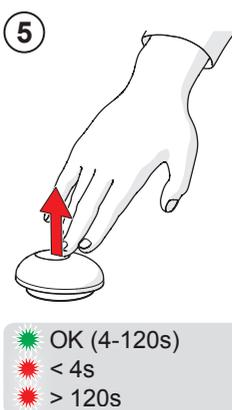
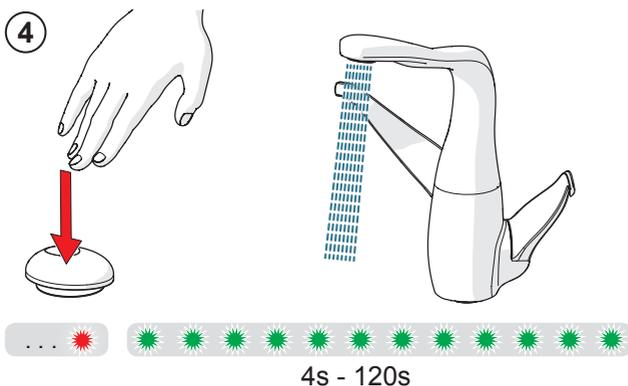
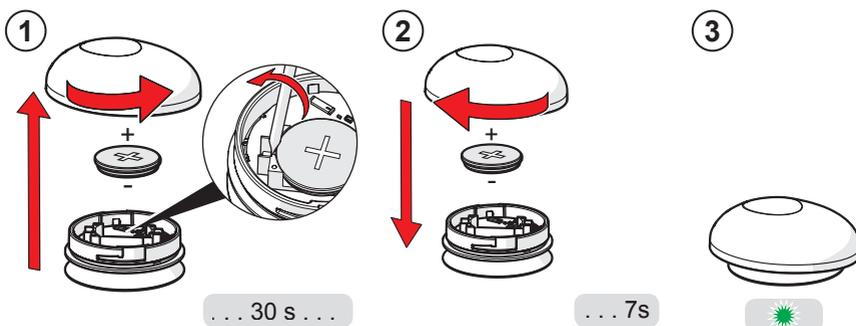

Changing the operating valve

CZ Výměna pracovního ventilu
DE Auswechseln der keramischen Oberteile
DK Udskiftning af topstykker
EE Seadeventiili vahetus
ES Recambio del cartucho del monoblock
FI Käyttöventtiilin vaihto
FR Changement de la tête ceramique eau chaude ou eau froide du grand bec
IT Sostituzione dei vitoni in ceramica
LT Vandens srauto reguliavimo ventilio pakeitimas

LV Ūdens plūsmas ventīļa maiņa
NL Vervangen van de werkingsklep
NO Bytting av overdel
PL Wymiana zaworu regulacyjnego
RO Înlocuirea ventilului de operare
RU Замена узла управления потоком воды
SE Byte av kranöverdel
SK Výměna prevádzkového ventilu
UA Заміна вузла управління потоком води

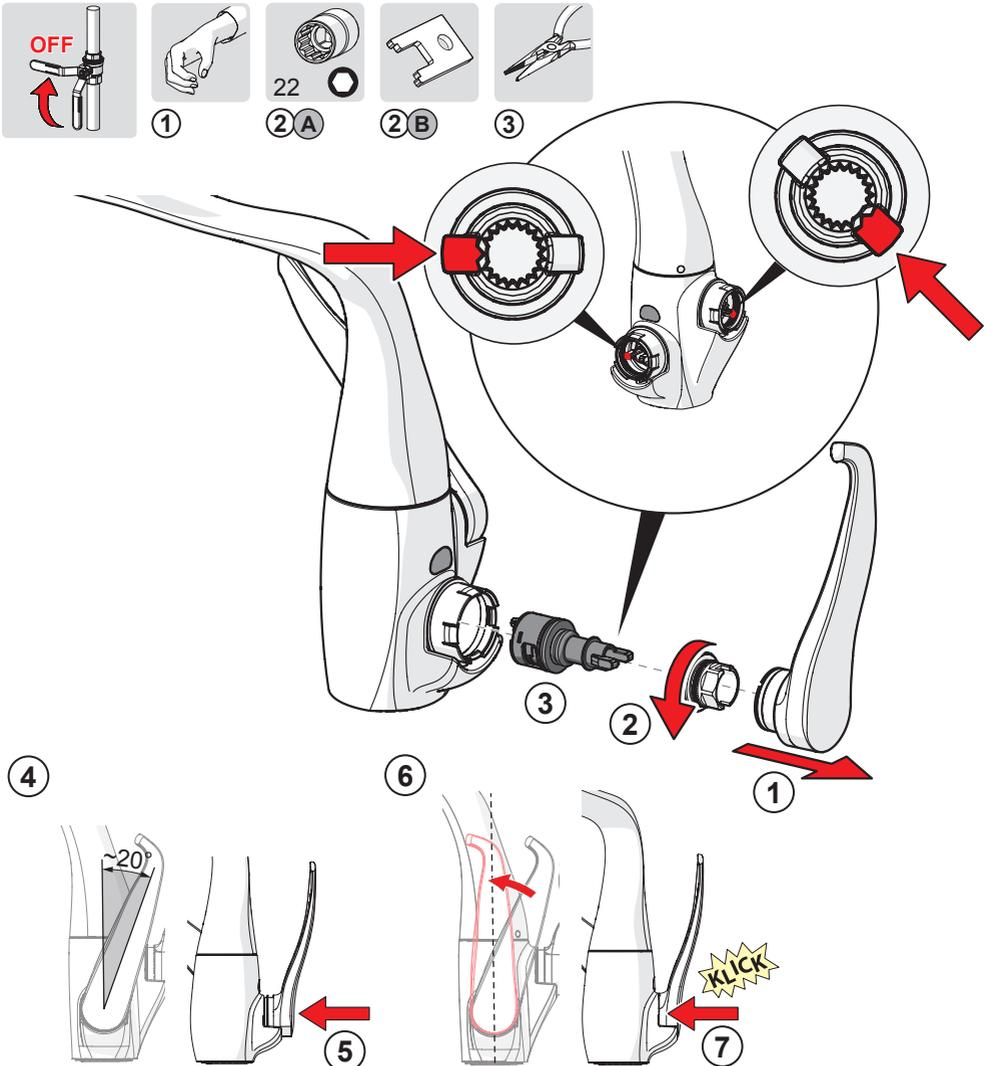

Cleaning/changing the litter filters

CZ Čištění/Výměna filtrů

DE Reinigung/Wechsel der Filter

DK Rensning/udskiftning af filtre

EE Prügipüüdurid puhastamine/vahetamine

ES Limpieza/cambio de los filtros

FI Roskasiivilöiden puhdistaminen/vaihtaminen

FR Nettoyage/changement des filtres

IT Pulizia/sostituzione dei filtri

LT Filtrų valymas ir pakeitimas

LV Dubļu filtru tīrīšana/maiņa

NL Reinigen/veranderen van de filters

NO Rensing/bytting av filter

PL Czyszczenie/wymiana filtra

RO Curățirea/inlocuirea filtrelor

RU Очистка и замена уплотнительных фильтров

SE Rengöring/byte av smutsfilter

SK Čistenie/výmena odpadových filtrov

UA Чищення та заміна ущільнюючих фільтрів

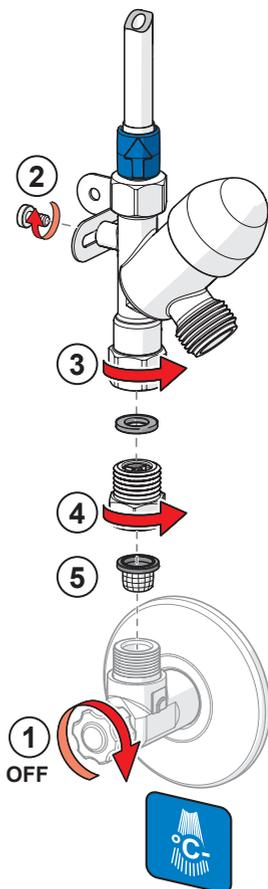
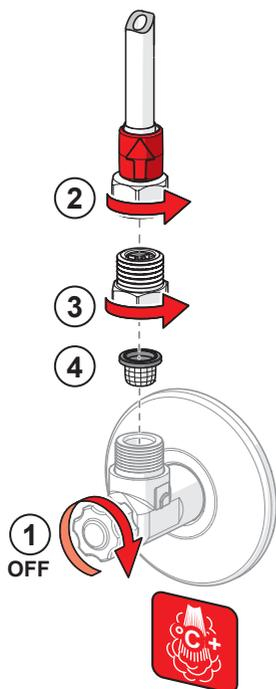
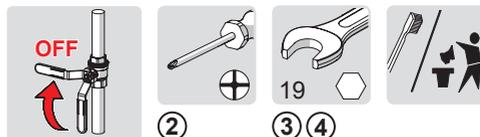
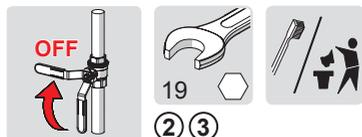

To change the spout's swing angle

CZ Výміна výtokového ramene

DE Den Schwenkbereich des Auslaufs ändern

DK Ændring af tudens svingradius

EE Jooksutoru pöördumisnurga muutmise

ES Variación del radio d'azione della bocca

FI Juoksutiputken kääntymiskulman muuttaminen

FR Changement de la rotation du bec

IT Per modificare l'angolo di rotazione della bocca

LT Snapelio posūtkio kampo pakeitimas

LV Iztekas pagrieziena leņķa maiņa

NL Om de draaihoek van de uitloop te wijzigen

NO Begrensning av tudens svingutslag

PL W celu zmiany kąta obrotu wylewki

RO Modificarea unghiului de rotație a pipei

RU Изменение угла поворота излива

SE Ändring av utloppspipens svängradie

SK Možnosť zmeny veľkosti úhlu otáčení výtokového ramene

UA Зміна кута повороту виливу



①



② ③

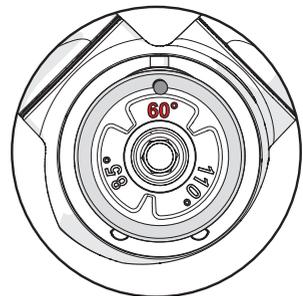
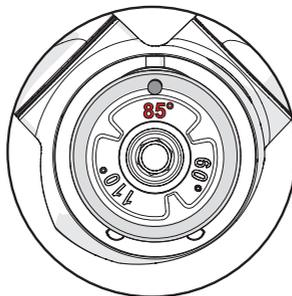
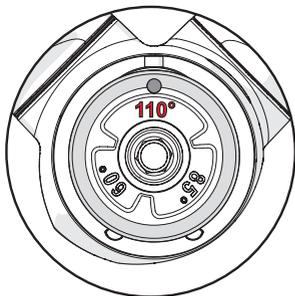
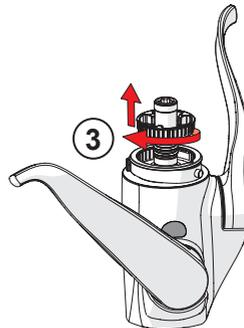
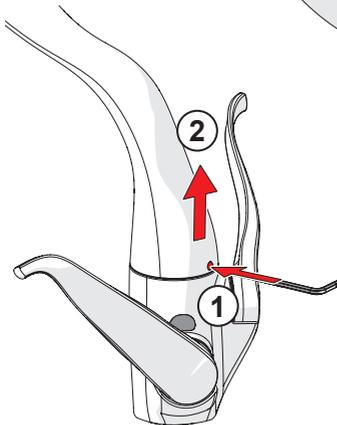
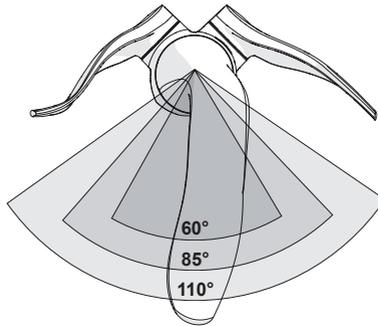

Changing the temperature sensor

CZ Výměna teplotního čidla

DE Austausch des Temperatursensors

DK Udskiftning af temperatursensor

EE Temperatuurianduri vahetamine

ES Cambio del sensor de temperatura

FI Lämpötila-anturin vaihto

FR Changement du capteur de température

IT Sostituzione del sensore di temperatura

LT Temperatūros jutiklio keitimas

LV Temperatūras sensora maiņa

NL Vervangen van de temperatuur sensor

NO Bytting av temperatur indikator

PL Wymiana czujnika temperatury

RO Înlocuirea senzorului de temperatură

RU Замена датчика температуры

SE Byte av temperaturgivare

SK Výměna snímača teploty

UA Замена датчика температури

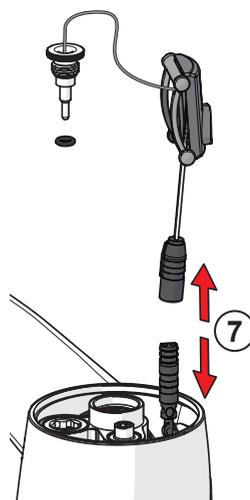
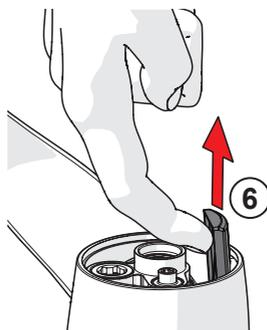
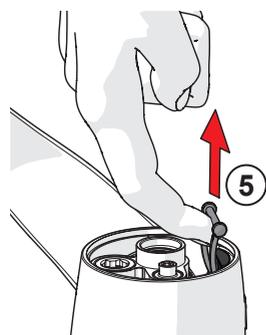
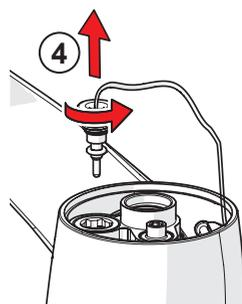
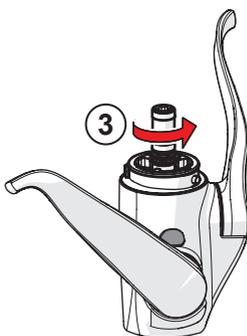
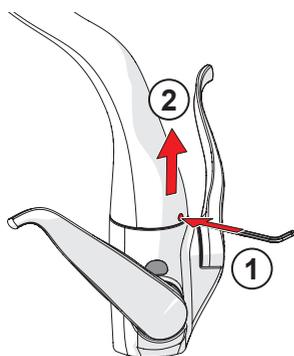

Servicing the solenoid valve

CZ Servis solenoidového ventilu

DE Wartung der Magnetventil

DK Rensning/udskiftning af magnetventilens

EE Magnetventiili vahetamine

ES Cambiar la válvula magnética

FI Magneettiventtiilin vaihto

FR Changement de l'électrovanne

IT Sostituzione della valvola magnetica

LT Elektromagnetinio vožtuvo pakeitimas

LV Elektromagnētiskā vārsta maiņa

NL Vervanging van de magneetventiel

NO Bytting av magnetventil

PL Wymiana zaworu solenoidowego

RO Întreținerea valvei solenoidale

RU Замена злектромагнитного клапана

SE Byte av magnetventil

SK Výmena elektromagnetického ventilu

UA Заміна електро магнітного клапана

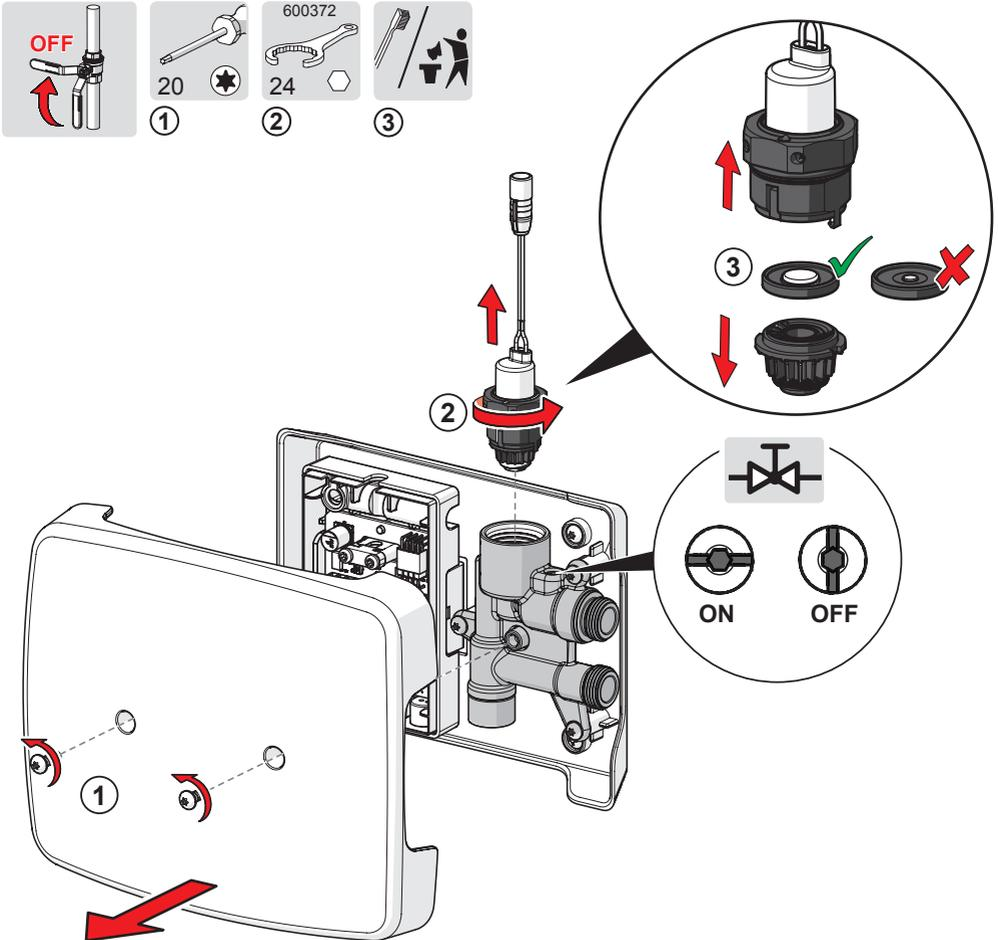

Cleaning the faucet

CZ Čištění baterie

DE Reinigung der Armatur

DK Rengøring af armaturet

EE Puhastamine

ES Limpieza de la grifería

FI Puhdistus

FR Nettoyage du robinet

IT Pulizia della rubinetteria

LT Maišytuvo valymas

LV Krāna tīrīšana

NL Reinigen van de kraan

NO Rengjøring av kranen

PL Czyszczenie baterii

RO Curățire

RU Чистка смесителя

SE Rengöring av blandarna

SK Čistenie vodovodnej batérie

UA Чищення змішувача

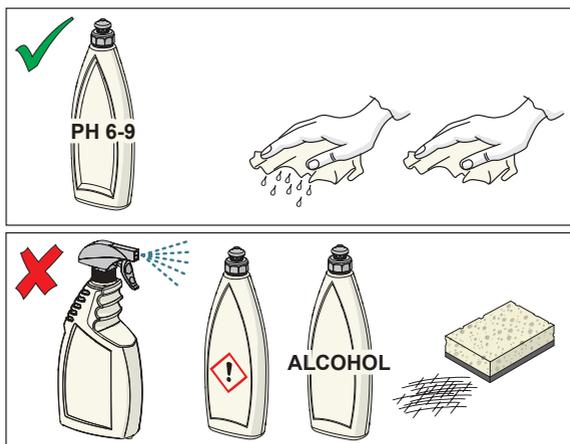
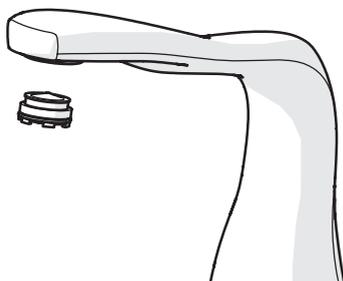
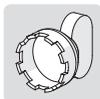

Spare parts

CZ Náhradní díly

DE Ersatzteile

DK Reservedele

EE Varuosad

ES Piezas de recambio

FI Varaosat

FR Pièces détachées

IT Pezzi di ricambio

LT Atsarginės dalys

LV Rezerves daļas

NL Reserve-
onderdelen

NO Reservedeler

PL Części zamienne

RO Piese de schimb

RU Запасные части

SE Reservdelar

SK Náhradné diely

UA Запасні частини

8220F

1 601287V

2 198287V

3 602547V

4 1001155V

5 602560V

6 602557V

7 602558V

8 602573V

9 158825

10 600705/10

11 198473/2

12 199257/2

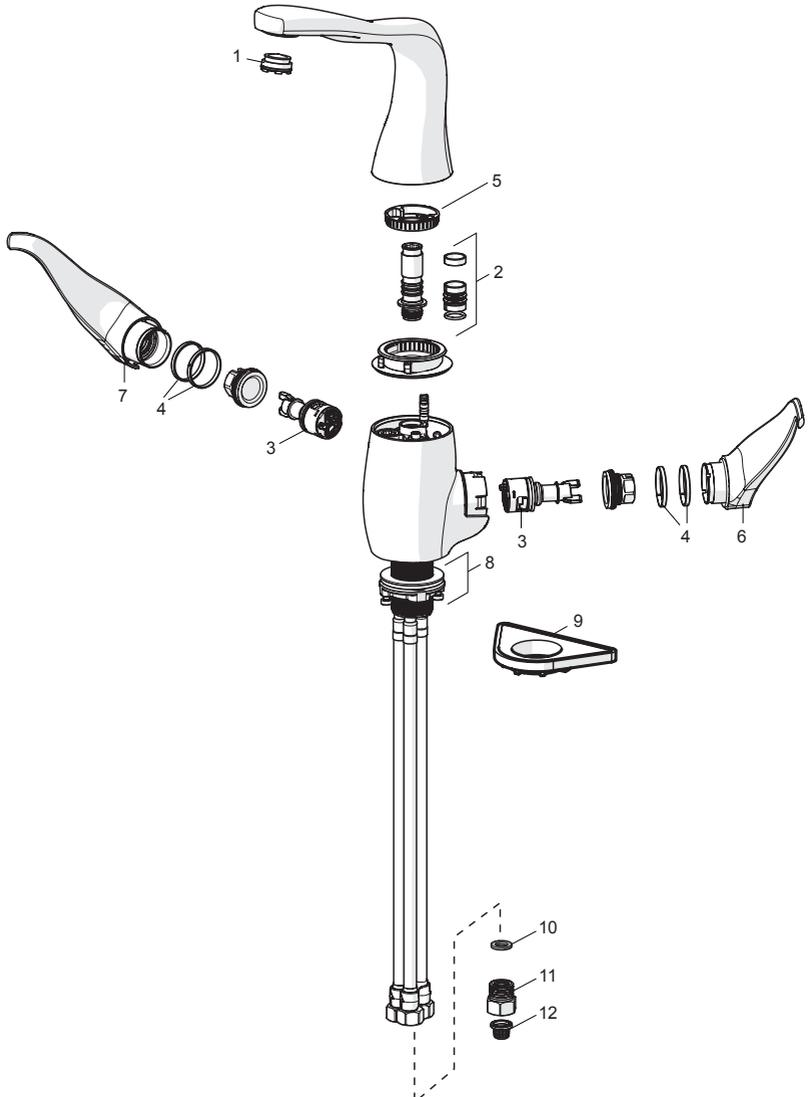

Spare parts

CZ Náhradní díly
DE Ersatzteile
DK Reservedele
EE Varuosad
ES Piezas de recambio

FI Varaosat
FR Pièces détachées
IT Pezzi di ricambio
LT Atsarginės dalys
LV Rezerves daļas

NL Reserve-
 onderdelen
NO Reservedeler
PL Części zamienne
RO Piese de schimb

RU Запасные части
SE Reservdelar
SK Náhradné diely
UA Запасні частини

8222F, 8223F, 8225F, 8227F

- 1 601287V
- 2 198287V
- 3 1001729V
- 4 602547V
- 5 1001155V
- 6 601884V-F
- 7 601512V
- 8 1002071V
- 9 602560V
- 10 602557V
- 11 602558V
- 12 602573V
- 13 158825
- 14 600705/10
- 15 198473/2
- 16 199257/2
- 17 601468V

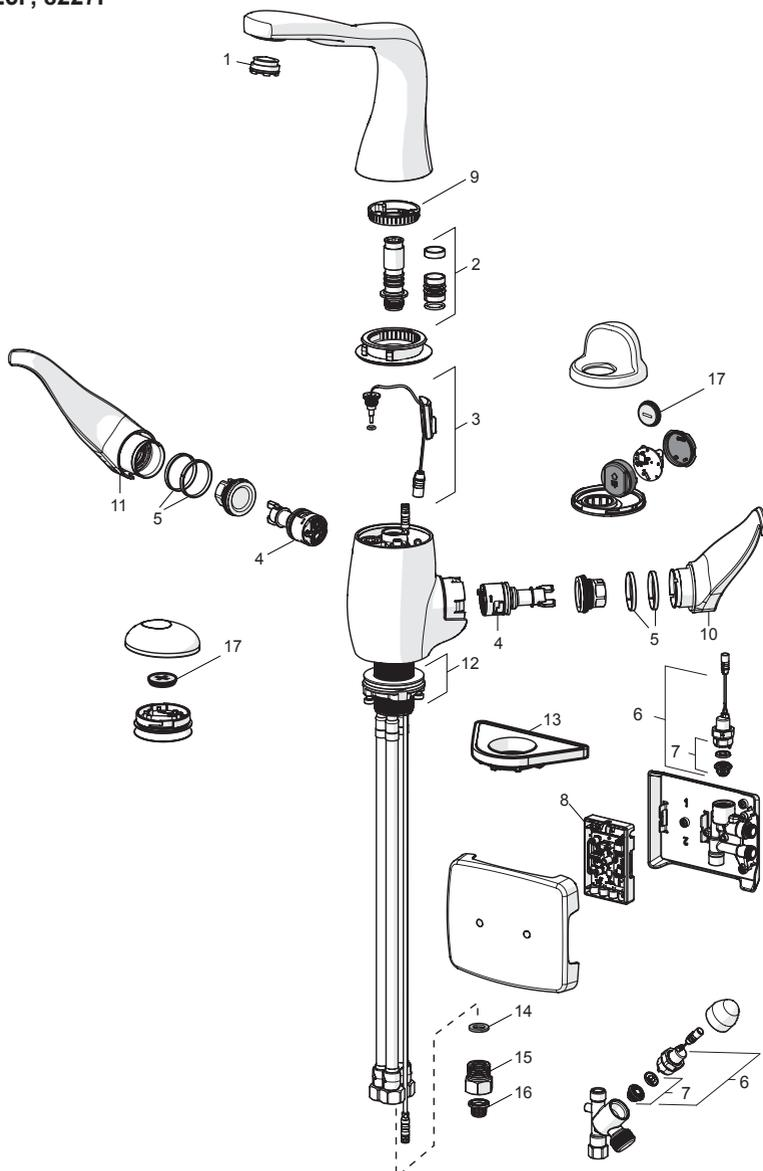

Oras Group is a powerful European provider of sanitary fittings: the market leader in the Nordics and a leading company in Continental Europe. The company's mission is to make the use of water easy and sustainable and its vision is to become the European leader of advanced sanitary fittings. Oras Group has two strong brands, Oras and Hansa.

The head office of the Group is located in Rauma, Finland, and the Group has four manufacturing sites: Burglengenfeld (Germany), Kralovice (Czech Republic), Olesno (Poland) and Rauma (Finland). Oras Group employs approximately 1400 people in twenty countries. Oras Group is owned by Oras Invest, a family company and an industrial owner.

ORAS GROUP
Isometsäntie 2, P.O. Box 40
FI-26101 Rauma
Tel. +358 2 83 161
Fax +358 2 831 6300
info.finland@oras.com
www.oras.com

