

Hantering av glasprodukter ska alltid ske med omsorg och försiktighet.

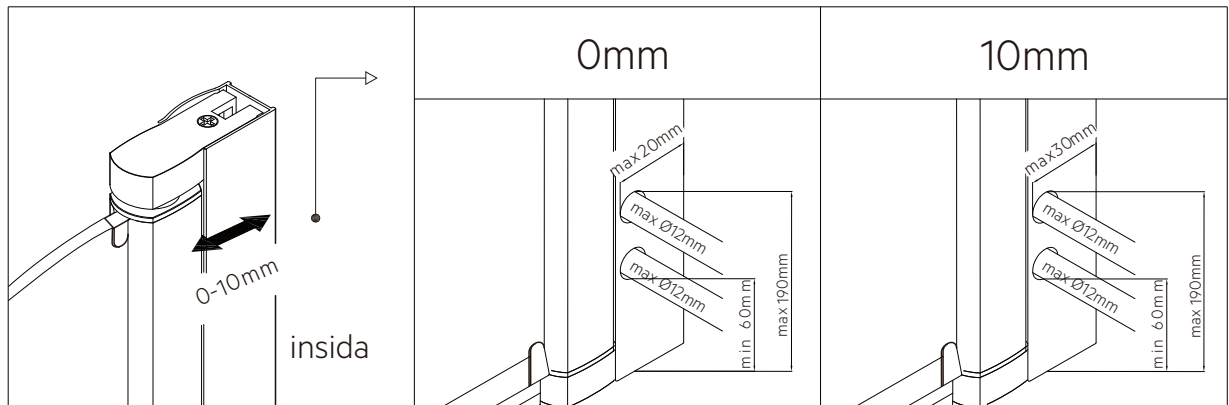

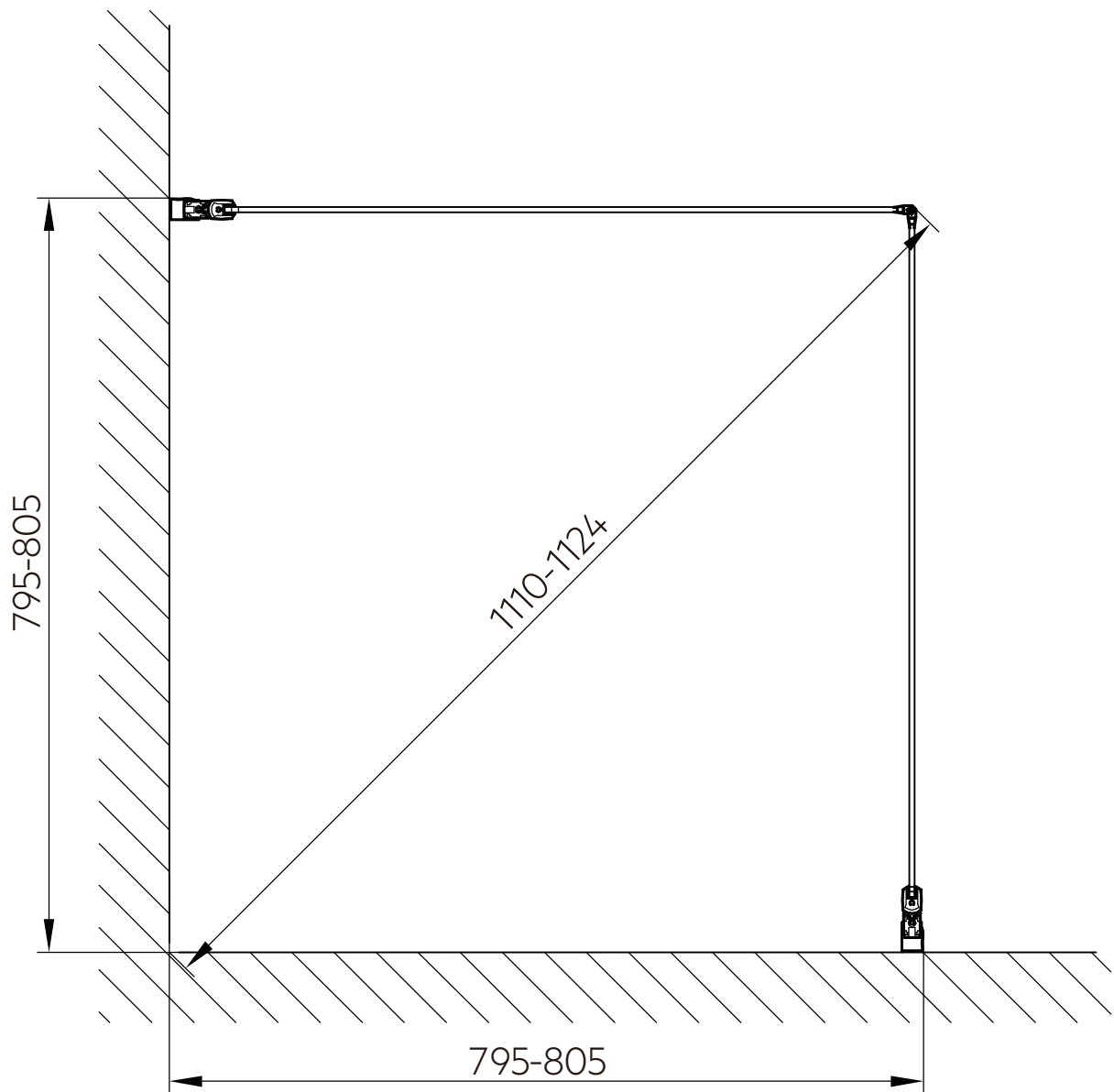

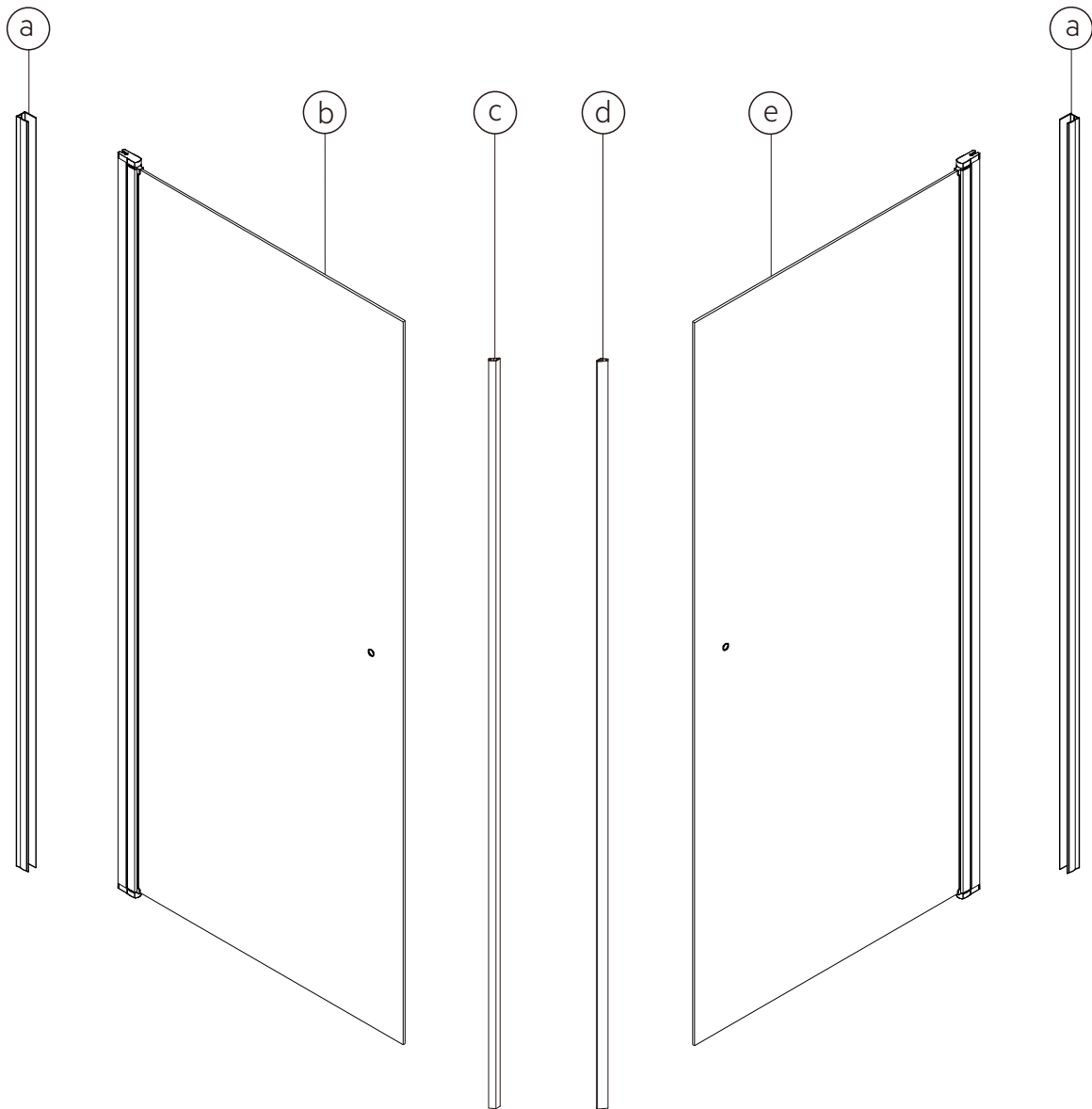
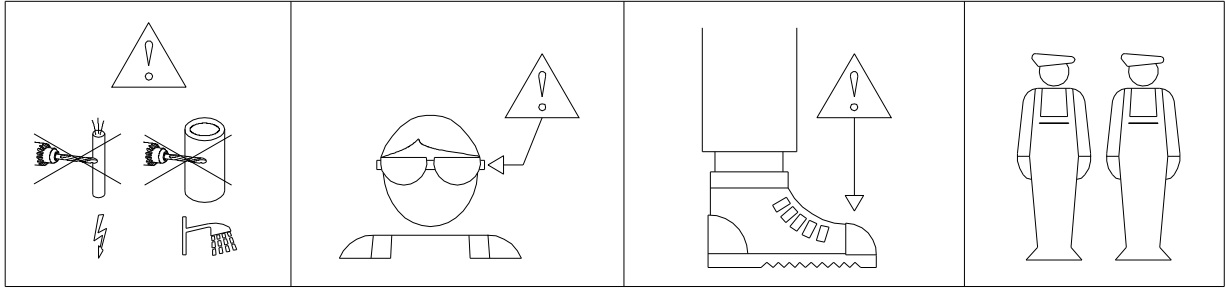
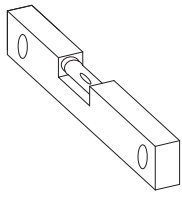

(A)

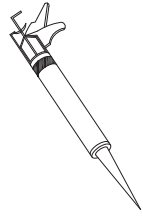

(B)

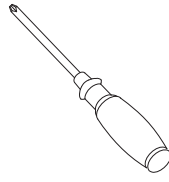

(C)

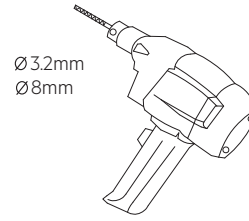

(D)

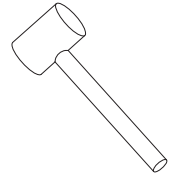

(E)



(F)



(G)



(H)

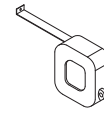

(I)

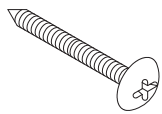

10x (Ø 5x40mm)

(1)



10 x (Ø 4x12mm)

(2)

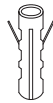

10 x (Ø 8x40mm)

(3)

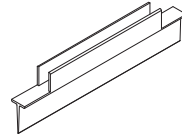

2 x

(4)

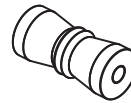

2 x

(5)



1 x

(6)



10 x

(7)



10 x

(8)



10 x

(9)

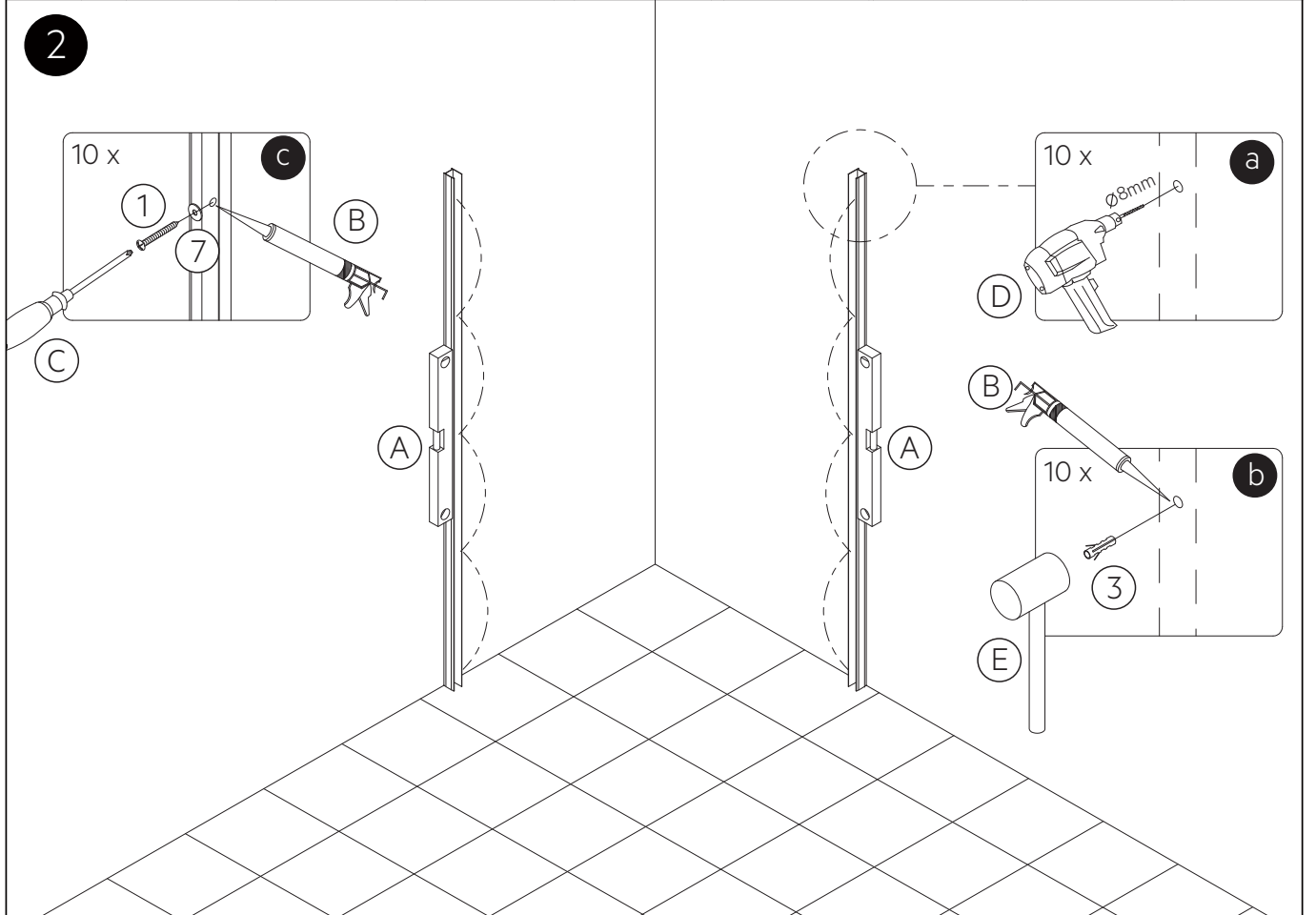
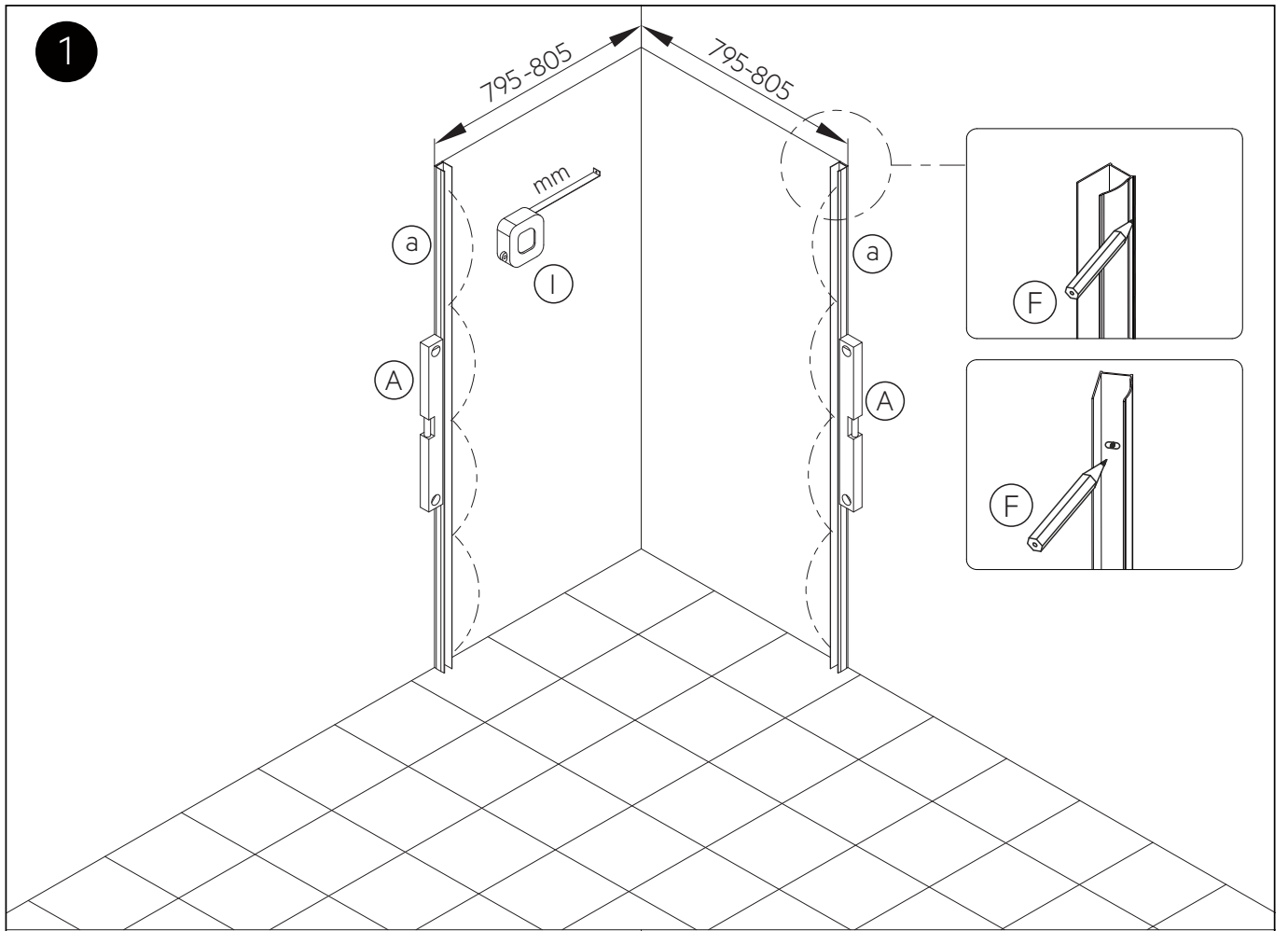

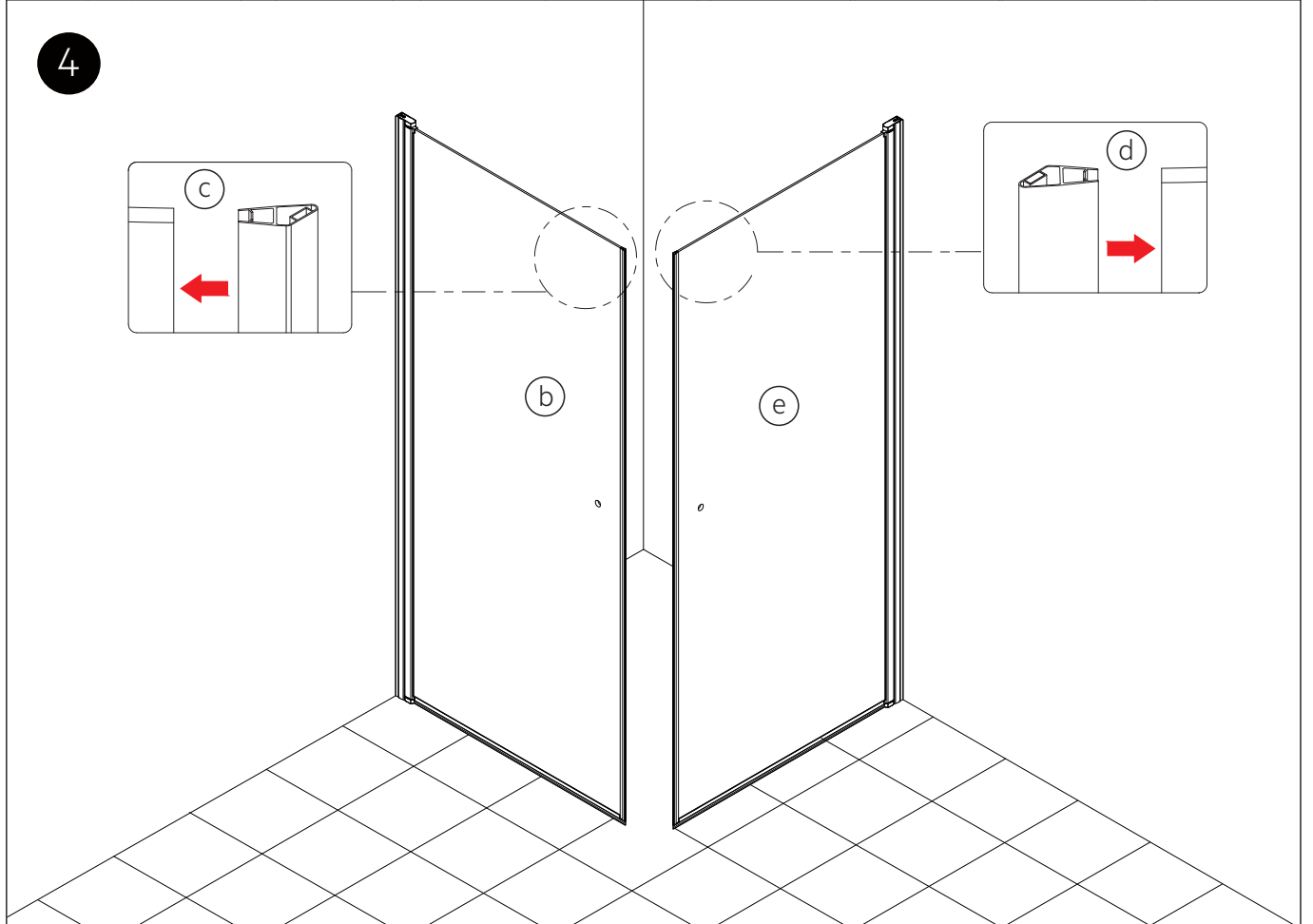
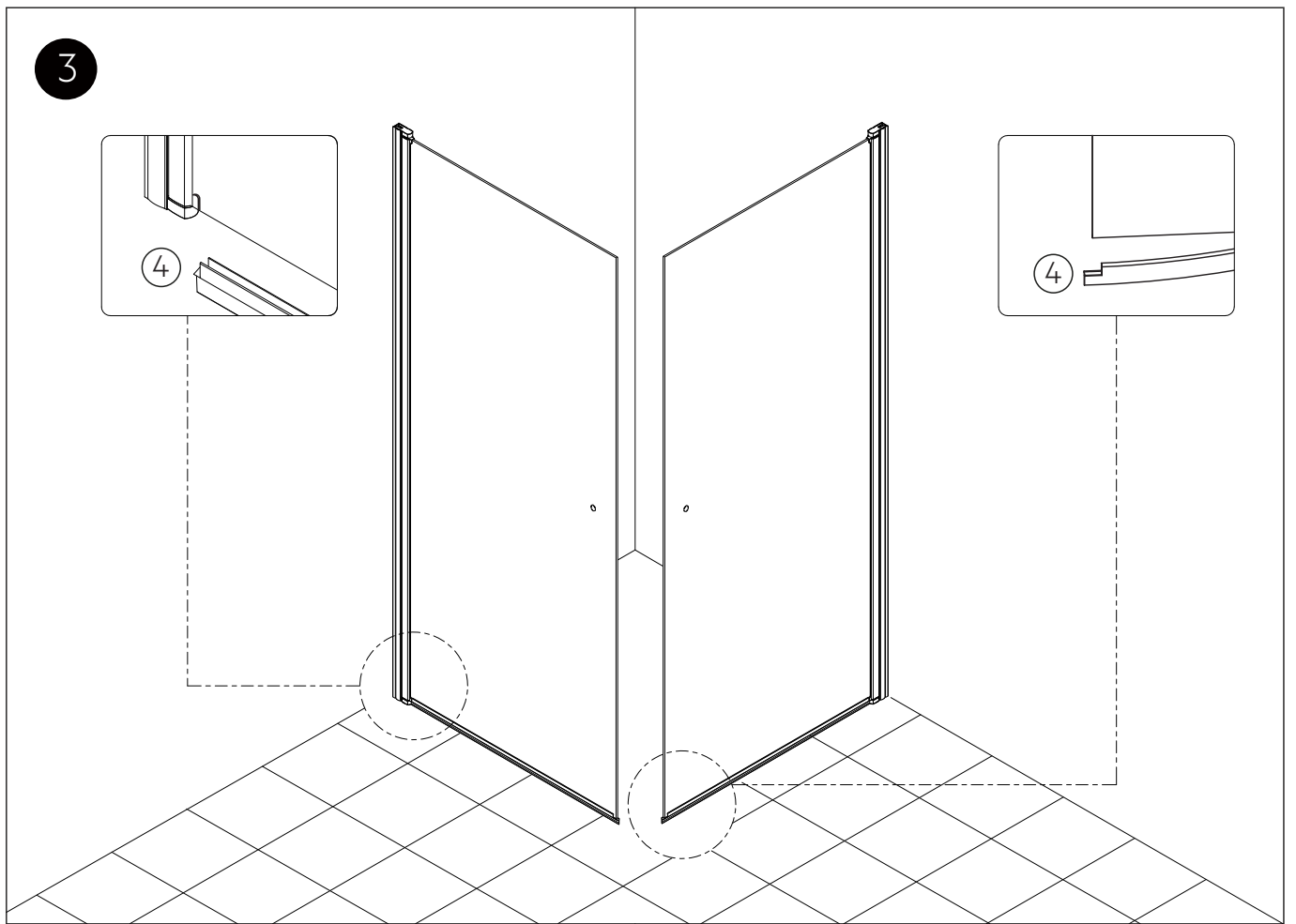

5

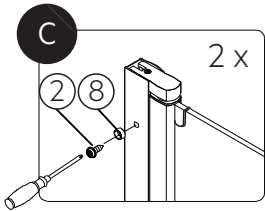
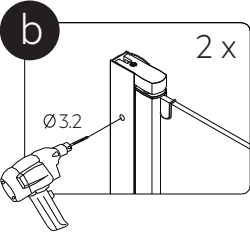
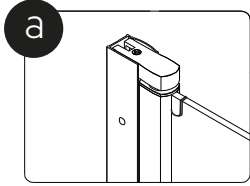

Tighten the top screw fully, then loosen it by 2 rotations.

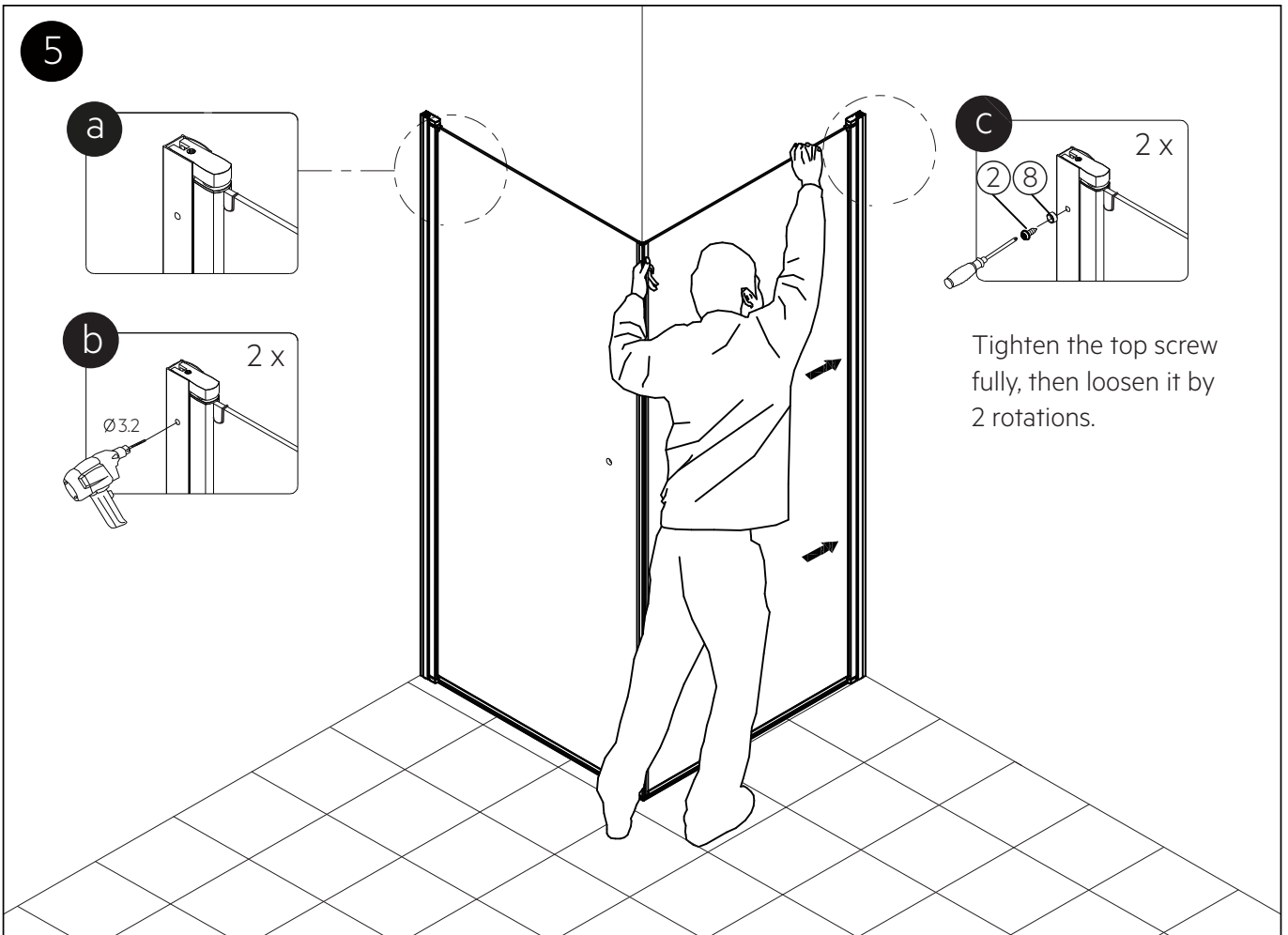

6

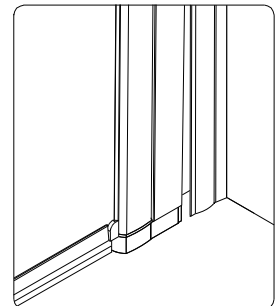
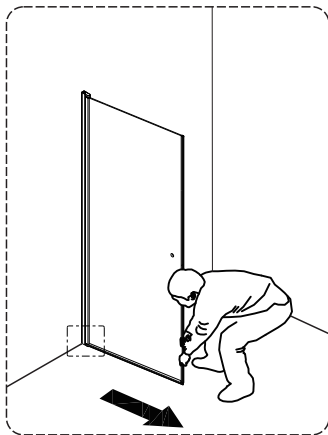

Adjust the glass by pulling/pushing the door so that it is straight leveled to the floor.

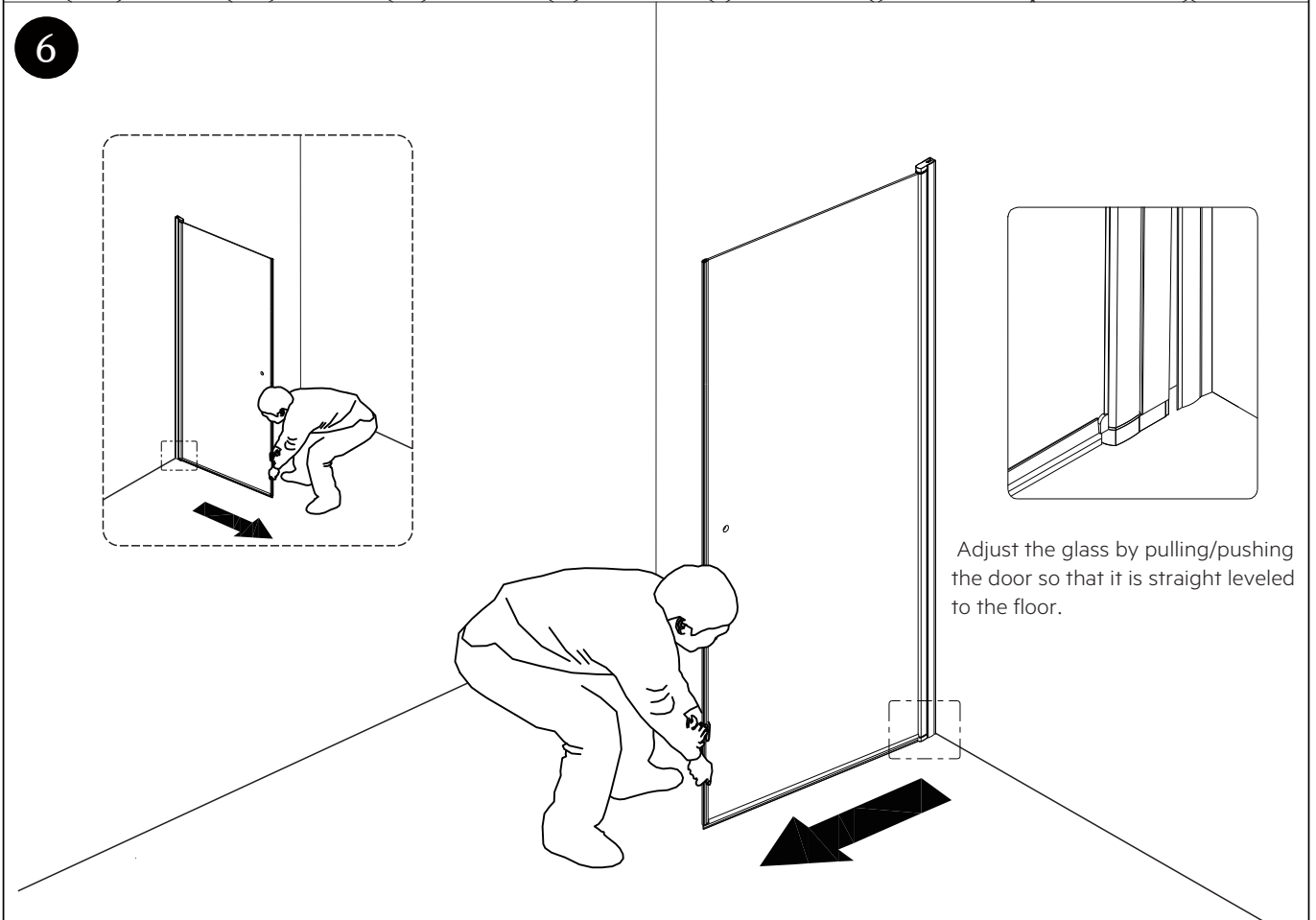

7

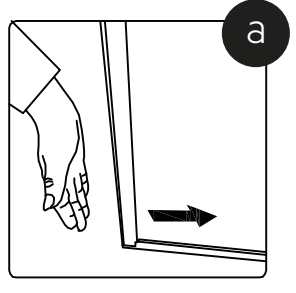
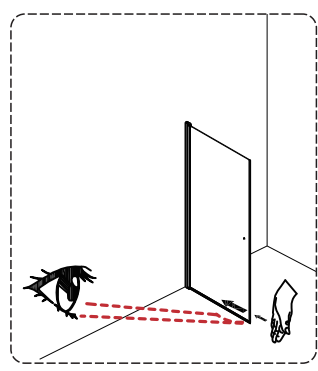

Gently tap the lower part of the glass from the side. Slowly push the door into the aluminum frame against the wall. Stop when the bottom waterproof strip reaches the "OK" position as shown in the drawing.

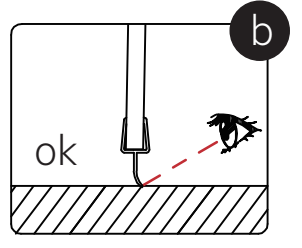
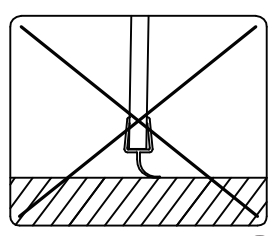
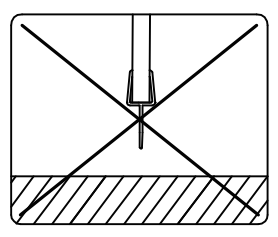
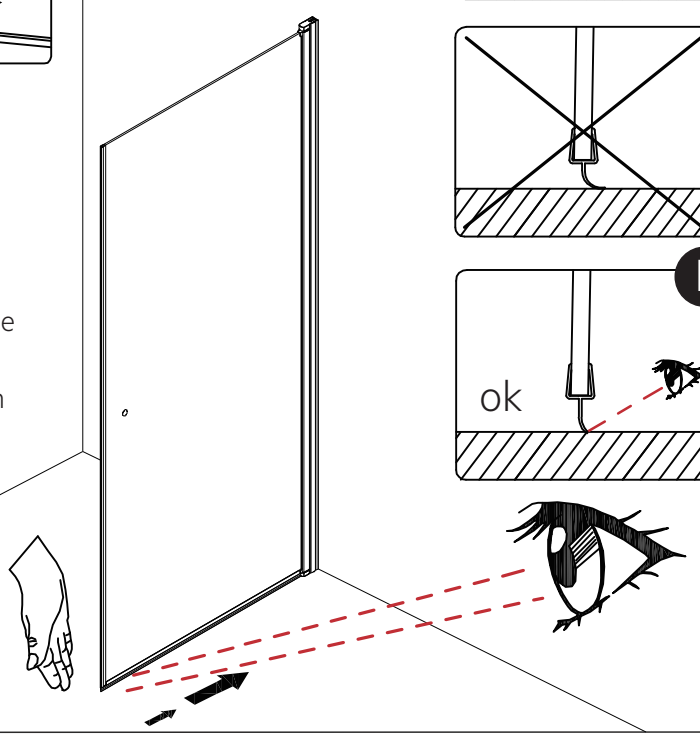

8

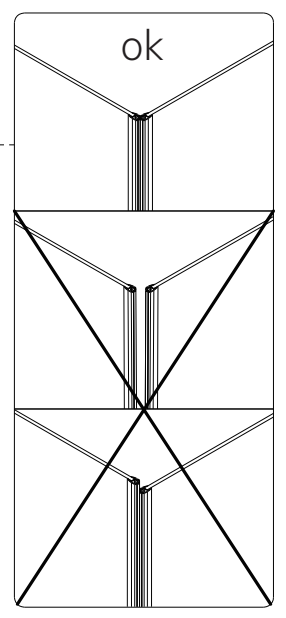
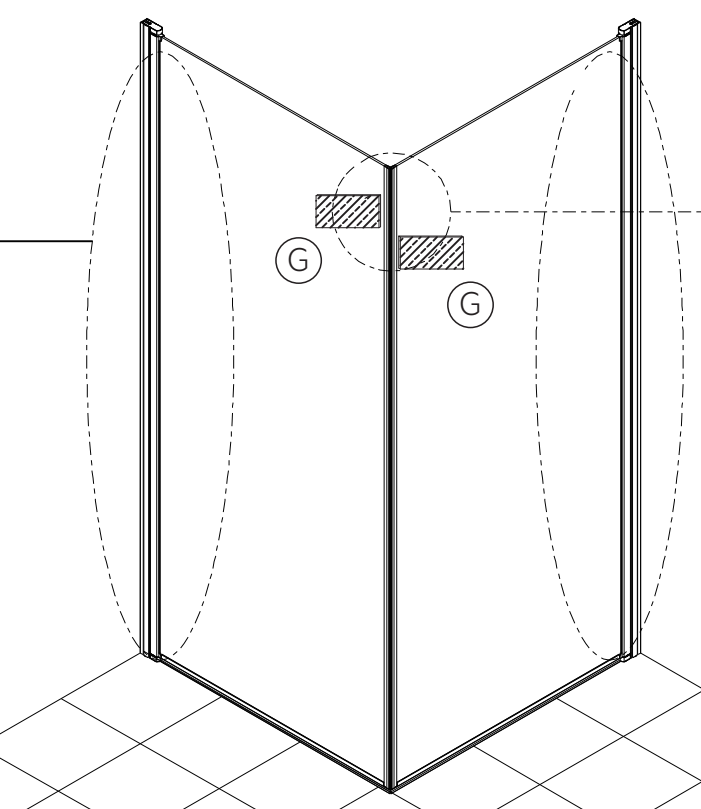
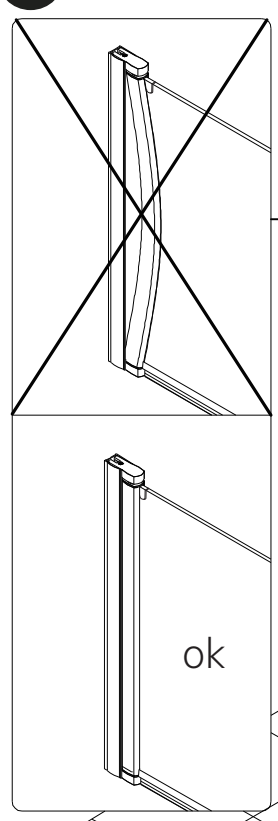

9

Dra åt skruvarna när dörarna är i stängt läge, annars fungerar inte höjning/sänkningsfunktioner.

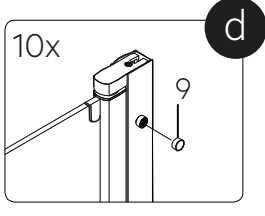
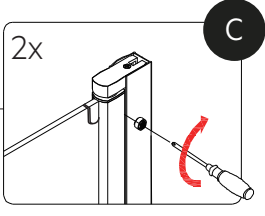
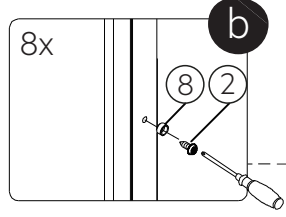
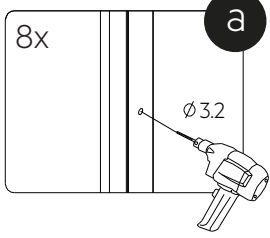

10

