

Uponor Ecoflex rubber end cap

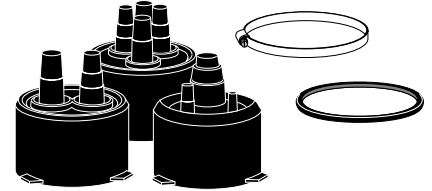

020000212

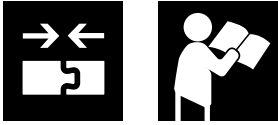
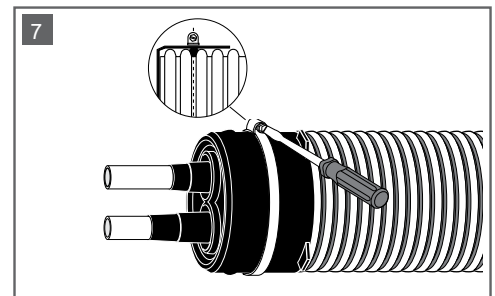
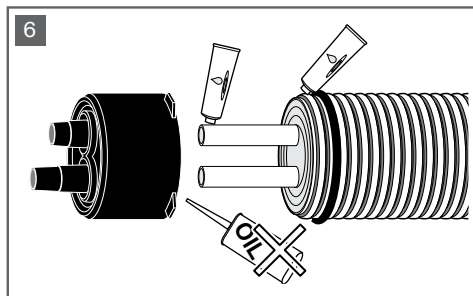
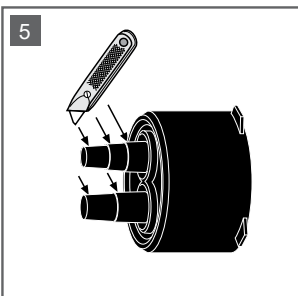
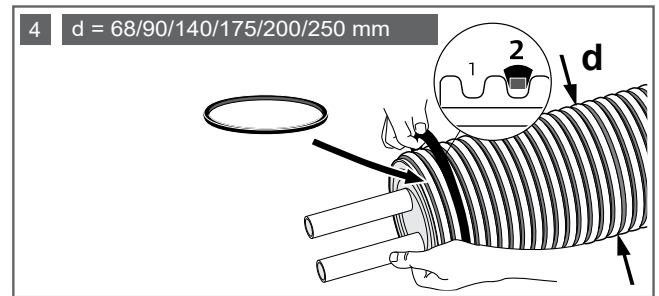
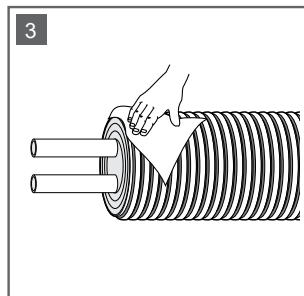
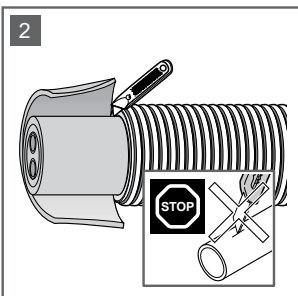
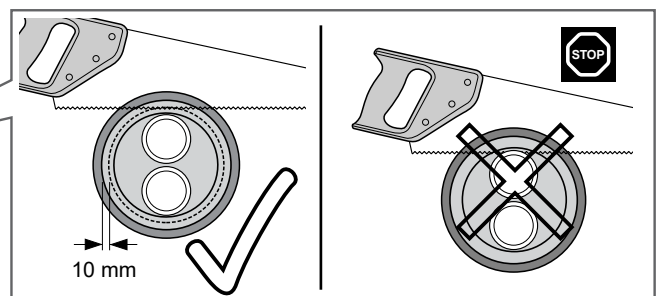
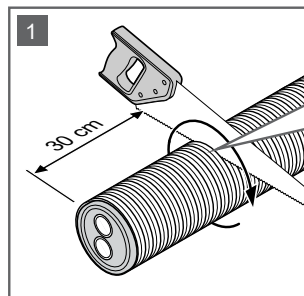
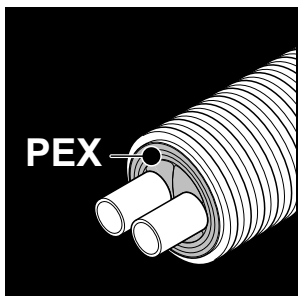

Uponor Ecoflex rubber end cap
Quattro 18-28+32+40/200



1034308

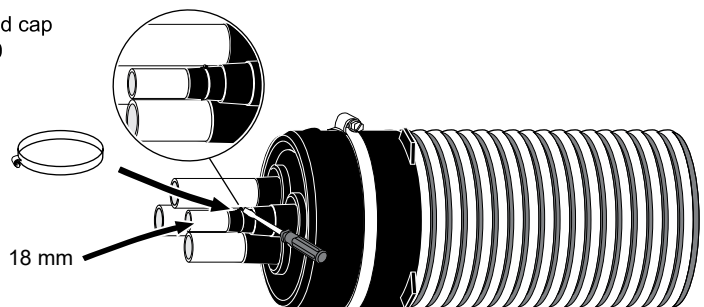

5/20/01233

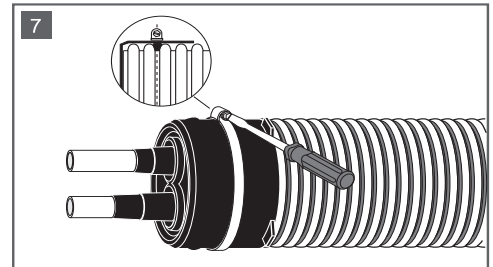
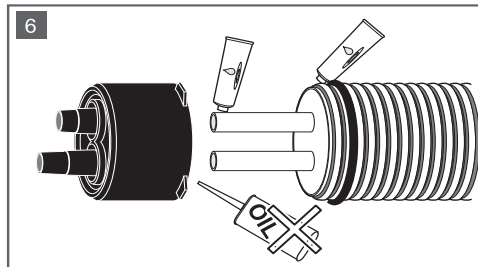
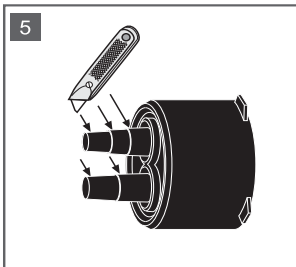
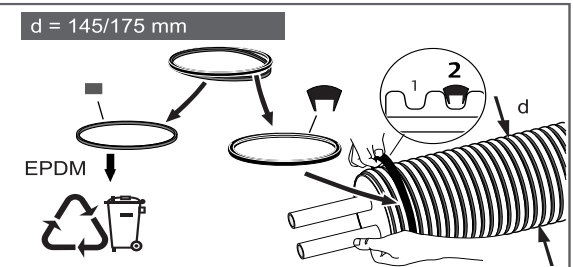
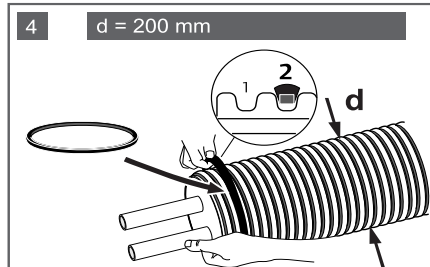
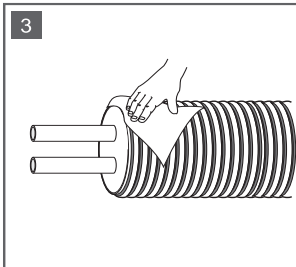
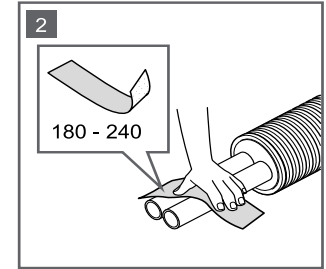
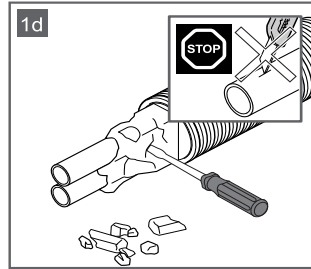
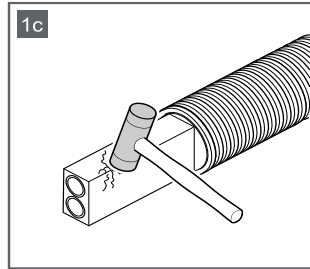
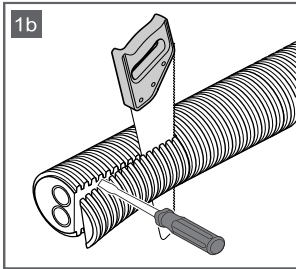
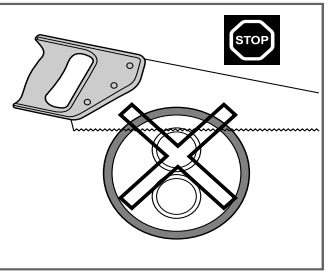
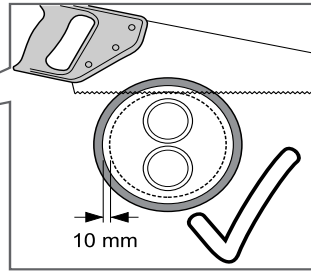
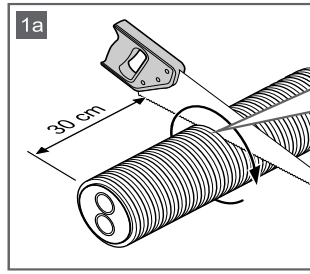
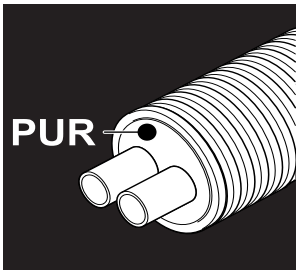

Uponor Ecoflex H-insulation set
200/175/145/140

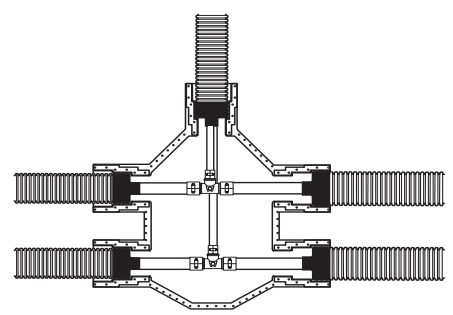
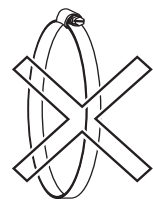
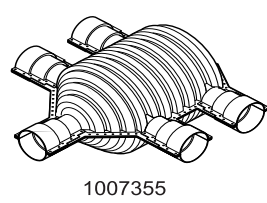

00200005

Uponor GmbH
Industriestraße 56,
D-97437 Hassfurt, Germany

1022116 07_2019_INT
Production: Uponor/ELO

Uponor reserves the right to make changes, without prior notification,
to the specification of incorporated components in line with its policy of
continuous improvement and development.



www.uponor.com