

Installation Guide

Danfoss Link™ Gateway (DLG) (code no. 087H3241) ECL Comfort 110 Danfoss Link™

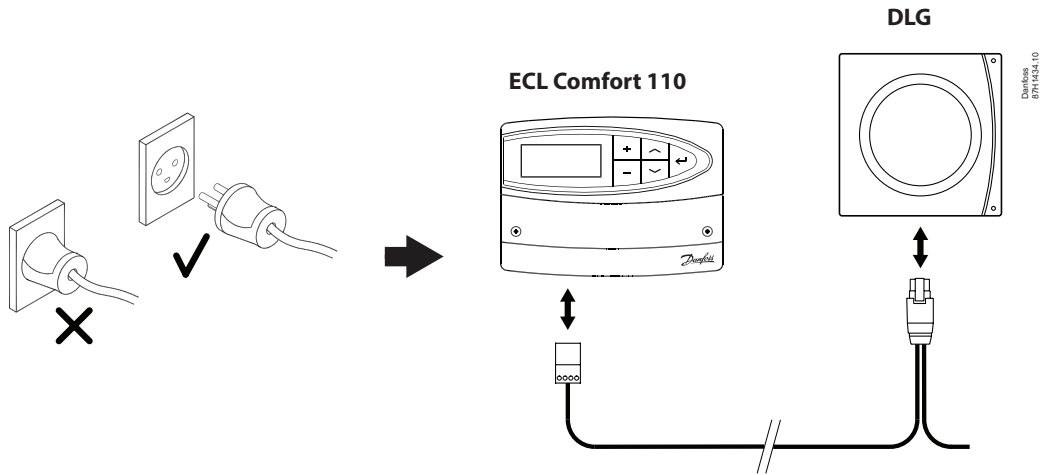

Application example · Applikationseksempel · Applikationexempel · Applikationsbeispiel

ECL Comfort 110, DLG, Danfoss Link™ CC

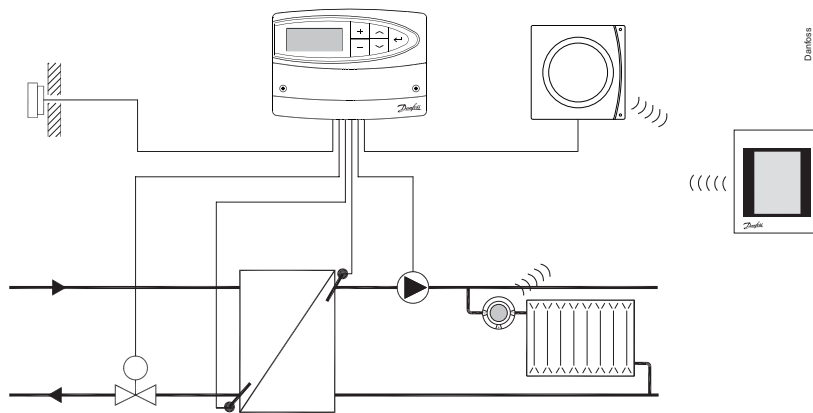

ECL 110
Danfoss Link™ Gateway
Danfoss Link™ CC
Danfoss Living Connect®

<http://heating.danfoss.com>
<http://heating.danfoss.com>
<http://heating.danfoss.com>
<http://homeowners.danfoss.com/products/smartheating/#/>

Mounting · Montering · Montering · Befestigung
DLG

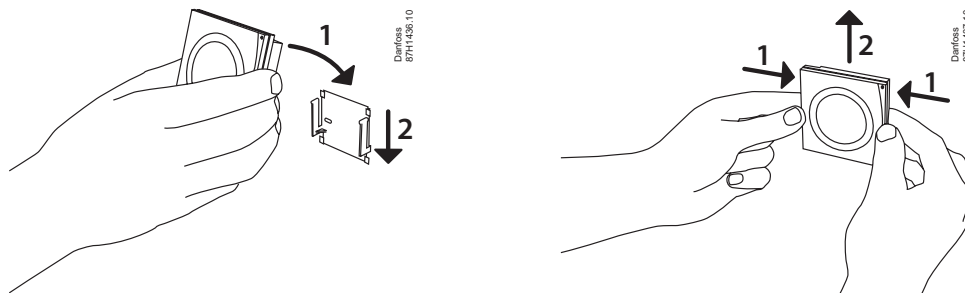

ECL Comfort 110, DLG, Danfoss Link™ CC

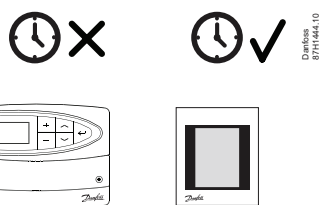
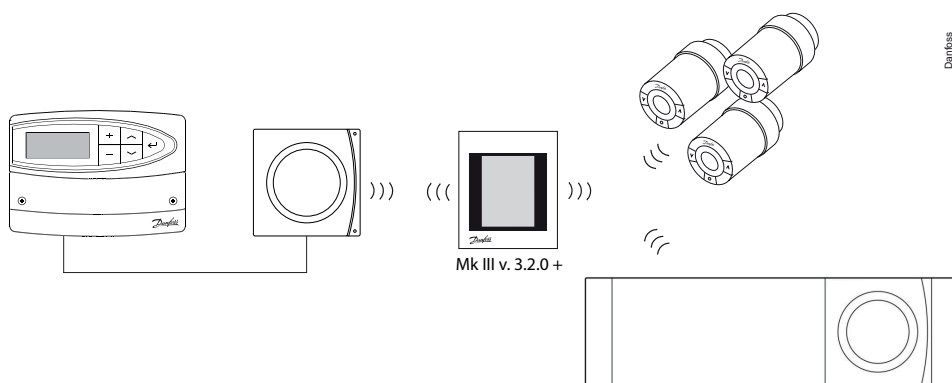

ECL 110	?	http://heating.danfoss.com	Documentation	VIKTG
Danfoss Link™ CC	?	http://heating.danfoss.com	Documentation	VISGL
Danfoss Living Connect®	?	http://heating.danfoss.com	Documentation	VIIDH

Electrical connection · El-tilslutning · Elektrisk anslutning · Elektrischer Anschluss
ECL Comfort 110

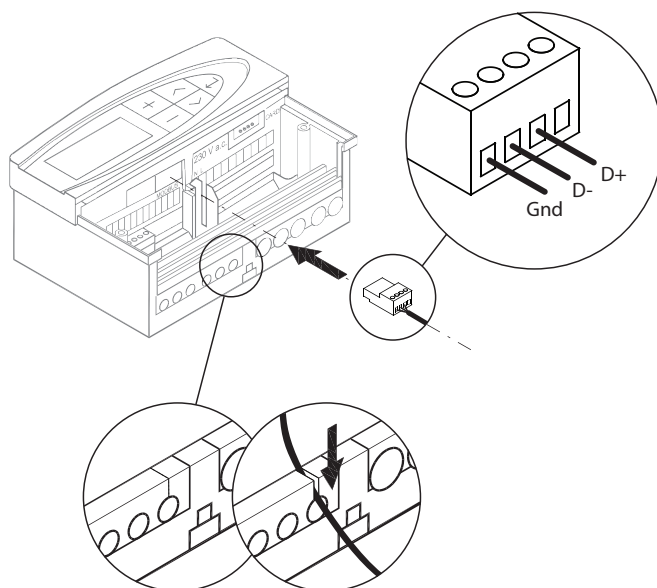

Danfoss
87H1439.10

<http://heating.danfoss.com>
Documentation
VIKTG

DLG

Data / Daten	
DLG	8 - 24 V d.c.
	220 - 240 V a.c., 50 Hz
	0,9 W
	0 - 45° C
	868,42 MHz
	0 - 30 m
	Max. 1 mW
IP class	20
Dim.	80 x 80 x 30 mm

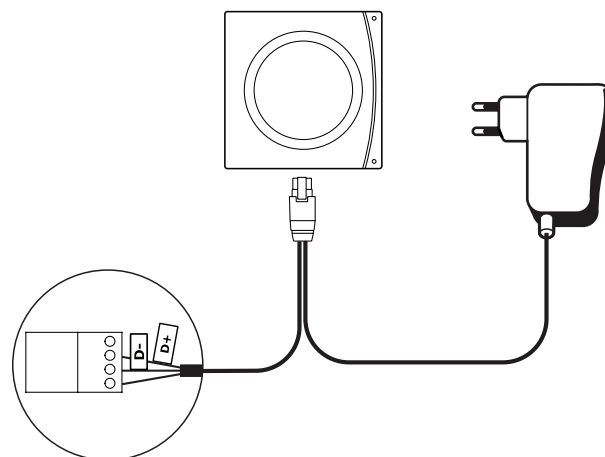

Danfoss
87H1445.10

Adding DLG / ECL 110 · Tilmelding af DLG / ECL 110 · Lägga till DLG / ECL 110 · DLG / ECL 110 hinzufügen

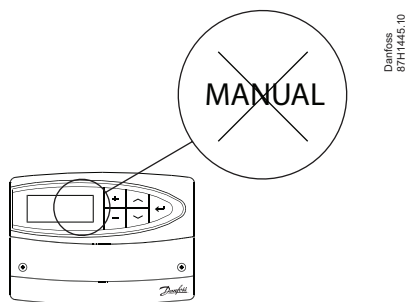
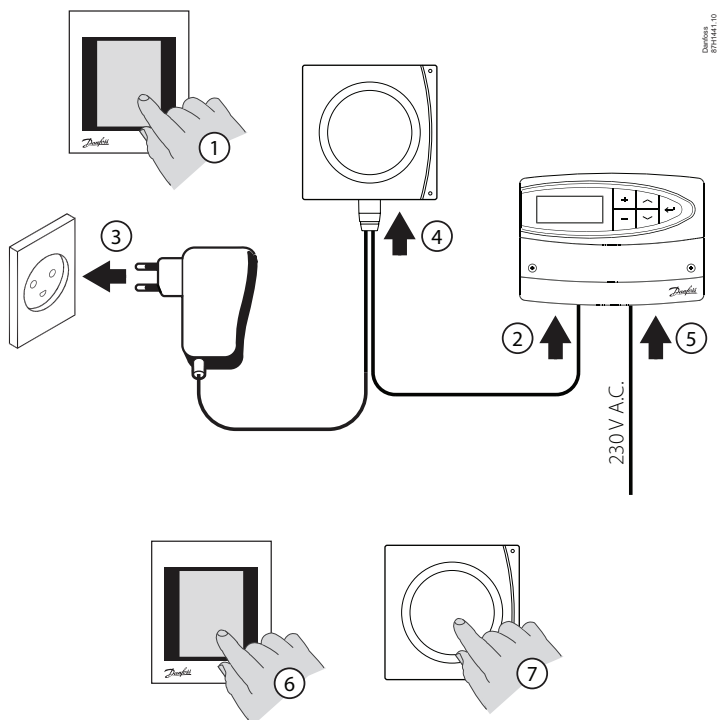

Disconnecting DLG from CC · Afbryde DLG fra CC · Koppla DLG från CC · DLG von CC abschalten

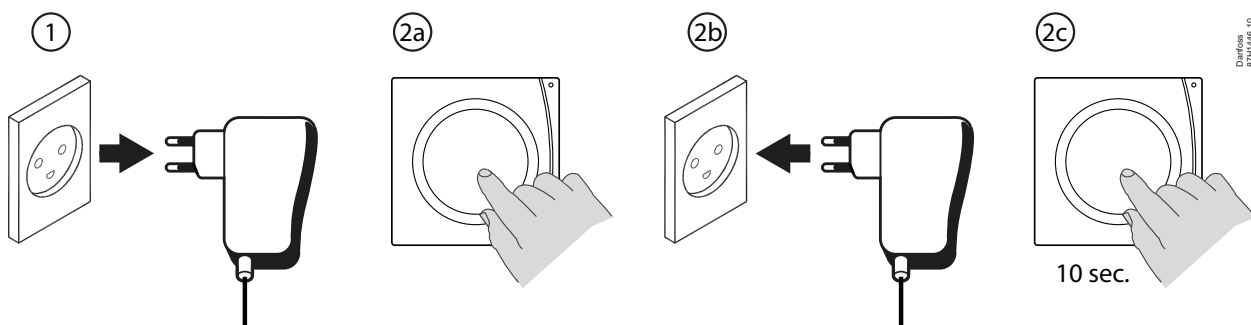

Adding DLG / ECL 110

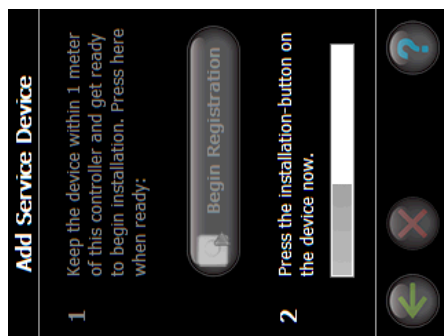

6

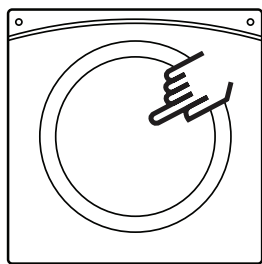

7



8



9

Tilmelding af DLG / ECL 110

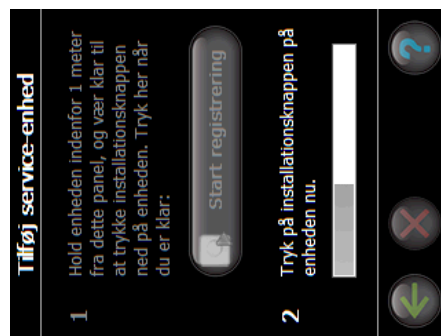

6

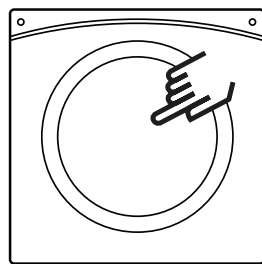

7



8



9

Lägga till DLG / ECL 110

Lägg till serviceenhet

- 1 Placera enheten inom 1 meter från den här kontrollenheten och förbered installationen. Klicka här när du är klar:
- 2 Tryck på installationsknappen på enheten nu.

Starta registrering

6

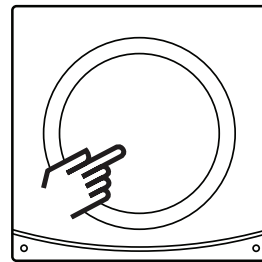

Danfoss 87H1447.10

7



Redigera enhetsnamn

ECL

abc def mno ABC 123

pqrs tuv wxyz

8



Lägg till serviceenhet

- 1 Placera enheten inom 1 meter från den här kontrollenheten och förbered installationen.
- 2

✓ Enheten lades till:
ECL-004/51
ECL

OK

9

DLG / ECL 110 hinzufügen

Wartungsgerät hinzufügen

- 1 Das Gerät im Abstand von 1 Meter zu diesem Regler halten und auf Installation vorbereiten. Hier tippen, wenn bereit:
- 2 Die Installationsstele am Gerät jetzt drücken.

Registrierung beginnen

6

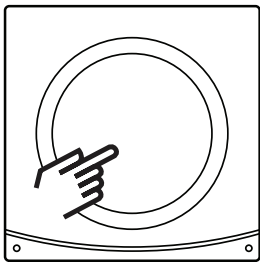

Danfoss 87H1447.10

7



Gerätenamen bearbeiten

ECL

abc def mno ABC 123

pqrs tuv wxyz

8



Wartungsgerät hinzufügen

- 1 Das Gerät im Abstand von 1 Meter zu diesem Regler halten und auf Installation vorbereiten.
- 2

✓ Gerät zugefügt:
ECL-004/51
ECL

OK

9

Troubleshooting

Error indication	Possible Causes
Impossible to add device, ECL, to the Danfoss Link™ CC system	<ul style="list-style-type: none"> - The distance between the Danfoss Link™ CC and the DLG has exceeded 1,5m. - Check if the MODBUS address of the ECL controller is set to 5. - Check your software version (house control/settings/about) of the Danfoss Link™ CC and update if older than MkIII 3.2; http://link.danfoss.com For further information, see separate instructions for Danfoss Link™ CC and Danfoss ECL Comfort 110 controller.
The connection to the ECL is lost	<ul style="list-style-type: none"> - The wireless signal is weak - Defective device For further information, see separate instruction for the Danfoss Link™ CC.
Danfoss Link™ indicates communication error on the ECL and the DLG for ECL has green light	<ul style="list-style-type: none"> - The cable connection between the ECL and the DLG is unstable / disconnected. - Check if the cable connection between the ECL and the DLG has defects. Fasten the screw terminals and if the error persists the cable has to be changed.
Flashing LED on DLG	<ul style="list-style-type: none"> - The CC is disconnected - The wireless signal is weak
Low room temperature (below comfort settings)	<ul style="list-style-type: none"> - Check if the ECL controller is left in setback due to lost connection. - If connection is ok check the heat curve slope setting of the ECL controller and increase if necessary.

Fejlfinding

Fejlmelding	Mulig årsag
Ikke muligt at tilføje enhed, ECL, til Danfoss Link™ CC systemet	<ul style="list-style-type: none"> - Afstanden mellem Danfoss Link™ CC og DLG overstiger 1,5 meter. - Kontroller, om MODBUS adressen i ECL regulatoren er indstillet til 5. - Kontroller, om din softwareversion (huskontrol/indstillinger/om) i Danfoss Link™ CC og opdater, hvis den er ældre end MkIII 3.2; http://link.danfoss.com For yderligere oplysninger, se separate vejledninger til Danfoss Link™ CC eller Danfoss ECL Comfort 110 regulator.
Forbindelsen til ECL er mistet	<ul style="list-style-type: none"> - Det trådløse signal er svagt - Defekt enhed For yderligere oplysninger, se separat vejledning til Danfoss Link™ CC.
Danfoss Link™ melder kommunikationsfejl på ECL og DLG for ECL lyser grønt	<ul style="list-style-type: none"> - Kabelforbindelsen imellem ECL og DLG er ustabil / afbrudt. - Kontroller kabelforbindelsen imellem ECL og DLG for defekter. Efter-spænd skrueterminaler, og vedbliver problemet, skift da kablet.
Blinkende udgangs-/alarmlysdiode på DLG	<ul style="list-style-type: none"> - CC er afbrudt - Det trådløse signal er svagt
Lav rumtemperatur (under komfortindstillinger)	<ul style="list-style-type: none"> - Kontroller, om ECL regulatoren er efterladt i reduceret drift pga. tabt forbindelse. - Hvis forbindelsen er ok, kontroller den valgte varmekurve i ECL regulatoren og hæv den hvis nødvendigt.

EC - Declaration of conformity

Hereby Danfoss A/S declares that this equipment is in compliance with the essential requirements and other relevant provisions of the Radio Equipment Directive.

Installation Guide, DLG / ECL 110 / Danfoss Link™

Felsökning

Felorsak	Möjlig orsak
Ej möjligt att ansluta ECL-enhet till Danfoss Link™ CC	<ul style="list-style-type: none"> - Avståndet mellan Danfoss Link™ CC och DLG överstiger 1,5 meter - Kontrollera att MODBUS adressen i ECL enheten är satt till 5. - Kontrollera om din mjukvaruversion (huskontroll, inställningar, om) i Danfoss Link™ CC är äldre än MkIII 3.2; http://link.danfoss.com För mer information, se separata instruktioner för Danfoss Link™ CC och Danfoss ECL Comfort 110.
Anslutning till ECL-enheten försvinner	<ul style="list-style-type: none"> - Den trådlösa signalen är svag - Defekt enhet För mer information, se separata instruktioner för Danfoss Link™ CC.
Danfoss Link™ indikerar kommunikationsfel med ECL-enheten och DGL för ECL-enheten indikerar grönt ljus	<ul style="list-style-type: none"> - Kabeln mellan ECL-enheten och DLG är ostabil/ej ansluten. - Kontrollera om kabelanslutningen mellan ECL-enheten och DLG har skador. Skruva åt skruvterminalerna och om felet kvarstår, byt kabeln.
Blinkande LED på DLG	<ul style="list-style-type: none"> - Danfoss Link™ CC är ej ansluten - Den trådlösa signalen är för svag
Låg rumstemperatur (lägre än värdet för komfortinställning)	<ul style="list-style-type: none"> - Kontrollera om ECL-enheten är i sänkingsläge pg. av bruten förbindelse. - Om anslutningen är korrekt, kontrollera värdet på värmekurvan i ECL-enheten och höj om det är nödvändigt.

Fehlersuche

Fehleranzeige	Mögliche Ursachen
Hinzufügen vom Gerät, ECL, zum Danfoss Link™ CC-System ist nicht möglich	<ul style="list-style-type: none"> - Der Abstand von 1,5 m zwischen Danfoss Link™ CC und DLG wurde überschritten. - Bitte kontrollieren, ob die ModBus Adresse im ECL auf 5 eingestellt ist. - Bitte die Softwareversion der Danfoss Link™ CC kontrollieren (Hausregelung/Einstellungen/Info über) und aktualisieren wenn älter als MkIII 3.2; http://link.danfoss.com Weitere Informationen siehe separate Anleitung für den Danfoss Link CC™ und Danfoss ECL Comfort 110.
Die Verbindung zum ECL ist abgebrochen	<ul style="list-style-type: none"> - Das Funksignal ist schwach - Gerät defekt Weitere Informationen siehe separate Anleitung für den Danfoss Link CC™.
Danfoss Link™ meldet Kommunikationsfehler für den ECL und der DLG für ECL leuchtet grün.	<ul style="list-style-type: none"> - Die Kabelverbindung zwischen dem ECL und der DLG ist instabil / abgebrochen. - Bitte die Kabelverbindung zwischen ECL und DLG auf Defekt kontrollieren. Schraubklemmen nachziehen, und falls das Problem weiter bestehen bleibt, wechseln Sie bitte das Kabel.
Blinkender Ausgang/Alarm-LEDs	<ul style="list-style-type: none"> - Der CC ist abgebrochen - Das Funksignal ist schwach
Zu niedrige Raumtemperatur (unter der Komfort-Einstellungen)	<p>Bitte kontrollieren, ob der ECL auf Grund unterbrochener Verbindung im reduzierten Betrieb hinterlassen ist.</p> <p>Ist die Verbindung in Ordnung, bitte die im ECL gewählte Heizkurve kontrollieren und bei Bedarf erhöhen.</p>

?  **DLG / ECL 110 / Danfoss Link™: www.heating.danfoss.com**

