

DE	Gebrauchsanleitung / Montageanleitung	2
FR	Mode d'emploi / Instructions de montage	3
EN	Instructions for use / assembly instructions	4
IT	Istruzioni per l'uso / Istruzioni per Installazione	5
ES	Modo de empleo / Instrucciones de montaje	6
NL	Gebruiksaanwijzing / Handleiding	7
DK	Brugsanvisning / Monteringsvejledning	8
PT	Instruções para uso / Manual de Instalação	9
PL	Instrukcja obsługi / Instrukcja montażu	10
CS	Návod k použití / Montážní návod	11
SK	Návod na použitie / Montážny návod	12
ZH	用户手册 / 组装说明	13
RU	Руководство пользователя / Инструкция по монтажу	14
HU	Használati útmutató / Szerelési útmutató	15
FI	Käyttöohje / Asennusohje	16
SV	Brugsanvisning / Monteringsanvisning	17
LT	Vartotojo instrukcija / Montavimo instrukcijos	18
HR	Upute za uporabu / Uputstva za instalaciju	19
TR	Kullanım kılavuzu / Montaj kılavuzu	20
RO	Manual de utilizare / Instrucțiuni de montare	21
EL	Οδηγίες χρήσης / Οδηγία συναρμολόγησης	22
SL	Navodilo za uporabo / Navodila za montažo	23
ET	Kasutusjuhend / Paigaldusjuhend	24
LV	Lietošanas pamācība / Montāžas instrukcija	25
SR	Uputstvo za upotrebu / Uputstvo za montažu	26
NO	Brugsanvisning / Montasjeveiledning	27
BG	Инструкция за употреба / Ръководство за монтаж	28
SQ	Udhëzuesi i përdorimit / Udhëzime rreth montimit	29
AR	دليل الاستخدام / تعليمات التجميع	30

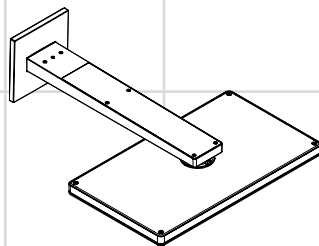

Rainmaker Select 460 2jet

24005400

Rainmaker Select 460 3jet

24007400



Sicherheitshinweise

- ⚠ Bei der Montage müssen zur Vermeidung von Quetsch- und Schnittverletzungen Handschuhe getragen werden.
- ⚠ Der Kopfbrausearm ist nur für das Halten der Kopfbrause ausgelegt, er darf nicht mit weiteren Gegenständen belastet werden!
- ⚠ Kinder, sowie Erwachsene mit körperlichen, geistigen und / oder sensorischen Einschränkungen dürfen das Produkt nicht unbeaufsichtigt benutzen. Personen, die unter Alkohol- oder Drogeneinfluss stehen, dürfen das Produkt nicht benutzen.
- ⚠ Der Kontakt der Brausestrahlen mit empfindlichen Körperstellen (z. B. Augen) muss vermieden werden. Es muss ein ausreichender Abstand zwischen Brause und Körper eingehalten werden.
- ⚠ Das Produkt darf nur zu Bade-, Hygiene- und Körperreinigungszwecken eingesetzt werden.

Montagehinweise

- Vor der Montage muss das Produkt auf Transportschäden untersucht werden. Nach dem Einbau werden keine Transport- oder Oberflächenschäden anerkannt.
- Die Leitungen und die Armatur müssen nach den gültigen Normen montiert, gespült und geprüft werden.
- Die in den Ländern jeweils gültigen Installationsrichtlinien sind einzuhalten.







Technische Daten

Betriebsdruck:	max. 0,6 MPa
Empfohlener Betriebsdruck:	0,15 - 0,4 MPa
(1 MPa = 10 bar = 147 PSI)	
Heißwassertemperatur:	max. 60°C
Thermische Desinfektion:	max. 70°C / 4 min

Dieses Produkt kann nicht in Verbindung mit hydraulisch und thermisch gesteuerten Durchlauferhitzern eingesetzt werden.

Das Produkt ist ausschließlich für Trinkwasser konzipiert!

Symbolbeschreibung

-  Warmwasser
-  Kaltwasser
-  In diesem Bereich ist eine Wandverstärkung notwendig.
-  Der nicht benötigte Abgang muss mit einem Blindstopfen abgedichtet werden.
-  Die Ablaufleistung muss mehr als 50 l/min betragen.
-  Ablauf
-  Kein essigsäurehaltiges Silikon verwenden!

Montagebeispiele (siehe Seite 32)

Maße (siehe Seite 31)

Durchflussdiagramm (siehe Seite 32)

Reinigung (siehe Seite 38) und beiliegende Broschüre

Serviceteile (siehe Seite 40)



Montage siehe Seite 36



⚠️ Consignes de sécurité

- ⚠️ Lors du montage, porter des gants de protection pour éviter toute blessure par écrasement ou coupure.
- ⚠️ Le bras de la douchette n'est conçu que pour tenir la douchette et ne doit pas servir à la suspension d'autres objets !
- ⚠️ Il est interdit aux enfants ainsi qu'aux adultes ayant des insuffisances physiques, psychiques et/ou motoriques d'utiliser la douche sans surveillance. De même, il est interdit à des personnes sous influence d'alcool ou de drogues d'utiliser la douche.
- ⚠️ Éviter le contact du jet de la douchette avec les parties sensibles du corps (telles par ex. que les yeux). Veiller à respecter un écart suffisant entre la douchette et le corps
- ⚠️ Le système de douche ne doit servir qu'à se laver et à assurer l'hygiène corporelle.

Instructions pour le montage

- Avant son montage, s'assurer que le produit n'a subi aucun dommage pendant le transport. Après le montage, tout dommage de transport ou de surface ne pourra pas être reconnu.
- Les conduites et la robinetterie doivent être montés, rincés et contrôlés selon les normes en vigueur.
- Les directives d'installation en vigueur dans le pays concerné doivent être respectées.







Informations techniques

Pression de service autorisée: max. 0,6 MPa
 Pression de service conseillée: 0,15 - 0,4 MPa
 (1 MPa = 10 bar = 147 PSI)
 Température d'eau chaude: max. 60 °C
 Désinfection thermique: max. 70 °C / 4 min

Les mitigeurs Hansgrohe ne doivent pas être utilisés avec des chauffe-eau instantané à commande hydraulique ou thermique.

Le produit est exclusivement conçu pour de l'eau potable!

Description du symbole

-  Eau chaude
-  Eau froide
-  Le mur n'a pas besoin d'être renforcé à cet endroit
-  La sortie non utilisée doit être condamnée avec un bouchon laiton.
-  Le débit de vidage doit être supérieur à 50 l/min.
-  Vidage
-  Ne pas utiliser de silicone contenant de l'acide acétique!

 **Exemples de montage** (voir pages 32)

 **Dimensions** (voir pages 31)

 **Diagramme du débit** (voir pages 32)

 **Nettoyage** (voir pages 38) et brochure ci-jointe

 **Pièces détachées** (voir pages 40)



Montage voir pages 36



Safety Notes

- ⚠ Gloves should be worn during installation to prevent crushing and cutting injuries.
- ⚠ The arm of the shower head is intended only to hold the shower head. Do not load it down with other objects!
- ⚠ Children as well as adults with physical, mental and/or sensoric impairments must not use this shower system without proper supervision. Persons under the influence of alcohol or drugs are prohibited from using this shower system.
- ⚠ Do not allow the streams of the shower touch sensitive body parts (such as your eyes). An adequate distance must be kept between the shower and you.
- ⚠ The shower system may only be used for bathing, hygienic and body cleaning purposes.

Installation Instructions

- Prior to installation, inspect the product for transport damages. After it has been installed, no transport or surface damage will be honoured.
- The pipes and the fixture must be installed, flushed and tested as per the applicable standards.
- The plumbing codes applicable in the respective countries must be observed.







Technical Data

Operating pressure:	max. 0,6 MPa
Recommended operating pressure: (1 MPa = 10 bar = 147 PSI)	0,15 - 0,4 MPa
Hot water temperature:	max. 60 °C
Thermal disinfection:	max. 70 °C / 4 min

This mixer cannot be used in conjunction with hydraulically, electronically or thermally controlled instantaneous heaters.

The product is exclusively designed for drinking water!

Symbol description

-  Warm water
-  Cold water
-  The wall must be reinforced in this area.
-  Plug the unused outlet.
-  The waste drain performance must be more than 50 l/min.
-  Waste
-  Do not use silicone containing acetic acid!



Installation example (see page 32)



Dimensions (see page 31)



Flow diagram
(see page 32)



Cleaning (see page 38) and enclosed brochure



Spare parts(see page 40)



Assembly see page 36



Indicazioni sulla sicurezza

- ⚠ Durante il montaggio, per evitare ferite da schiacciamento e da taglio bisogna indossare guanti protettivi.
- ⚠ Il braccio del soffione della doccia è progettato per sostenere solo quest'ultimo, non va sovraccaricato con altri oggetti!
- ⚠ I bambini e gli adulti affetti da menomazioni fisiche, psichiche e/o sensoriali devono utilizzare il sistema doccia solo sotto sorveglianza. Il prodotto non deve essere utilizzato da persone sotto l'effetto di droghe o alcolici.
- ⚠ Bisogna evitare il contatto fra il getto della doccia e parti del corpo delicate (ad es. gli occhi). Fra il soffione ed il corpo va mantenuta una distanza sufficiente.
- ⚠ Il sistema doccia deve essere utilizzato esclusivamente per l'igiene del corpo.

Istruzioni per il montaggio

- Prima del montaggio è necessario controllare che non ci siano stati danni durante il trasporto. Una volta eseguito il montaggio, non verranno riconosciuti eventuali danni di trasporto o delle superfici.
- Montare, lavare e controllare tubature e rubinetteria rispettando le norme correnti.
- Vanno rispettate le direttive di installazione nazionali vigenti nel rispettivo paese.







Dati tecnici

Pressione d'uso:	max. 0,6 MPa
Pressione d'uso consigliata: (1 MPa = 10 bar = 147 PSI)	0,15 - 0,4 MPa
Temperatura dell'acqua calda:	max. 60 °C
Disinfezione termica:	max. 70 °C / 4 min

I miscelatori non sono compatibili con le caldaie istantanee.

Il prodotto è concepito esclusivamente per acqua potabile!

Descrizione simbolo

-  Acqua calda
-  Acqua fredda
-  In questa zona è necessario un rinforzo della parete.
-  Chiudere con un tappo l'uscita non utilizzata.
-  La portata di scarico deve essere superiore a 50 l/min.
-  Scarico
-  Non utilizzare silicone contenente acido acetico!

 **Esempio di installazione** (vedi pagg. 32)

 **Ingombri** (vedi pagg. 31)

 **Diagramma flusso** (vedi pagg. 32)

 **Pulitura** (vedi pagg. 38) e brochure allegata

 **Parti di ricambio** (vedi pagg. 40)



Montaggio vedi pagg. 36



Indicaciones de seguridad

- ⚠ Durante el montaje deben utilizarse guantes para evitar heridas por aplastamiento o corte.
- ⚠ El brazo del pulverizador de ducha solo está previsto para soportar el pulverizador de ducha y no debe cargarse con otros objetos!
- ⚠ Niños, así como adultos con limitaciones corporales, mentales y/o sensoriales no deben utilizar el sistema de duchas sin vigilancia. Personas que se encuentran bajo el efecto de alcohol o drogas, no deben utilizar el sistema de duchas.
- ⚠ Debe evitarse el contacto del chorro del pulverizador con partes sensibles del cuerpo (por ej. ojos). Debe mantenerse una distancia suficiente entre pulverizador y cuerpo.
- ⚠ La grifería solo debe ser utilizada para fines de baño, higiene y limpieza corporal.

Indicaciones para el montaje

- Antes del montaje se debe examinarse el producto contra daños de transporte. Después de la instalación so se reconoce ningún daño de transporte o de superficie.
- Los conductos y la grifería deben montarse, lavarse y comprobarse según las normas vigentes.
- Es obligatorio el cumplimiento de las directrices de instalación vigentes en el país respectivo.







Datos técnicos

Presión en servicio:	max. 0,6 MPa
Presión recomendada en servicio:	0,15 - 0,4 MPa (1 MPa = 10 bar = 147 PSI)
Temperatura del agua caliente:	max. 60°C
Desinfección térmica:	max. 70°C / 4 min

Los mezcladores no pueden usarse con calentadores instantaneos mandados hidráulicamente o térmicamente.

El producto ha sido concebido exclusivamente para agua potable.

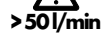
Descripción de símbolos

-  Agua caliente
-  Agua fría
-  En este sector es necesario un refuerzo del muro.
-  La salida que no se utiliza debe ser tapada.
-  El caudal de desagüe debe ser como mínimo de 50 l/min
-  Desagüe
-  No utilizar silicona que contiene ácido acético!

Ejemplos de montaje (ver página 32)

Dimensiones (ver página 31)

Diagrama de circulación (ver página 32)

Limpiar (ver página 38) y folleto anexo





Repuestos (ver página 40)



Montaje ver página 36



Veiligheidsinstructies

-  Bij de montage moeten ter voorkoming van knel- en snijwonden handschoenen worden gedragen.
-  De arm van de hoofddouche is uitsluitend voor het vasthouden van de hoofddouche bedoeld en mag niet met verdere voorwerpen worden belast!
-  Kinderen en volwassenen met lichamelijke, geestelijke en/of sensorische beperkingen mogen het douchesysteem niet zonder toezicht gebruiken. Personen onder invloed van alcohol of drugs mogen het douchesysteem niet gebruiken.
-  Het contact van de douchestraal met gevoelige lichaamsdelen (bijv. ogen) moet worden voorkomen. Er moet voldoende afstand tussen douche en lichaam aangehouden worden.
-  Het douchesysteem mag alleen voor het wassen, hygiënische doeleinden en voor de lichaamreiniging worden gebruikt.

Montage-instructies

- Vóór de montage moet het product gecontroleerd worden op transportschade. Na de inbouw wordt geen transport- of oppervlakteschade meer aanvaard.
- De leidingen en armaturen moeten gemonteerd, gespoeld en gecontroleerd worden volgens de geldige normen.
- De in de overeenkomstige landen geldende installatierichtlijnen moeten nageleefd worden.

Technische gegevens

Werkdruk: max.	max. 0,6 MPa
Aanbevolen werkdruk: (1 MPa = 10 bar = 147 PSI)	0,15 - 0,4 MPa
Temperatuur warm water:	max. 60 °C
Thermische desinfectie:	max. 70 °C / 4 min

Hansgrohe kranen mogen niet in verbinding met hydraulische en thermisch gestuurde geisers geplaatst worden.

Het product is uitsluitend ontworpen voor drinkwater!

Symboolbeschrijving

-  Warm water
-  Koud water
-  In dit bereik is een wandversterking noodzakelijk.
-  De niet benodigde uitgang moet met een blindstop worden afgedicht.
-  De afvoercapaciteit moet meer dan 50 l/min bedragen.
-  Afvoer
-  Gebruik geen zuurhoudende silicone!

Montagevoorbeelden (zie blz. 32)

Maten (zie blz. 31)

Doorstroombiagram (zie blz. 32)

Reinigen (zie blz. 38) en bijgevoegde brochure

Service onderdelen (zie blz. 40)



Montage zie blz. 36



Sikkerhedsanvisninger

- △ Ved monteringen skal der bruges handsker for at undgå kvæstelser og snitsår.
- △ Stangen til hovedbruseren er kun beregnet til at holde hovedbruseren. Den må ikke belastes med andre genstande!
- △ Børn som også voksne med fysiske, mentale og / eller sensoriske begrænsninger må ikke bruge brusersystemet uden opsyn. Personer som er under indflydelse af alkohol eller narkotika må ikke bruge brusersystemet.
- △ Bruserstrålens kontakt med sensitive områder (f.eks. øjne) skal undgås. Der skal være en tilstrækkelig afstand mellem bruseren og kroppen.
- △ Brusersystemet må kun bruges til bade-, hygiejne og rengøringsformål.

Monteringsanvisninger

- Før monteringen skal produktet kontrolleres for transportskader. Efter monteringen godkendes transportskader eller skader på overfladen ikke længere.
- Ledningerne og armaturerne skal monteres, skylles og kontrolleres iht. de gældende standarder.
- Installationsbestemmelserne, der gælder i det enkelte land, skal overholdes.

Tekniske data

Driftstryk:	max. 0,6 MPa
Anbefalet driftstryk:	0,15 - 0,4 MPa
(1 MPa = 10 bar = 147 PSI)	
Varmtvandstemperatur:	max. 60 °C
Termisk desinfektion:	max. 70 °C / 4 min

Hansgrohe armaturer kan ikke anvendes i forbindelse med hydraulisk og termisk styrede vandvarmere.

Produktet er udelukkende beregnet til drikkevand!

Symbolbeskrivelse





-  Varmt vand
-  Kold vand
-  I dette område er en forstærkning af væggen nødvendigt.
-  Afgangen, der ikke benyttes, skal afproppes.
-  Afløbskapaciteten skal være mere end 50 l/min.
-  Afløb
-  **Raindrain**
Der må ikke benyttes eddikesyreholdig silikone!
-  **Monteringseksempler** (se s. 32)
-  **Målene** (se s. 31)
-  **Gennemstrømningsdiagram** (se s. 32)
-  **Rengøring** (se s. 38) og vedlagt brochure
-  **Reserve dele** (se s. 40)



Montering se s. 36



Avisos de segurança

-  Durante a montagem devem ser utilizadas luvas de protecção, de modo a evitar ferimentos resultantes de entalamentos e de cortes.
-  O braço do chuveiro foi concebido apenas para servir de apoio à cabeça do chuveiro, pelo que não pode ser sujeito a cargas de objectos adicionais!
-  Crianças e adultos com deficiências motoras, mentais e/ou sensoriais não podem utilizar o sistema de duche sem monitorização. Pessoas que estejam sob a influência de álcool ou drogas não podem utilizar o sistema de duche.
-  Deve-se evitar o contacto dos jactos de água com partes do corpo sensíveis (p. ex. olhos). É necessário manter uma distância suficiente entre o chuveiro e o corpo.
-  O sistema de duche só pode ser utilizado para fins de higiene pessoal.

Avisos de montagem

- Antes da montagem deve-se controlar o produto relativamente a danos de transporte. Após a montagem não são aceites quaisquer danos de transporte ou de superfície.
- As tubagens e a torneira têm que ser montadas, enxaguadas e verificadas de acordo com as normas em vigor.
- A prescrições de instalação válidas nos respetivos países devem ser respeitadas.







Dados Técnicos

Pressão de funcionamento:	max. 0,6 MPa
Pressão de func. recomendada:	0,15 - 0,4 MPa (1 MPa = 10 bar = 147 PSI)
Temperatura da água quente:	max. 60 °C
Desinfecção térmica:	max. 70 °C / 4 min

As misturadoras não são compatíveis com o uso de esquentadores instantâneos hidráulicos, electrónicos ou térmicos.

Este produto foi única e exclusivamente concebido para água potável!

Descrição do símbolo

-  Água quente
-  Água fria
-  Nesta zona é necessário um reforço na parede.
-  Tamponar a saída não utilizada.
-  Capacidade de escoamento tem que ser superior a 50 l/min.
-  Escoamento
-  Não utilizar silicone que contenha ácido acético!

Exemplos de montagem (ver página 32)

Medidas (ver página 31)

Fluxograma (ver página 32)

Limpeza (ver página 38) e brochura em anexo

Peças de substituição (ver página 40)



Montagem ver página 36



! Wskazówki bezpieczeństwa

- △ Aby uniknąć zranień, takich jak zgniecenia czy przecięcia, podczas montażu należy nosić rękawice.
- △ Ramię prysznica jest przystosowane do trzymania głowicy prysznica i nie może być obciążane innymi przedmiotami!
- △ Zarówno dzieci, jak i dorośli z fizycznymi, psychicznymi i/lub sensorycznymi ograniczeniami nie mogą korzystać z prysznica bez opieki. Osoby znajdujące się pod wpływem alkoholu lub narkotyków nie mogą korzystać z prysznica.
- △ Należy unikać kontaktu strumienia wyływającego z głowicy z wrażliwymi częściami ciała (np. oczami). Należy zachowywać odpowiednią odległość pomiędzy głowicą a ciałem.
- △ Prysznic może być używany tylko do kąpieli, higieny i czyszczenia ciała.

Wskazówki montażowe

- Przed montażem należy skontrolować produkt pod kątem szkód transportowych. Po montażu nie widać żadnych szkód transportowych ani szkód na powierzchni.
- Przewody i armatura muszą być montowane, płukane i kontrolowane według obowiązujących norm.
- Należy przestrzegać wytycznych instalacyjnych obowiązujących w danym kraju.

Dane techniczne

Ciśnienie robocze:	maks. 0,6 MPa
Zalecane ciśnienie robocze:	0,15 - 0,4 MPa
(1 MPa = 10 bary = 147 PSI)	
Temperatura wody gorącej:	maks. 60°C
Dezynfekcja termiczna:	maks. 70°C / 4 min

Armatura Hansgrohe może być wykorzystywana w połączeniu z hydraulicznie, elektronicznie i termicznie sterowanym ogrzewaczem przepływowym.

Produkt stworzono wyłącznie do wody pitnej!

Opis symbolu

-  Ciepła woda
-  Zimna woda
-  W tym obszarze konieczne jest wzmocnienie ściany.
-  Niewykorzystany wylot należy zakorkować dołożonym w dostawie korkiem.
-  Wydajność odpływu musi być wyższa niż 50 l/min.
-  Odpływ
-  Nie stosować silikonów zawierających kwas octowy!
-  **Przykłady montażowe** (patrz strona 32)
-  **Wymiary** (patrz strona 31)
-  **Schemat przepływu** (patrz strona 32)
-  **Czyszczenie** (patrz strona 38) i dołączona broszura
-  **Części serwisowe** (patrz strona 40)



Montaż patrz strona 36



Bezpečnostní pokyny

- △ Pro zabránění řezným zraněním a pohmožděninám je nutné při montáži nosit rukavice.
- △ Držák sprchové hlavice je dimenzován pouze pro držení sprchové hlavice a nesmí se zatěžovat dalšími předměty!
- △ Děti a dospělá osoba s tělesným, duševním a / nebo smyslovým postižením nesmí produkt používat bez dozoru. Osoby pod vlivem alkoholu nebo drog nesmí produkt používat.
- △ Je nutné zabránit kontaktu vodních paprsků sprchy s měkkými částmi těla (např. očima). Je nutné dodržovat dostatečný odstup mezi sprchou a tělem.
- △ Produkt smí být používán pouze ke koupání a za účelem tělesné hygieny.

Pokyny k montáži

- Před montáží je třeba produkt zkontrolovat, zda nebyl při transportu poškozen. Po zabudování nebudou uznány žádné škody způsobené transportem nebo poškození povrchu.
- Vedení a armatura musí být namontovány, propláchnuty a otestovány podle platných norem.
- Je třeba dodržovat montážní pravidla platné v dané zemi.

Technické údaje

Provozní tlak:	max. 0,6 MPa
Doporučený provozní tlak: (1 MPa = 10 bar = 147 PSI)	0,15 - 0,4 MPa
Teplota horké vody:	max. 60 °C
Tepelná desinfekce:	max. 70 °C / 4 min

Tento produkt nemůže být používán ve spojení s hydraulicky a teplotně řízenými průtokovými ohříváči.

Výrobky Hansgrohe jsou vhodné pro přímý kontakt s pitnou vodou.

Popis symbolů

-  Teplá voda
-  Studená voda
-  V této oblasti je potřebné zesílení stěny.
-  Nepoužitý vývod musí být utěsněn zaslepovací zátkou.
-  Odtokový výkon musí být vyšší než 50 l/min.
- >50l/min**
-  Odtok
- Raindrain**
-  Nepoužívat silikon s obsahem kyseliny octové!
-  **Příklady montáže** (viz strana 32)
-  **Rozměry** (viz strana 31)
-  **Diagram průtoku** (viz strana 32)
-  **Čištění** (viz strana 38) a přiložená brožura
-  **Servisní díly** (viz strana 40)



Montáž viz strana 36



Bezpečnostné pokyny

- ⚠ Pri montáži musíte nosiť rukavice, aby ste predišli pomliaždeninám a rezným poraneniam.
- ⚠ Rameno držiaka hlavice sprchy je určené len na uchytenie hlavice sprchy a nesmie sa zaťažovať inými predmetmi!
- ⚠ Produkt nesmú bez dozoru používať deti, ako aj dospelé osoby s telesným, duševným a/alebo zmyslovým postihnutím. Produkt nesmú používať ani osoby, ktoré sú pod vplyvom alkoholu alebo drog.
- ⚠ Vyhýbajte sa kontaktu vodného lúča sprchy s citlivými miestami tela (napr. oči). Dodržiavajte dostatočnú vzdialenosť medzi sprchou a telom.
- ⚠ Produkt sa smie používať len na kúpanie a telesnú hygienu.

Pokyny pre montáž

- Pred montážou musíte produkt skontrolovať, či nebol počas transportu poškodený. Po zabudovaní nebudú uznané žiadne škody spôsobené transportom alebo poškodenia povrchu.
- Ledningarna och blandaren måste monteras, spolás igenom och kontrolleras enligt de gällande normerna.
- Je potrebné dodržiavať smernice o inštalácii, ktoré sú práve teraz platné v krajinách.

Technické údaje

Prevádzkový tlak:	max. 0,6 MPa
Doporučený prevádzkový tlak: (1 MPa = 10 bar = 147 PSI)	0,15 - 0,4 MPa
Teplota teplej vody:	max. 60 °C
Termická dezinfekcia:	max. 70 °C / 4 min

Tento produkt sa nesmie používať v spojení s hydraulicky a teplotne riadenými prietokovými ohrievačmi.

Výrobok je koncipovaný výhradne pre pitnú vodu!

Popis symbolov

-  Teplá voda
-  Studená voda
-  V tejto oblasti je potrebné zosilnenie steny.
-  Nepoužitý vývod musí byť zaslepený zátkou.
-  Výkon odtoku musí byť vyšší ako 50 l/min.
- >50l/min**
-  Odtok
- Raindrain**
-  Nepoužívať silikón s obsahom kyseliny octovej!
-  **Príklady montáže** (viď strana 32)
-  **Rozmery** (viď strana 31)
-  **Diagram prietoku** (viď strana 32)
-  **Čistenie** (viď strana 38) a priložená brožúra
-  **Servisné diely** (viď strana 40)



Montáž vid' strana 36



⚠️ 安全技巧

- △ 装配时为避免挤压和切割受伤，必须戴上手套。
- △ 头顶莲蓬头夹持杆只为夹持头顶莲蓬头而设计，不得让其承载其它物品！
- △ 不得让儿童和肢体、精神和/或意识有障碍的成人在不受监管的情况下使用淋浴系统。受酒精或毒品影响的人员不得使用淋浴系统。
- △ 必须避免让身体敏感部位（如眼睛）接触到莲蓬头喷水。必须保持莲蓬头与人头之间有足够的距离。
- △ 淋浴系统只允许作为洗浴、卫生和洁身之用。

安装提示

- 安装前必须检查产品是否受到运输损害。安装后将不认可运输损害或表面损伤。
- 管道和阀门必须根据通用标准进行安装、冲洗和检查。
- 请遵守当地国家现行的安装规定。

技术参数

工作压强: 最大 0,6 MPa
 推荐工作压强: 0,15 - 0,4 MPa
 (1 MPa = 10 bar = 147 PSI)

热水温度: 最大 60°C
 热力消毒: 最大 70°C / 4 分钟

该产品不可与液控和热控即热式热水器连接使用。
 该产品专为饮用水设计！

符号说明

-  热水
-  冷水
-  该区域需要一个加固边壁。
-  插入不使用的插座。
-  排水功率必须大于 50 l/min。
- >50l/min**
 排水口
- Raindrain**
 请勿使用含有乙酸的硅！
-  安装示意 (参见第页 32)
-  大小 (参见第页 31)
-  流量示意图 (参见第页 32)
-  清洗 (参见第页 38) 并附有小手册
-  备用零件(参见第页 40)



安装 参见第页 36



Указания по технике безопасности **Описание символов**

- Во время монтажа следует надеть перчатки во избежание прищемления и порезов.
- Кронштейн верхнего душа предназначен только для подсоединения верхнего душа. Запрещается подвешивать на него другие предметы!
- Дети, а также взрослые с физическими, умственными и/или сенсорными недостатками должны пользоваться изделием только под присмотром. Запрещается пользоваться изделием в состоянии алкогольного или наркотического опьянения.
- Не допускайте попадания струи воды из разбрызгивателя на чувствительные части тела (например, на глаза). Разбрызгиватель следует устанавливать на достаточном расстоянии от тела.
- Изделие разрешается использовать только в гигиенических целях: для принятия ванны и личной гигиены.

Указания по монтажу

- Перед монтажом следует проверить изделие на предмет повреждений при перевозке. После монтажа претензии о возмещении ущерба за повреждения при перевозке или повреждения поверхностей не принимаются.
- Трубы и арматура должны быть установлены, промыты и проверены в соответствии с действующими нормами.
- Необходимо соблюдать требования по монтажу, действующие в соответствующих странах.

Технические данные

Рабочее давление: не более 0,6 МПа
 Рекомендуемое рабочее давление: 0,15 - 0,4 МПа
 (1 МПа = 10 bar = 147 PSI)
 Температура горячей воды: не более 60°C
 Термическая дезинфекция: не более 70°C / 4 мин

Применение этой продукции при наличии гидравлических и проточных нагревателей с тепловой регулировкой не допускается.

Изделие предназначено исключительно для питьевой воды!

-  Теплая вода
-  Холодная вода
-  В этой области требуется укрепление стены.
-  Ненужный выход необходимо уплотнить с помощью заглушки.
-  Слив должен иметь производительность более 50 л/мин.
-  Слив
-  Не применяйте силикон, содержащий уксусную кислоту.

варианты установки (см. стр. 32)

Размеры (см. стр. 31)

Схема потока (см. стр. 32)

Очистка (см. стр. 38) и прилагаемая брошюра

Комплект (см. стр. 40)



Монтаж см. стр. 36



Biztonsági utasítások

- △ A szerelésnél a zúzódások és vágási sérülések elkerülése érdekében kesztyűt kell viselni.
- △ A zuhanyfej karja csak a zuhanyfej tartására alkalmas, és nem szabad más tárgyakkal megterhelni!
- △ Gyermekek, valamint testileg, szellemileg fogyatékos és / vagy érzékelésben korlátozott személyek nem használhatják felügyelet nélkül a terméket. Alkohol és kábítószer befolyása alatt álló személyek nem használhatják a terméket.
- △ Kerülni kell a zuhansugár érintkezését érzékeny testrészekkel (pl. szemek). Be kell tartani a megfelelő távolságot a zuhanyfej és a test között.
- △ A terméket csak fürdéshez, mosakodáshoz, és egészségügyi tisztálkodáshoz szabad használni.

Szerelési utasítások

- A szerelés előtt ellenőrizni kell, hogy a terméknek nincs-e szállítási sérülése. Beépítés után a szállítási- vagy felületi sérüléseket nem ismerik el.
- A vezetékeket és a csaptelepet az érvényes szabványoknak megfelelően kell felszerelni, öblíteni és ellenőrizni
- Az egyes országokban érvényes installációs irányelveket be kell tartani.



Műszaki adatok

Üzemi nyomás:	max. 0,6 MPa
Ajánlott üzemi nyomás: (1 MPa = 10 bar = 147 PSI)	0,15 - 0,4 MPa
Forróvíz hőmérséklet:	max. 60 °C
Termikus fertőtlenítés:	max. 70 °C / 4 perc

Ha a zuhany működik, akkor ennek a zuhanykarral együtt kb. 10 kg a tömege. Ezért csak a falnak megfelelő rögzítő anyagot szabad használni! A mellékelt csavarok és tiplik csak tömör falakhoz használhatók.

A terméket kizárólag ivóvízhez tervezték!

Szimbólumok leírása

-  Melegvíz
-  Hidegvíz
-  Ezen a területen a fal megerősítésére van szükség.
-  A fölösleges kimenetet vakdugóval kell lezárni.
-  A lefolyó teljesítményének 50l/percnél magasabbnak kell lenni
-  Lefolyó
-  **Raindrain**
Ne használjon ecetsavtartalmú szilikon!



Szerelési példák (lásd a oldalon 32)



Méretet (lásd a oldalon 31)



Átfolyási diagram
(lásd a oldalon 32)



Tisztítás (lásd a oldalon 38) és mellékelt brossúrával



Tartozékok(lásd a oldalon 40)



Szerelés lásd a oldalon 36



Turvallisuusohjeet

- △ Asennuksessa on käytettävä käsiineitä puristumien ja viiltojen aiheuttamien tapaturmien estämiseksi.
- △ Pääsuihkun varsi on tarkoitettu vain kannattamaan pääsuihkua. Sitä ei saa kuormittaa muilla esineillä!
- △ Lapset ja ruumiillisesti, henkisesti ja/tai aistillisesti rajoittuneet aikuiset eivät saa käyttää suihkujärjestelmää ilman valvontaa. Alkoholin tai huumeiden vaikutuksessa olevat henkilöt eivät saa käyttää suihkujärjestelmää.
- △ Suihkuveden kontaktia herkempien ruumiinosien (esim. silmien) kanssa on vältettävä. Suihkun ja vartalon välissä on oltava riittävä väli.
- △ Suihkujärjestelmää saa käyttää ainoastaan kylpy-, hygienia- ja puhdistustarkoituksiin.

Asennusohjeet

- Ennen asennusta on tarkastettava tuotteen mahdolliset kuljetusvahingot. Asennuksen jälkeen kuljetus- ja pintavaurioita ei hyväksytä.
- Putket ja hana on asennettava, huuhdeltava ja tarkastettava voimassa olevien standardien mukaisesti.
- Jokaisessa maassa on noudatettava siellä päteviä asennusohjeita.

Tekniset tiedot

Käyttöpaine:	maks. 0,6 MPa
Suosittelut käyttöpaine:	0,15 - 0,4 MPa
(1 MPa = 10 bar = 147 PSI)	
Kuuman veden lämpötila:	maks. 60 °C
Lämpödesinfektio:	maks. 70 °C / 4 min

Tätä tuotetta ei voi käyttää hydraulisesti tai termisesti ohjattujen läpivirtauskuumentimien yhteydessä.

Tuote on suunniteltu käytettäväksi ainoastaan juomaveden kanssa!

Merkin kuvaus

-  Lämmin vesi
-  Kylmä vesi
-  Tässä kohdassa seinää on vahvistettava
-  Käyttämätön lähtöliitin on suljettava sulku-tulpalla.
-  Poisvirtaustehon on oltava enemmän kuin 50l/min.
-  Veden poisvirtaus
-  **Raindrain**
Älä käytä etikahappopitoista silikonial!

 **Asennusesimerkkejä** (katso sivu 32)

 **Mitat** (katso sivu 31)

 **Virtausdiagrammi** (katso sivu 32)

 **Puhdistus** (katso sivu 38) ja oheinen esite

 **Varaosat** (katso sivu 40)



Asennus katso sivu 36



! Säkerhetsanvisningar

- △ Handskar ska bäras under monteringsarbetet så att man kan undvika kläm- och skärskadorgen werden.
- △ Armen som håller huvudduschen är bara konstruerad för detta; den får inte belastas med andra föremål!
- △ Barn samt vuxna med fysiska, psykiska eller sensoriska funktionshinder får inte använda produkten ensam. Personer som är påverkade av alkohol eller droger får inte använda produkten.
- △ Undvik att rikta duschstrålarna mot känsliga kroppsdelar (t. ex. ögonen). Det måste finnas ett tillräckligt stort avstånd mellan duschen och kroppen.
- △ Produkten får bara användas till kroppshygien med bad och dusch.

Monteringsanvisningar

- Det måste undersökas om produkten har transportskador innan den monteras. Efter monteringen accepteras inga transport- eller ytskiktsskador.
- Ledningarna och blandaren måste monteras, spolas igenom och kontrolleras enligt de gällande normerna.
- De installationsriktlinjer som gäller i länderna ska följas.

Tekniska data

Driftstryck:	max. 0,6 MPa
Rek. driftstryck:	0,15 - 0,4 MPa
(1 MPa = 10 bar = 147 PSI)	
Varmvattentemperatur:	max. 60°C
Termisk desinfektion:	max. 70°C / 4 min

Denna produkt kan inte användas tillsammans med hydrauliskt och termiskt styrda varmvattenberedare.

Produkten är enbart avsedd för dricksvatten!

Symbolbeskrivning

-  Varmvatten
-  Kallvatten
-  Šioje zonoje būtinās sienos sutvirtinimas
-  Det utlopp som inte behövs måste tätas med en blindstopp.
-  Avloppet måste klara mer än 50 l/min.
- >50l/min**
-  Avlopp
- Raindrain**
-  Använd inte silikon som innehåller ättiksyra!



Monteringsexempel (se sidan 32)



Måtten (se sidan 31)



Flödesschema

(se sidan 32)



Rengöring (se sidan 38) och medföljande broschyr







Reservdelar(se sidan 40)



Montering se sidan 36



Saugumo technikos nurodymai

-  Apsaugai nuo užspaudimo ir įsijovimo montavimo metu mūvėkite pirštines.
-  Dušo laikiklis skirtas tik dušo galvutei laikyti, todėl neturi būti apkraunamas kitokiais daiktais!
-  Gaminį draudžiama naudoti vaikams, taip pat suaugusiems su fizine, dvasine negale ir (arba) sensorikos sutrikimais. Gaminį taip pat draudžiama naudoti asmenims, apsvaigusiems nuo alkoholio arba narkotikų.
-  Būtina vengti dušo vandens srovės kontakto su jautriomis kūno vietomis (pvz., akimis). Todėl būtina laikytis tinkamo atstumo nuo dušo.
-  Gaminys turi būti naudojamas tik maudymuisi, kūno higienai ir švarai palaikyti.

Montavimo instrukcija

- Prieš montuojant būtina patikrinti, ar gaminys nebuvo pažeistas transportavimo metu. Sumontavus pretenzijos dėl transportavimo ir paviršiaus pažeidimų nepriimamos.
- Vamzdžiai ir sujungimai turi būti montuojami, plaunami ir tikrinami pagal galiojančias normas.
- Laikykitės atitinkamoje šalyje galiojančių direktyvų dėl įrengimo.













Techniniai duomenys

Darbinis slėgis: ne daugiau kaip 0,6 MPa
 Rekomenduojamas slėgis: 0,15 - 0,4 MPa
 (1 MPa = 10 barų = 147 PSI)
 Karšto vandens temperatūra: ne daugiau kaip 60 °C
 Terminis dezinfekavimas: ne daugiau kaip 70 °C / 4 min

Šio produkto negalima naudoti kartu su hidrauliškai ir termiškai valdomu tekančio vandens šildytuvu.

Produktas skirtas tik geriamajam vandeniui!

Simbolio aprašymas

-  Šiltas vanduo
-  Šaltas vanduo
-  Šioje zonoje būtinas sienos sutvirtinimas
-  Nenaudojamą išėjimą užaklinti.
-  Nutekėjimo našumas turi būti ne mažesnis 50 l/min
-  Nutekėjimas
-  Nenaudokite silikono, kurio sudėtyje yra acto rūgšties!
-  **Montavimo pavyzdžiai** (žr. psl. 32)
-  **Išmatavimai** (žr. psl. 31)
-  **Pralaidumo diagrama** (žr. psl. 32)
-  **Valymas** (žr. psl. 38) ir pridama brošiūra
-  **Atsarginės dalys** (žr. psl. 40)





Sigurnosne upute

- ⚠ Prilikom montaže se radi sprječavanja prignječenja i posjekotina moraju nositi rukavice.
- ⚠ Nosač tuša iznad glave je dimenzioniran samo za držanje danog tuša i ne smije se opterećivati drugim predmetima!
- ⚠ Djeca, kao i tjelesno, mentalno i/ili senzorno hendikepirane odrasle osobe ne smiju se koristiti proizvodom bez nadzora. Osobe koje su pod utjecajem alkohola ili droga ne smiju se koristiti proizvodom.
- ⚠ Mora se izbjegavati kontakt mlaza iz tuša s osjetljivim dijelovima tijela (npr. očima). Tijelo korisnika mora biti dovoljno udaljeno od tuša.
- ⚠ Proizvod se smije primjenjivati samo za kupanje, tuširanje i osobnu higijenu.

Upute za montažu

- Prije montaže mora se provjeriti je li proizvod oštećen prilikom transporta. Nakon ugradnje se ne priznaju nikakve reklamacije koje se odnose na površinska i transportna oštećenja.
- Cijevi i armatura moraju biti postavljeni, isprani i testirani prema važećim normama.
- Obvezno se moraju uvažiti propisi o instalacijama koji vrijede u dotičnoj zemlji.



Tehnički podaci

Najveći dopušteni tlak:	tlak 0,6 MPa
Preporučeni tlak:	0,15 - 0,4 MPa
(1 MPa = 10 bar = 147 PSI)	
Temperatura vruće vode:	tlak 60 °C
Termička dezinfekcija:	tlak 70 °C / 4 min

Ovaj proizvod se ne može rabiti uz hidraulički i termički regulirane protočne bojlere.

Proizvod je koncipiran isključivo za pitku vodu!

Opis simbola

-  Topla voda
-  Hladna voda
-  U ovom je području potrebno ojačanje zida.
-  Potrebno je ostaviti zatvoren izlaz koji se ne koristi
-  Protok vode mora biti veći od 50 l/min.
- >50l/min**
-  Odvod
- Raindrain**
-  Nemojte koristiti silikon koji sadrži otcenu kiselinu!
-  **Primjeri instalacija** (pogledaj stranicu 32)
-  **Mjere** (pogledaj stranicu 31)
-  **Dijagram protoka** (pogledaj stranicu 32)
-  **Čišćenje** (pogledaj stranicu 38) i priložena brošura
-  **Rezervni dijelovi** (pogledaj stranicu 40)





⚠ Güvenlik uyarıları

- ⚠ Montaj esnasında ezilme ve kesilme gibi yaralanmaları önlemek için eldiven kullanılmalıdır.
- ⚠ Başlıklı püskürtücü kolu yalnızca başlıklı püskürtücünün tutulması için tasarlanmıştır, başka nesnelere üzerine yük bindirilmemelidir!
- ⚠ Bedensel, ruhsal ve/veya sensörük engelli çocuk ve yetişkinler gözetimsiz olarak duş sistemini kullanmamalıdır. Alkol veya uyuşturucu etkisinde olanlar duş sistemini kullanmamalıdır.
- ⚠ Püskürtme başlıklarının hassas organlara teması (örn. gözler) önlenmelidir. Püskürtücü ile beden arasında yeterli mesafe bırakılmalıdır.
- ⚠ Duş sistemi yalnızca banyo, hijyen ve beden temizliği amaçları doğrultusunda kullanılabilir.

Montaj açıklamaları

- Montaj işleminden önce ürün nakliye hasarları yönünden kontrol edilmelidir. Montaj işleminden sonra nakliye veya yüzey hasarları için sorumluluk üstlenilmemektedir.
- Boruların ve armatürün montajı, yıkanması ve kontrolü geçerli normlara göre yapılmalıdır.
- Ülkelerde geçerli kurulum yönetmeliklerine riayet edilmelidir.







Teknik bilgiler

İşletme basıncı:	azami 0,6 MPa
Tavsiye edilen işletme basıncı: (1 MPa = 10 bar = 147 PSI)	0,15 - 0,4 MPa
Sıcak su sıcaklığı:	azami 60 °C
Termik dezenfeksiyon:	azami 70 °C / 4 dak

Bu ürün hidrolik ve termik kumandalı akış ısıtıcılarıyla bağlantılı olarak kullanılmamalıdır.

Ürün sadece şebeke suyu için tasarlanmıştır!

Simge açıklaması

-  Sıcak su
-  Soğuk su
-  Bu alanda duvarın kalınlaştırılması gereklidir.
-  Kullanılmayan çıkış bir kör tapayla izole edilmelidir.
-  Akış kapasitesi 50 l/dak üzerinde olmalıdır.
-  Akış
-  Asetik asit içeren silikon kullanmayın!

 **Montaj Örneği** (bakınız sayfa 32)

 **Ölçüleri** (bakınız sayfa 31)

 **Akış diyagramı**
(bakınız sayfa 32)

 **Temizleme** (bakınız sayfa 38) ve birlikte verilen broşür

 **Yedek Parçalar**(bakınız sayfa 40)



Montajı bakınız sayfa 36



Instrucțiuni de siguranță

- ⚠ La montare utilizați mănuși pentru evitarea contuziunilor și tăierii mâinilor.
- ⚠ Brațul parei de duș este destinat doar pentru a susține para, acesta nu poate fi prevăzut cu alte obiecte.
- ⚠ Copiii și adulții cu dizabilități corporale, mintale și senzoriale nu pot utiliza sistemul de duș nesupravegheați. De asemenea este interzisă utilizarea sistemului de duș de către persoane, care se află sub influența alcoolului sau a drogurilor.
- ⚠ Evitați contactul jetului de apă cu părțile de corp sensibile (de ex. ochii). Țineți dușul la o distanță corespunzătoare de corp.
- ⚠ Sistemul de duș poate fi utilizat doar pentru spălarea, menținerea igienei și curățarea corpului.

Instrucțiuni de montare

- Înainte de instalare verificați, dacă produsul prezintă deteriorări de transport. După instalare garanția nu acoperă deteriorările de transport și cele de suprafață.
- Conductele și bateriile trebuie montate, spălate și verificate conform normelor în vigoare.
- Respectați reglementările referitoare la instalare valabile în țara respectivă.

Date tehnice

Presiune de funcționare:	max. 0,6 MPa
Presiune de funcționare recomandată:	0,15 - 0,4 MPa (1 MPa = 10 bar = 147 PSI)
Temperatura apei calde:	max. 60 °C
Dezinfecție termică:	max. 70 °C / 4 min

Acest produs nu poate fi utilizat în combinație cu boilere cu flux continuu hidraulice sau comandate termic.

Produsul este destinat exclusiv pentru apă potabilă.

Descrierea simbolurilor

-  Apă caldă
-  Apă rece
-  În această zonă este nevoie de întărirea peretelui.
-  Racordurile neutilizate trebuie acoperite cu dop etanș.
-  Capacitatea de evacuare trebuie să fie mai mare de 50 l/min.
-  Deterivor
-  Nu utilizați silicon cu conținut de acid acetic!
-  **Exemple de montare** (vezi pag. 32)
-  **Dimensiuni** (vezi pag. 31)
-  **Diagrama de debit** (vezi pag. 32)
-  **Curățare** (vezi pag. 38) și broșura alăturată
-  **Piese de schimb** (vezi pag. 40)



Montare vezi pag. 36



⚠ Υποδείξεις ασφαλείας

- ⚠ Για να αποφύγετε τραυματισμούς κατά τη συναρμολόγηση πρέπει να φοράτε γάντια.
- ⚠ Ο βραχιόνιας του ντους κεφαλιού έχει μελετηθεί μόνο για να κρατά ο ντους κεφαλιού, δεν επιτρέπεται να φορτίζεται με άλλα αντικείμενα!
- ⚠ Παιδιά ή ενήλικες με μειωμένες σωματικές, διανοητικές και/ή αισθητήριες ανεπάρκειες δεν επιτρέπεται να χρησιμοποιούν το προϊόν χωρίς επιτήρηση. Άτομα υπό την επήρεια οινοπνεύματος ή ναρκωτικών δεν επιτρέπεται να χρησιμοποιούν σε καμία περίπτωση το προϊόν.
- ⚠ Η επαφή δέσμης νερού του ντους με ευαίσθητες περιοχές του σώματος (π.χ. μάτια) πρέπει να αποφεύγεται. Διατηρείτε επαρκή απόσταση ανάμεσα στο ντους και το σώμα.
- ⚠ Το προϊόν επιτρέπεται να χρησιμοποιείται μόνο σαν μέσο λουτρού, υγιεινής και καθαρισμού του σώματος.

Οδηγίες συναρμολόγησης

- Πριν τη συναρμολόγηση πρέπει να εξεταστεί το προϊόν για ζημιές μεταφοράς. Μετά την εγκατάσταση δεν αναγνωρίζονται ζημιές από τη μεταφορά ή επιφανειακές ζημιές.
- Οι σωλήνες και η μπαταρία πρέπει να τοποθετηθούν σύμφωνα με τα ισχύοντα πρότυπα, να τεθούν υπό πίεση και να δοκιμαστούν.
- Θα πρέπει να τηρούνται οι οδηγίες εγκατάστασης που ισχύουν σε κάθε κράτος.

Τεχνικά Χαρακτηριστικά

Λειτουργία πίεσης:	έως 0,6 MPa
Συνιστώμενη λειτουργία πίεσης:	0,15 - 0,4 MPa
(1 MPa = 10 bar = 147 PSI)	
Θερμοκρασία ζεστού νερού:	έως 60 °C
Θερμική απολύμανση:	έως 70 °C / 4 min

Αυτό το προϊόν δεν μπορεί να χρησιμοποιηθεί σε συνδυασμό με υδραυλικούς και θερμικά ελεγχόμενους ταχυθερμοσίφωνες.

Το προϊόν έχει σχεδιαστεί αποκλειστικά για πόσιμο νερό!.

Περιγραφή συμβόλων

- Ζεστό νερό
- Κρύο νερό
- Σε αυτήν την περιοχή είναι απαραίτητη μία ενίσχυση του τοίχου.
- Τα περιττά στόμια εξόδου πρέπει να στεγανοποιηθούν με ένα τυφλό πώμα.
- Η αποχετευτική ικανότητα της βαλβίδας εκροής πρέπει να υπερβαίνει τα 1/min.
- Βαλβίδα εκροής
- Μην χρησιμοποιείτε σιλικόνη που περιέχει οξικό οξύ!
- Παραδείγματα συναρμολόγησης** (βλ. Σελίδα 32)
- Διαστάσεις** (βλ. Σελίδα 31)
- Διάγραμμα ροής** (βλ. Σελίδα 32)
- Καθαρισμός** (βλ. Σελίδα 38) και συνημμένο φυλλάδιο
- Ανταλλακτικά** (βλ. Σελίδα 40)



Συναρμολόγηση βλ. Σελίδα 36



Varnostna opozorila

- △ Pri montaži je treba nositi rokavice, da se preprečijo poškodbe zaradi zmečkanja ali urezov.
- △ Nosilna roka naglavne prhe je konstruirana le za nošenje prhe in je ne smete obremeniti z drugimi predmeti!
- △ Otroci kot tudi odrasle osebe z omejenimi telesnimi, duševnimi in/ali senzoričnimi sposobnostmi ne smejo nenadzorovano uporabljati tega izdelka. Osebe, ki so pod vplivom alkohola ali drog, tega izdelka ne smejo uporabljati.
- △ Izogibati se je treba stiku prhalnega curka z občutljivimi deli telesa (npr. očmi). Med telesom in prho mora biti vedno zadosten razmik.
- △ Ta izdelek se sme uporabljati le z namenom umivanja, vzdrževanja higiene in telesne nege.

Navodila za montažo

- Pred montažo je treba izdelek preveriti glede morebitnih transportnih poškodb. Po vgradnji transportne ali površinske poškodbe ne bodo več priznane.
- Cevi in armaturo je treba montirati, izprati in preveriti po veljavnih standardih.
- Upoštevati je treba pravilnike o inštalacijah, ki veljajo v posamezni državi.

Tehnični podatki

Delovni tlak:	maks. 0,6 MPa
Priporočeni delovni tlak: (1 MPa = 10 bar = 147 PSI)	0,15 - 0,4 MPa
Temperatura tople vode:	maks. 60 °C
Termična dezinfekcija:	maks. 70 °C / 4 min

Tega proizvoda ni možno uporabiti v povezavi s hidravlično in termično krmiljenimi pretočnimi grelniki.

Proizvod je zasnovan izključno za sanitarno vodo!

Opis simbola

-  Topla voda
-  Mrzla voda
-  V tem območju je potrebno ojačanje stene.
-  Izhod, ki ga ne potrebujete, zatesnite s čepom.
-  Odtočna kapacitetamora znašati več kot 50 l/min.
-  Odtok
-  Ne smete uporabiti silikona, ki vsebuje ocetno kislino!
-  **Primeri montaže** (glejte stran 32)
-  **Mere** (glejte stran 31)
-  **Diagram pretoka** (glejte stran 32)
-  **Čiščenje** (glejte stran 38) in priložena brošura
-  **Rezervni deli**(glejte stran 40)



Montaža glejte stran 36



⚠ Ohutusjuhised

- ⚠ Kandke paigaldamisel muljumis- ja löikevigastuste vältimiseks kindaid.
- ⚠ Dušipea hoidik on mõeldud ainult dušipea hoidmiseks ja seda ei tohi muude esemetega koormata!
- ⚠ Lapsed, samuti kehaliste, vaimsete või tajupiirangutega täiskasvanud ei tohi dušisüsteemi järelvalveta kasutada. Alkoholi või narkootikumide mõju all olevad isikud ei tohi dušisüsteemi kasutada.
- ⚠ Duši veejoad ei tohi kokku puutuda tundlike kehaosadega (nt silmad). Jätke duši ja keha vahele piisav vahe.
- ⚠ Toodet tohib kasutada ainult pesemis-, hügieeni- ja kehapuhastamisesmärkidel.

Paigaldamisjuhised

- Enne paigaldamist tuleb toodet kontrollida transpordikahjustuste osas. Pärast paigaldamist ei tunnustata enam transpordi- või pinnakahjustuste kaebuseid.
- Voolikute ja segisti paigaldamisel, loputamisel ja kontrollimisel tuleb lähtuda kehtivatest normatiividest.
- Vastavas riigis kehtivaid paigalduseeskirju tuleb järgida.

Tehnilised andmed

Töörõhk	maks. 0,6 MPa
Soovitatav töörõhk: (1 MPa = 10 baari = 147 PSI)	0,15 - 0,4 MPa
Kuuma vee temperatuur:	maks. 60°C
Termiline desinfektsioon:	maks. 70°C / 4 min

Seda toodet ei saa kasutada koos hüdrauliliselt ja termiliselt juhitava läbivoolusoojendiga.

Toode on ette nähtud eranditult joogivee jaoks!

Sümbolite kirjeldus

- Soe vesi
- Külम vesi
- Selles alas tuleb seina tugevdada.
- Mittevajalik väljavool tuleb sulgeda korgiga.
- Äravoolu jõudlus peab olema suurem kui 50 l/min.
- Äravoole
- Ärge kasutage äädikhapet sisaldavat silikooni!
- Paigalduse näited** (vt lk 32)
- Mõõtude** (vt lk 31)
- Läbivooludiagramm** (vt lk 32)
- Puhastamine** (vt lk 38) ja kaasas olev brošüür
- Varuosad** (vt lk 40)



Paigaldamine vt lk 36



Drošības norādes

- △ Montāžas laikā, lai izvairītos no saspiedumiem un iegriezumiem, nepieciešams nēsāt cimdus.
- △ Galvas dušas statīvs paredzēts vienīgi galvas dušas atbalstīšanai, to nedrīkst noslogot ar citiem priekšmetiem!
- △ Bērni, kā arī pieaugušie ar fiziskiem, garīgiem un / vai sensoriskiem ierobežojumiem nedrīkst lietot šo produktu bez uzraudzības. Personas, kas atrodas alkohola vai narkotisko vielu iespaidā, nedrīkst lietot šo dušas sistēmu.
- △ Nepieciešams izvairīties no dušas strūkļas tieša kontakta ar jutīgām ķermeņa daļām (piem., acīm). Nepieciešams ievērot pietiekošu attālumu starp dušu un ķermeni.
- △ Šo produktu drīkst izmantot tikai, lai mazgātos, higiēnai un ķermeņa tīrīšanai.

Norādījumi montāžai

- Pirms montāžas nepieciešams pārbaudīt, vai produktam transportēšanas laikā nav radušies bojājumi. Pēc iebūvēšanas bojājumi, kas radušies transportēšanas laikā, vai virsmas bojājumi netiek atzīti.
- Caurulvadi un armatūra ir jāuzstāda, jāizskalo un jāpārbauda saskaņā ar spēkā esošajiem standartiem.
- Jāievēro attiecīgās valstīs spēkā esošās montāžas prasības.





Tehniskie dati

Darba spiediens:	maks. 0,6 MPa
ļeteicamais darba spiediens: (1 MPa = 10 bar = 147 PSI)	0,15 - 0,4 MPa
Karstā ūdens temperatūra:	maks. 60°C
Termiskā dezinfekcija :	maks. 70°C / 4 min

Šo izstrādājumu nevar uzstādīt kopā ar hidrauliski un termiski vadītu caurplūdes sildītāju.

Izstrādājums ir paredzēts tikai dzeramajam ūdenim!

Simbolu nozīme

-  Siltais ūdens
-  Aukstais ūdens
-  Šajā zonā ir nepieciešams pastiprināt sienu.
-  Neizmantoto izteku aizbāzt ar aizbāzni.
-  Noteces veiktspējai jābūt vairāk nekā 50 l/min.
-  Notece
-  Raindrain
Neizmantot silikonu, kas satur etiķskābi!



Montāžas piemēri (skat. lpp. 32)



Izmērus (skat. lpp. 31)



Caurplūdes diagramma
(skat. lpp. 32)



Tīrīšana (skat. lpp. 38) un klāt pievienotais buklets



Rezerves daļas (skat. lpp. 40)



Montāža skat. lpp. 36



Sigurnosne napomene

- △ Prilikom montaže se radi sprečavanja prignječenja i posekotina moraju nositi rukavice.
- △ Nosač tuša iznad glave je dimenzioniran samo za držanje datog tuša i ne sme se opterećivati drugim predmetima!
- △ Deca, kao i telesno, mentalno i/ili senzorno hendikepirane odrasle osobe ne smeju da koriste proizvod bez nadzora. Osobe koje su pod uticajem alkohola ili droga ne smeju da koriste proizvod.
- △ Mora se izbegavati kontakt mlaza iz tuša sa osetljivim delovima tela (npr. očima). Telo korisnika mora biti na dovoljnom odstojanju od tuša.
- △ Proizvod sme da se koristi samo za kupanje, tuširanje i ličnu higijenu.

Instrukcije za montažu

- Pre montaže se mora proveriti da li je proizvod oštećen pri transportu. Nakon ugradnje se ne priznaju nikakve reklamacije koje se odnose na površinska i transportna oštećenja.
- Vodovi i armatura moraju biti postavljeni, isprani i testirani prema važećim normama.
- Treba se pridržavati propisa koji u određenim zemljama važe za instalacije.

Tehnički podaci

Radni pritisak:	maks. 0,6 MPa
Preporučeni radni pritisak:	0,15 - 0,4 MPa
(1 MPa = 10 bar = 147 PSI)	
Temperatura vruće vode:	maks. 60 °C
Termička dezinfekcija:	maks. 70 °C / 4 min

Ovaj proizvod se ne može koristiti uz hidraulički i termički regulisane protočne bojlere.

Proizvod je koncipiran isključivo za pijaću vodu!

Opis simbola

-  Topla voda
-  Hladna voda
-  U ovoj oblasti je potrebno ojačanje zida.
-  Izlaz koji se ne koristi, mora se zatvoriti slepim čepom.
-  Kapacitet odvoda mora biti veći od 50 l/min.
-  Ispust
-  **Raindrain**
-  Nemojte koristiti silikon koji sadrži sirćetnu kiselinu!
-  **Primeri montaže** (vidi stranu 32)
-  **Mere** (vidi stranu 31)
-  **Dijagram protoka** (vidi stranu 32)
-  **Čišćenje** (vidi stranu 38) i priložena brošura
-  **Rezervni delovi** (vidi stranu 40)



Montaža vidi stranu 36



Sikkerhetshenvisninger

- △ Bruk hansker under montasjen for å unngå klem- og kuttskader.
- △ Armen til hodedusjen er kun laget for å holde hodedusjen. Den må ikke belastes med andre gjenstander!
- △ Barn og voksne med fysiske og psykiske og/eller sensoriske handicap skal ikke bruke dusjsystemet uten oppsyn. Personer som er påvirket av alkohol eller narkotika skal ikke bruke dusjsystemet.
- △ Dusjstrålen skal ikke komme i kontakt med ømfintlige kroppsdeler (f.eks. øynene). Overhold en tilstrekkelig avstand mellom dusjen og kroppen.
- △ Dusjsystemet skal kun brukes for bade-, hygiene- og kroppshygiene.

Montagehenvisninger

- Før montasjen skal produktet sjekkes for transportskader. Etter monteringen aksepteres ikke noen transport- eller overflateskader.
- Ledningene og armaturen skal monteres, spyles og sjekkes iht. de gyldige normer.
- Gjeldende retningslinjer for rørleggerarbeid i de enkelte land skal følges.

Tekniske data

Driftstrykk	maks. 0,6 MPa
Anbefalt driftstrykk: (1 MPa = 10 bar = 147 PSI)	0,15 - 0,4 MPa
Varmtvannstemperatur	maks. 60°C
Termisk desinfisering:	maks. 70°C / 4 min

Dette produktet kan ikke brukes i forbindelse med hydraulisk og termisk styrte gjennomstrømningovner.
Produktet er utelukkende designet for drikkevann!

Symbolbeskrivelse

-  Varmtvann
-  Kaldtvann
-  I dette området skal vegg forsterkes.
-  Utgangen som ikke brukes kan tettes med en blindplugg.
-  Avløp ytelse skal være mer enn 50 l/min.
- >50l/min**
-  Avløp
- Raindrain**
-  Ikke bruk silikon som inneholder eddiksyre!

 **Montasje-eksempel** (se side 32)

 **Mål** (se side 31)

 **Gjennomstrømningsdiagram**
(se side 32)

 **Rengjøring** (se side 38) og vedlagt brosjyre





 **Service-deler** (se side 40)



Montasje se side 36



Указания за безопасност

-  При монтажа трябва да се носят ръкавици, за да се избегнат наранявания поради притискане или порязване.
-  Рамото на разпръсквателя за главата е разработена само, за да държи разпръсквателя за главата, то не бива да се натоварва с други предмети!
-  Не е позволено деца, както и възрастни с физически, умствени и / или сензорни ограничения да използват продукта без надзор. Не е позволено използването на системата на продукта от лица, употребили алкохол или дрога.
-  Трябва да се избягва контакта на струите на разпръсквателя с чувствителни части на тялото (например очите). Между разпръсквателя и тялото трябва да се спазва достатъчно разстояние.
-  Позволено е използването на продукта само за къпане, хигиена и цели на почистване на тялото.

Указания за монтаж

- Преди монтажа продуктът трябва да се провери за транспортни щети. След монтажа не се признават транспортни или повърхностни щети.
- Тръбопроводите и арматурата трябва да се монтират, промият и проверят в съответствие с валидните норми.
- Трябва да бъдат спазвани валидните в съответните страни предписания за инсталиране.







Технически данни

Работно налягане: макс. 0,6 МПа
 Препоръчително работно налягане: 0,15 - 0,4 МПа
 (1 МПа = 10 bar = 147 PSI)
 Температура на горещата вода: макс. 60 °C
 Термична дезинфекция: макс. 70 °C / 4 мин

Този продукт не може да се използва във връзка с хидравлично и термично управляеми проточни нагреватели.

Продуктът е разработен само за питейна вода!

Описание на символите

-  Топла вода
-  Студена вода
-  В тази област е необходимо подсилване на стената.
-  Излишният извод може да се уплътни с глуха пробка.
-  Мощността на изтичане трябва да бъде повече от 50 л/мин.
-  Отвеждане
-  Не използвайте силикон, съдържащ оцветна киселина!

 **Примери за монтаж** (вижте стр. 32)

 **Размери** (вижте стр. 31)

 **Диаграма на потока** (вижте стр. 32)

 **Почистване** (вижте стр. 38) и приложена брошура





 **Сервизни части** (вижте стр. 40)



Монтаж вижте стр. 36



Udhëzime sigurie

-  Për të evituar lëndimet e pickimeve ose të prerjeve gjatë procesit të montimit duhet që të vishni doreza.
-  Mbjajtësja e kokës së dushit është projektuar vetëm për mbajtjen e kokës së dushit dhe nuk duhet që të rëndohet me objekte të tjera!
-  Fëmijët dhe të rriturit me aftësi të kufizuara fizike, mendore dhe/ose ndijuese nuk duhet ta përdorin produktin pa qenë nën mbikëqyrje. Personat që janë nën ndikimin e drogave ose të alkoolit nuk duhet ta përdorin produktin.
-  Kontakti i valëve të dushit me pjesët e ndjeshme të trupit (p.sh. me sytë) duhet që të shmanget. Midis dushit dhe trupit duhet që të mbahet një distancë e mjaftueshme.
-  Produkti duhet të përdoret vetëm qëllimet e banjave, të higjienës dhe të larjes së trupit.

Udhëzime për montimin

- Përpara montimit duhet që produkti të kontrollohet për dëmtime nga transporti. Pas instalimit nuk do të njihet asnjë dëmtim nga transporti ose dëmtim i sipërfaqes.
- Tubacionet dhe rubinetet duhet që të montohen, të shpëlahen dhe të kontrollohen sipas standardeve në fuqi
- Duhet të respektohen linjat udhëzuese të instalimit, të vlefshme për vendet respektive.

Të dhëna teknike

Presioni gjatë punës	maks. 0,6 MPa
Presioni i rekomanduar: (1 MPa = 10 bar = 147 PSI)	0,15 - 0,4 MPa
Temperatura e ujit të ngrohtë	maks. 60°C
Dezinfektim Termik:	maks. 70°C / 4 min

Ky produkt nuk mund të përdoren me ngrohës elektrikë të ujit të drejtuar në mënyrë hidraulike ose termike.

Produkti është projektuar ekskluzivisht për ujë të pijshëm!

Përshkrimi i simbolit

-  Uji i ngrohtë
-  Uji i ftohtë
-  Në këtë zonë është i nevojshëm një përforsim i murit.
-  Dalja që nuk nevojitet duhet izoluar me tapë qorre.
-  Kapaciteti i shkarkimit duhet të jetë më shumë se 50 l/minutë.
-  Shkarkimi
-  Mos përdorni silikon që në përbërje ka acid acetik.
-  **Shembuj të montimit** (shih faqen 32)
-  **Përmasat** (shih faqen 31)
-  **Diagrami i qarkullimit** (shih faqen 32)
-  **Pastrimi** (shih faqen 38) dhe broshura bashkëngjitur
-  **Pjesët e servisit** (shih faqen 40)



Montimi shih faqen 36



وصف الرمز

ماء دافئ



ماء بارد



يلزم هذا في النطاق وجود تقوية للحائط.



قم بسد المنفذ غير المستخدم.



يجب أن تكون قدرة الصرف أكبر من 50 لتر/دقيقة



تصريف



Raindrain

هام! لا تستخدم السليكون الذي يحتوي على أمضاض!



مثال على التركيب (راجع صفحة 32)



أبعاد (راجع صفحة 31)



رسم للصرف

(راجع صفحة 32)



التنظيف (راجع صفحة 38) والكتيب

المرفق



قطع الغيار (راجع صفحة 40)



تنبيهات الأمان ⚠

يجب إرتداء قفازات لليد أثناء التركيب لتجنب حدوث أخطار الإنحشار أو الجروح.

وظيفة ذراع دش الرأس هي فقط الإمساك بدش الرأس، ولذلك يجب عدم التحميل عليه بأشياء أخرى.

لا يسمح لأي أطفال أو أفراد بالغين يعانون من إعاقات بدنية أو ذهنية أو حسية أو يعانون من جميع هذه الإعاقات باستخدام المنتج إلا تحت إشراف آخرين. كما أنه لا يسمح لأي شخص تحت تأثير تناول الكحول أو المخدرات باستخدام نظام الدش.

يجب تجنب حدوث اتصال مباشر بين الماء الخارج من رأس الدش وبين أجزاء الجسم الحساسة (مثل العينين). يجب وجود مسافة كافية بين رأس الدش والجسم.

لا يجب استخدام نظام الدش إلا في أغراض الاستحمام والأغراض الصحية وأغراض تنظيف الجسم.

تعليمات التركيب

قبل القيام بعملية التركيب، يجب فحص المنتج للتأكد من خلوه من أية تلفيات ناتجة عن النقل. بعد القيام بعملية التركيب، لن يتم الاعتراف بوجود أية تلفيات سطحية أو تلفيات ناتجة عن عملية النقل.

يجب تركيب وغسيل واختبار التوصيلات وخلطات المياه طبقاً للمعايير السارية.

يجب مراعاة القواعد الخاصة بالتركيب وأعمال السباكة وفقاً للوائح الخاصة بكل بلد.

المواصفات الفنية

ضغط التشغيل: الحد الأقصى 0,6 ميجاباسكال

ضغط التشغيل الموصى به: 0,15 - 0,4 ميجاباسكال (1 ميجاباسكال = 10 بار = 147 PSI)

درجة حرارة الماء الساخن: الحد الأقصى 60°C

تعقيم حراري: الحد الأقصى 70°C / 4 الدقيقة

لا يمكن إستعمال هذا المنتج مع سخانات الماء الفورية الهيدروليكية أو الحرارية.

المنتج مخصص فقط لماء الشرب!



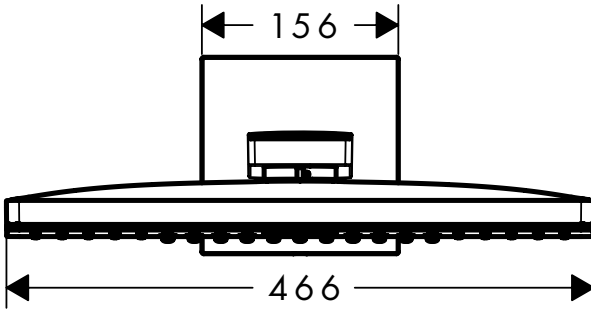
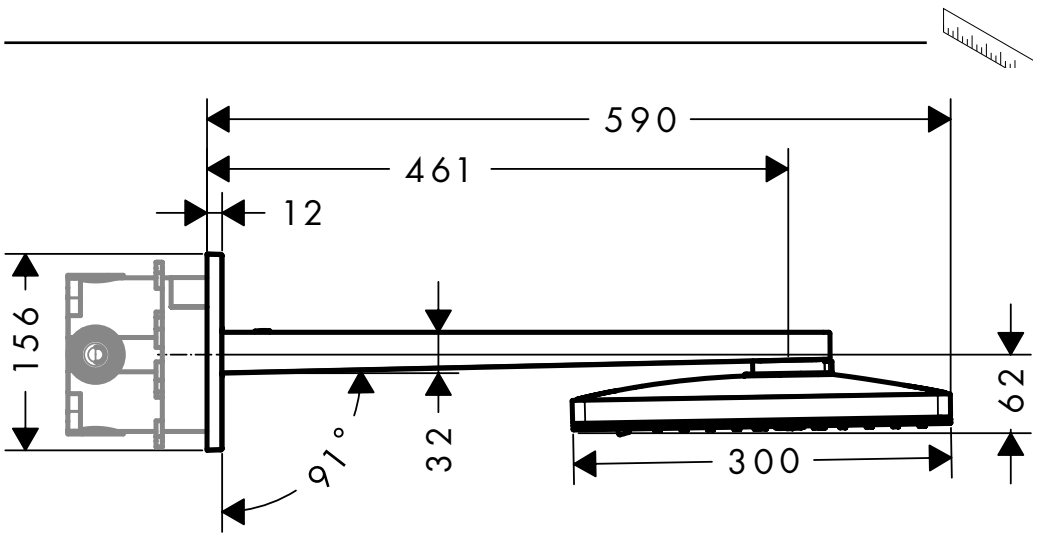

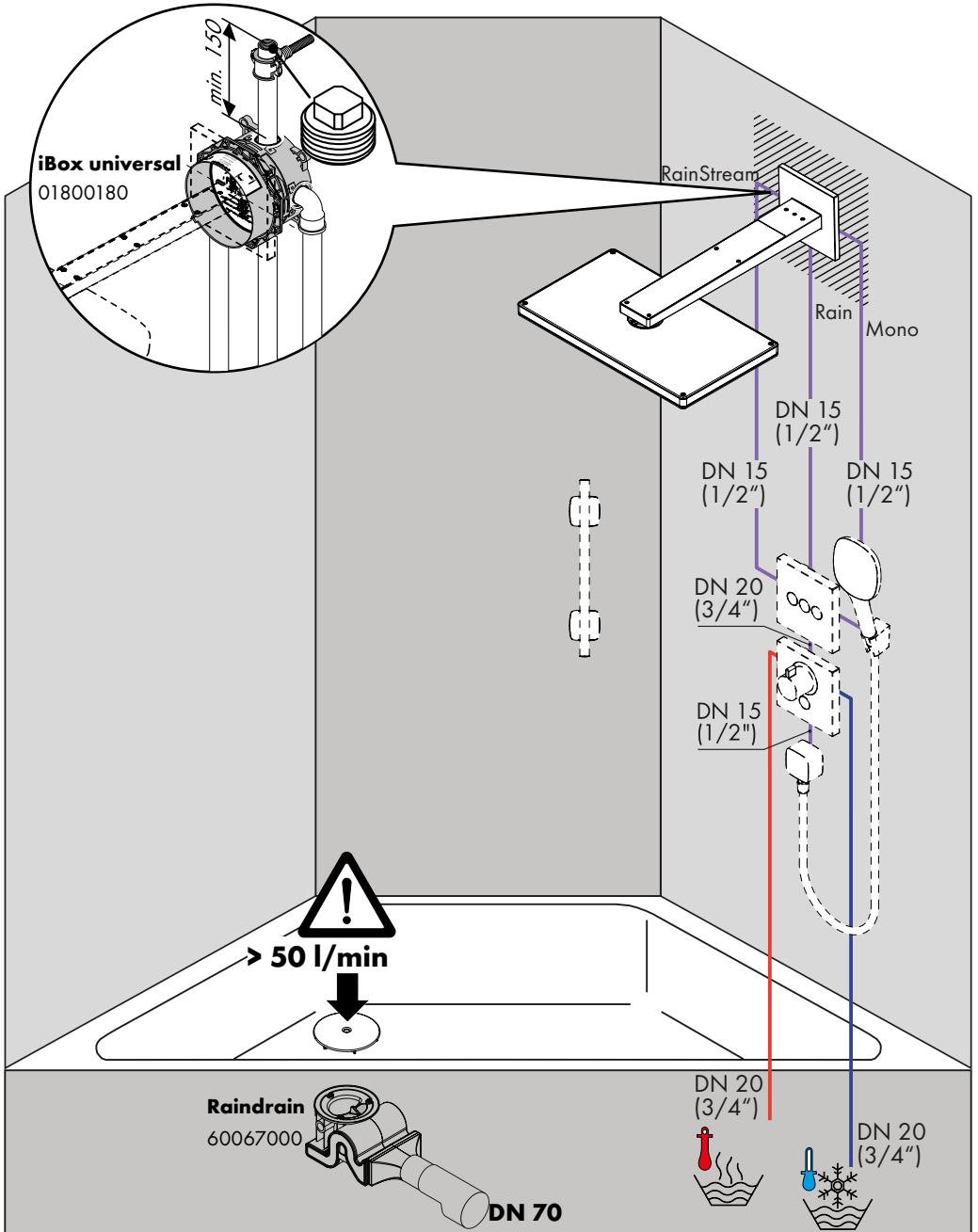

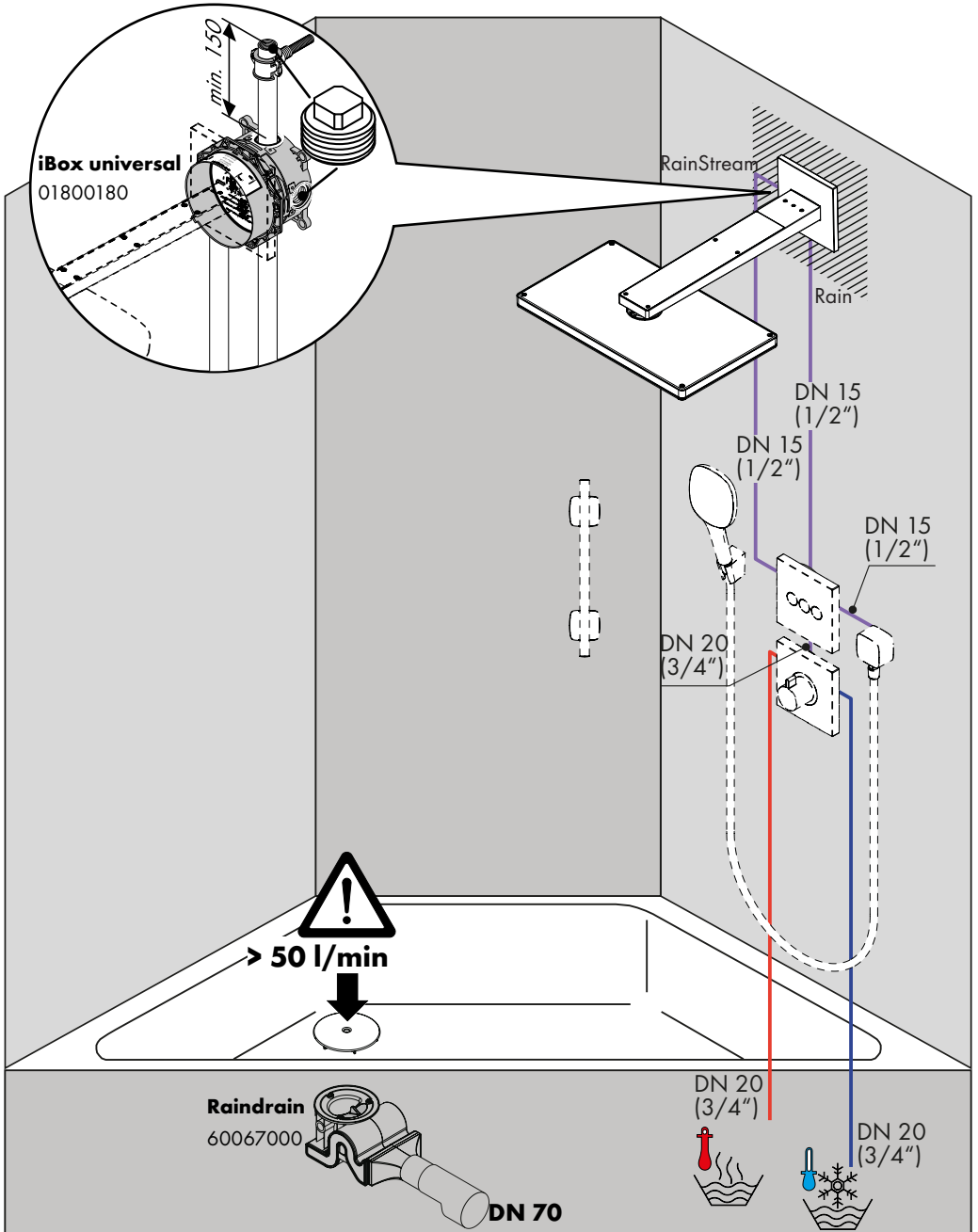

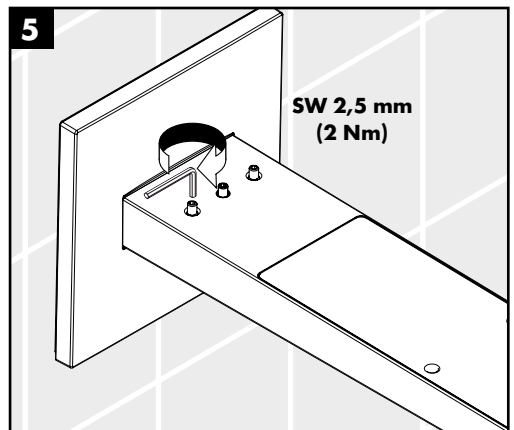
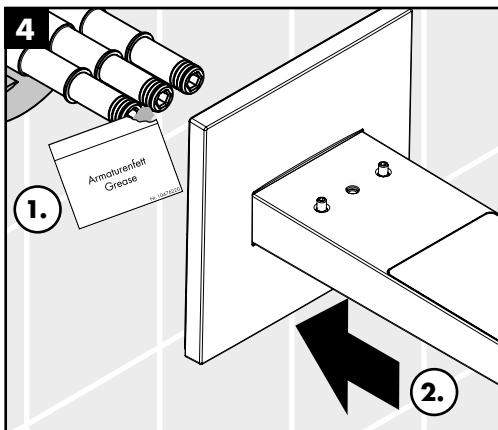
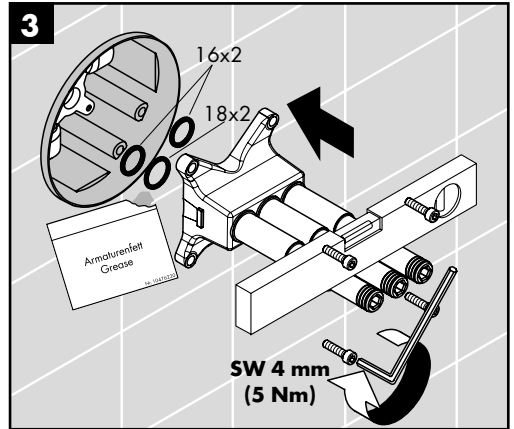
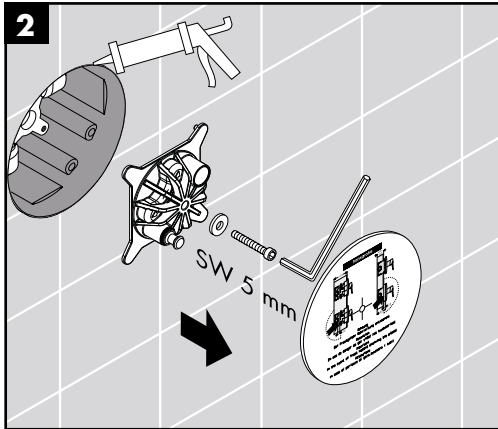
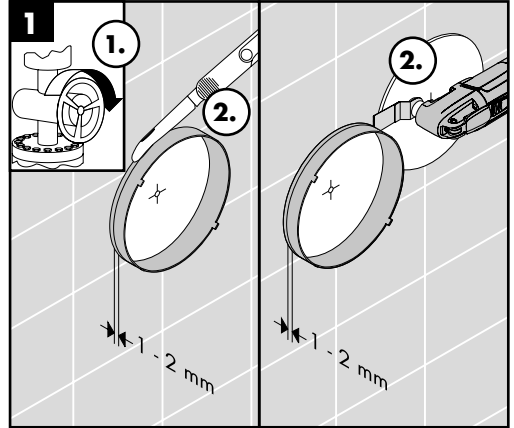
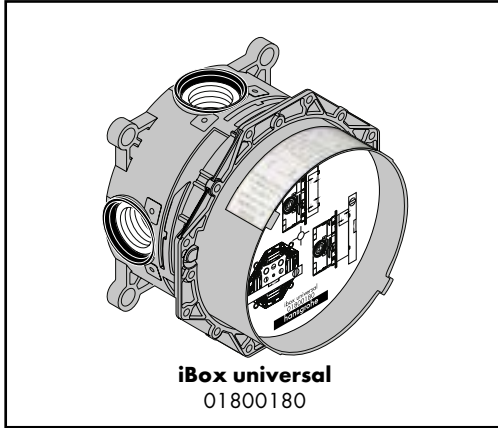

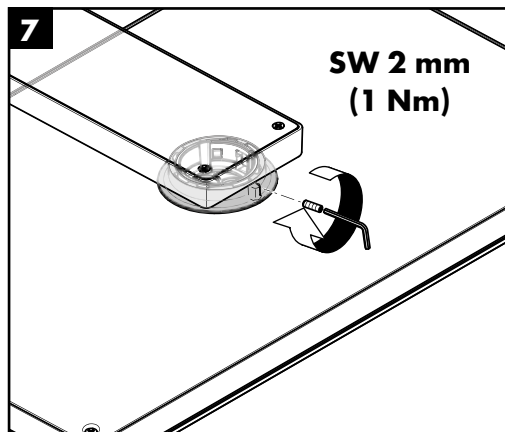
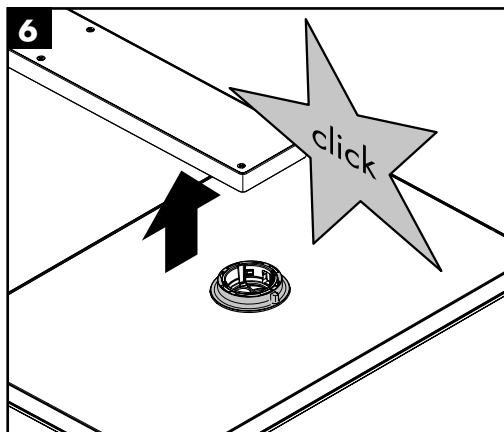

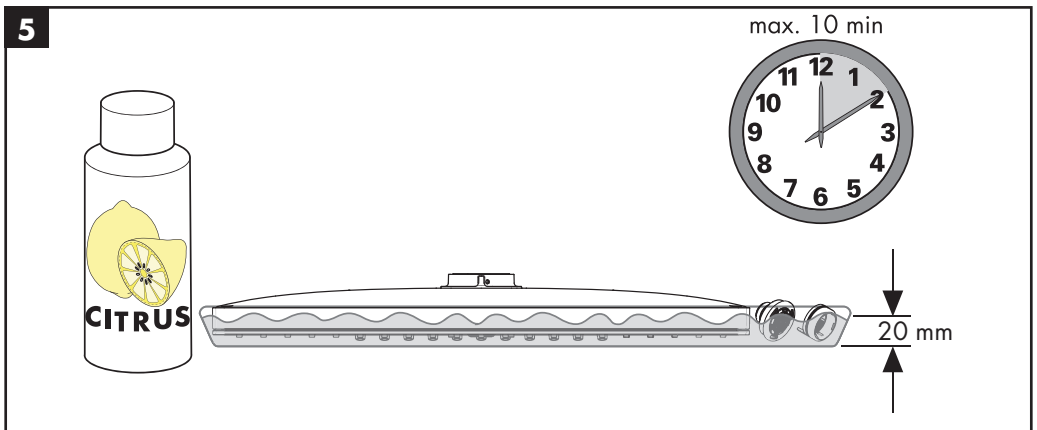
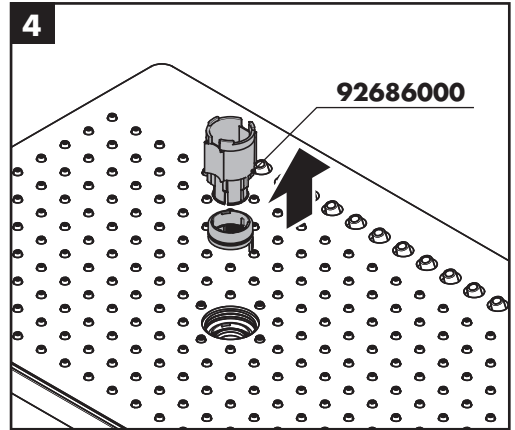
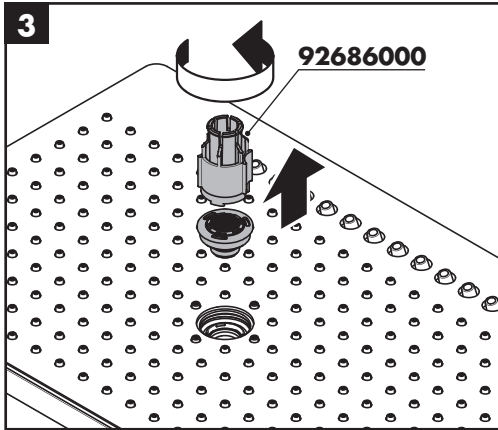
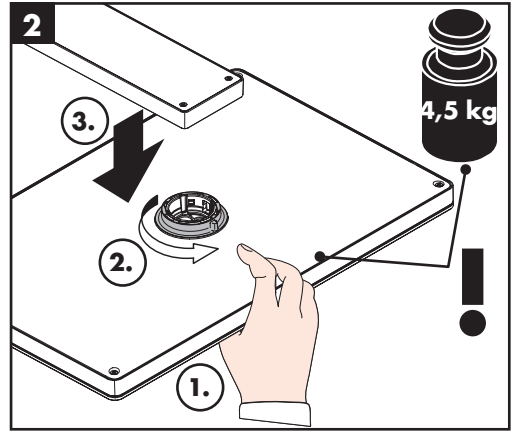
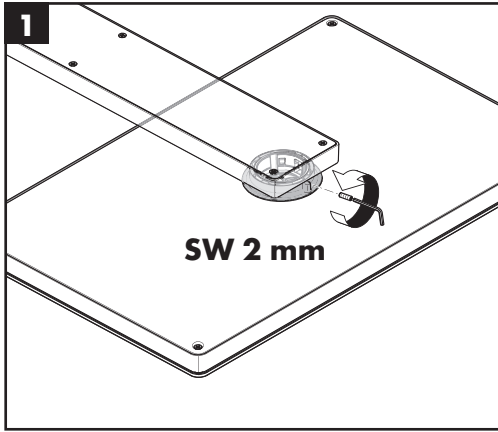

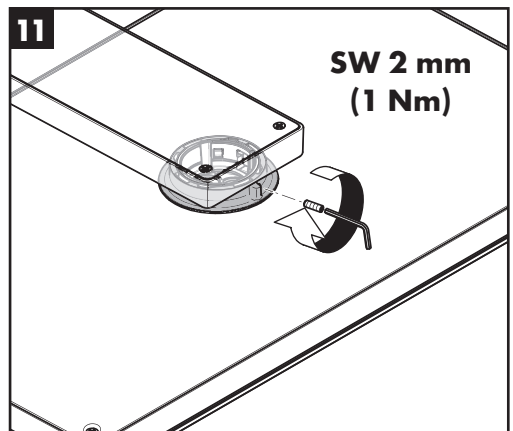
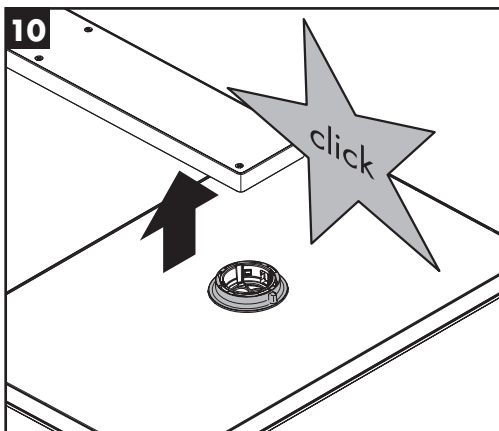
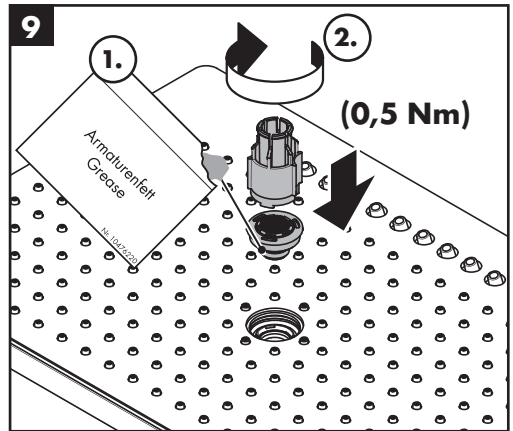
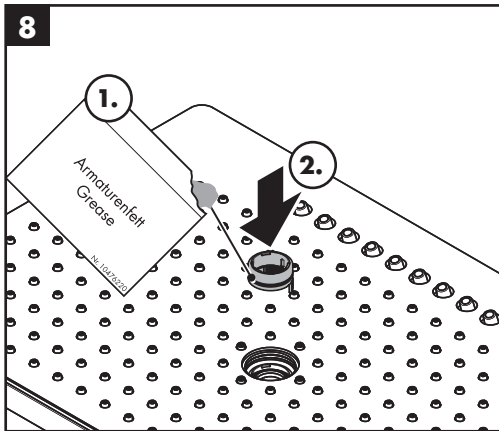
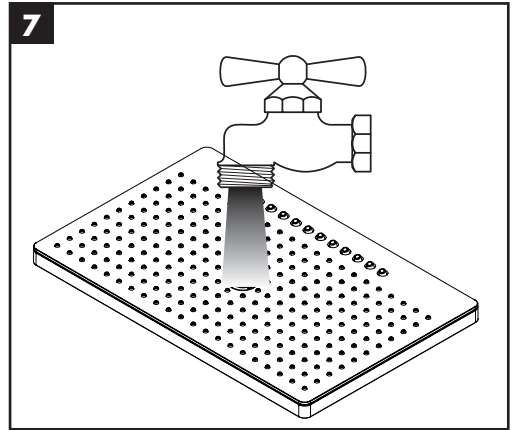
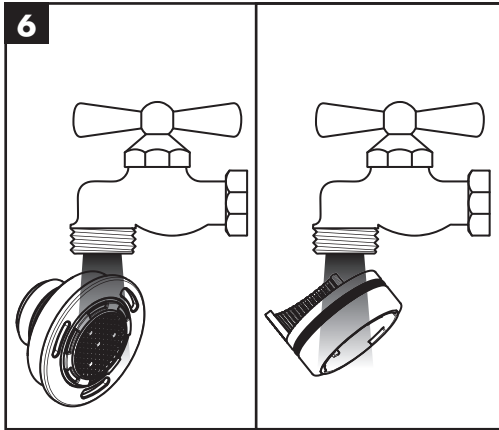
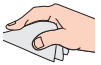

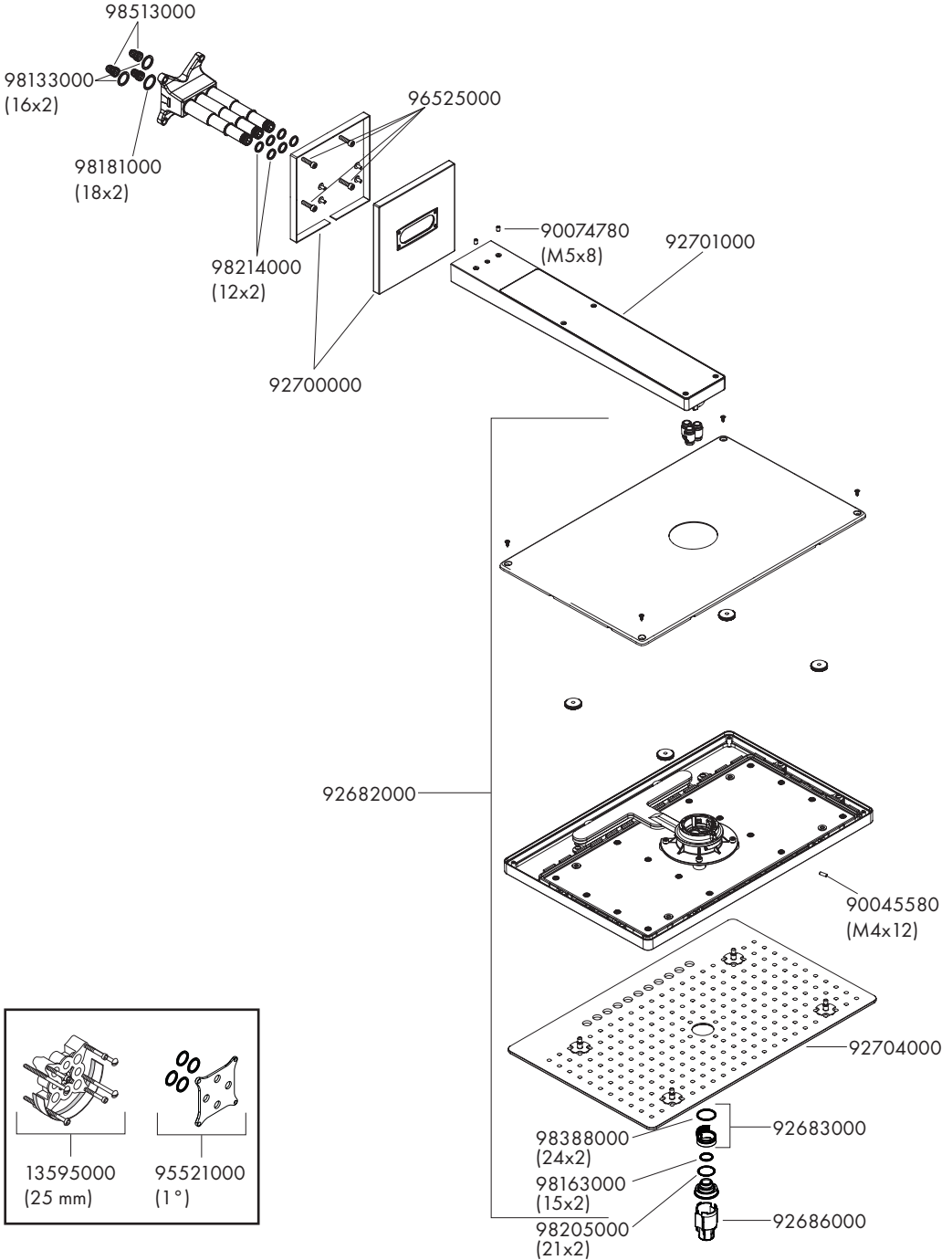

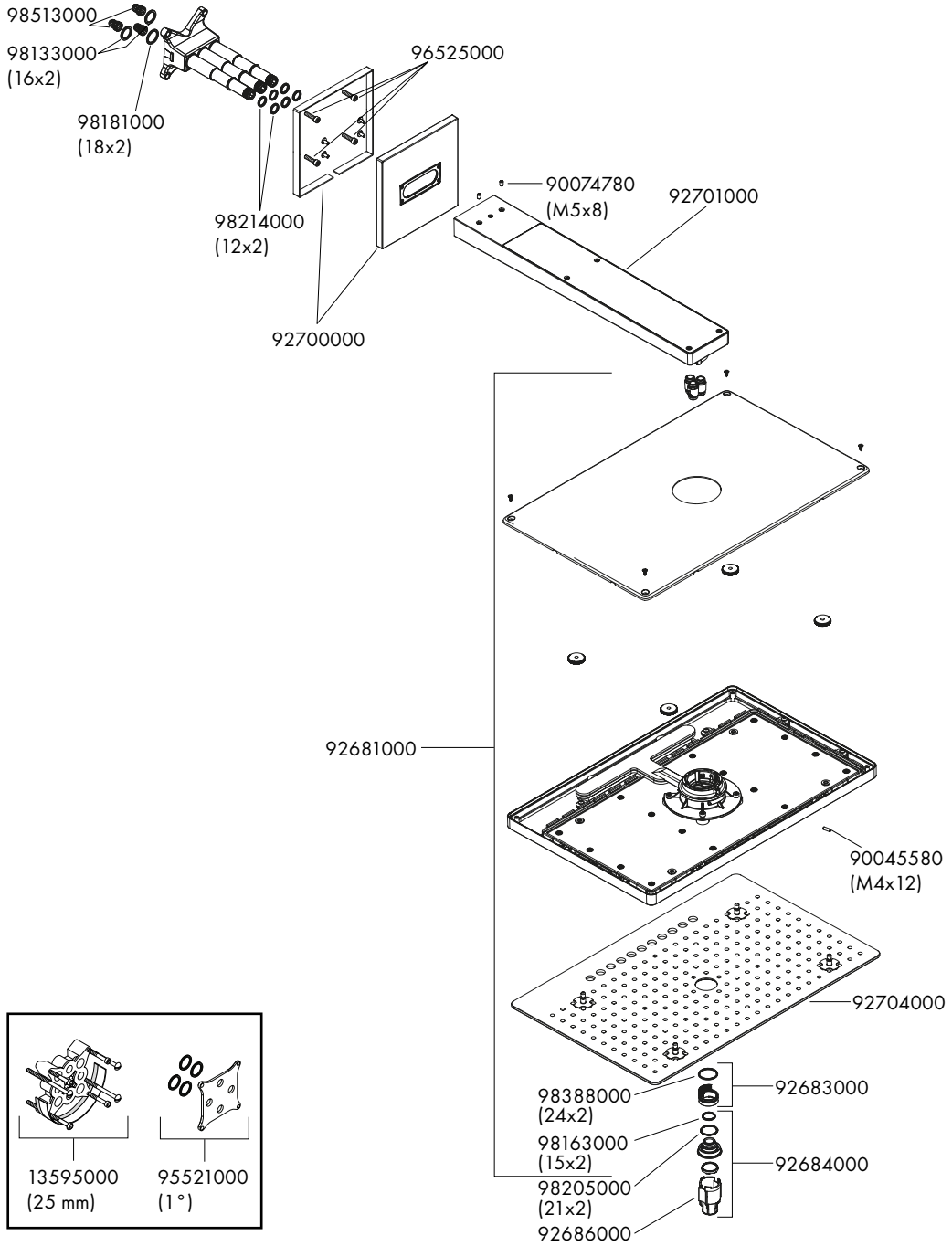



hansgrohe

Hansgrohe · AuestraÙe 5 · 9 · D-77761 Schiltach · Telefon +49 (0) 78 36/51-1282 · Telefax +49 (0) 7836/511440
E-Mail: info@hansgrohe.com · Internet: www.hansgrohe.com

07/2015
9.02858.01