

<b>DE</b>	Gebrauchsanleitung / Montageanleitung	<b>2</b>
<b>FR</b>	Mode d'emploi / Instructions de montage	<b>3</b>
<b>EN</b>	Instructions for use / assembly instructions	<b>4</b>
<b>IT</b>	Istruzioni per l'uso / Istruzioni per Installazione	<b>5</b>
<b>ES</b>	Modo de empleo / Instrucciones de montaje	<b>6</b>
<b>NL</b>	Gebruiksaanwijzing / Handleiding	<b>7</b>
<b>DK</b>	Brugsanvisning / Monteringsvejledning	<b>8</b>
<b>PT</b>	Instruções para uso / Manual de Instalação	<b>9</b>
<b>PL</b>	Instrukcja obsługi / Instrukcja montażu	<b>10</b>
<b>CS</b>	Návod k použití / Montážní návod	<b>11</b>
<b>SK</b>	Návod na použitie / Montážny návod	<b>12</b>
<b>ZH</b>	用户手册 / 组装说明	<b>13</b>
<b>RU</b>	Руководство пользователя / Инструкция по монтажу	<b>14</b>
<b>HU</b>	Használati útmutató / Szerelési útmutató	<b>15</b>
<b>FI</b>	Käyttöohje / Asennusohje	<b>16</b>
<b>SV</b>	Bruksanvisning / Monteringsanvisning	<b>17</b>
<b>LT</b>	Vartotojo instrukcija / Montavimo instrukcijos	<b>18</b>
<b>HR</b>	Upute za uporabu / Uputstva za instalaciju	<b>19</b>
<b>TR</b>	Kullanım kılavuzu / Montaj kılavuzu	<b>20</b>
<b>RO</b>	Manual de utilizare / Instrucțiuni de montare	<b>21</b>
<b>EL</b>	Οδηγίες χρήσης / Οδηγία συναρμολόγησης	<b>22</b>
<b>SL</b>	Navodilo za uporabo / Navodila za montažo	<b>23</b>
<b>ET</b>	Kasutusjuhend / Paigaldusjuhend	<b>24</b>
<b>LV</b>	Lietošanas pamācība / Montāžas instrukcija	<b>25</b>
<b>SR</b>	Uputstvo za upotrebu / Uputstvo za montažu	<b>26</b>
<b>NO</b>	Bruksanvisning / Montasjeveiledning	<b>27</b>
<b>BG</b>	Инструкция за употреба / Ръководство за монтаж	<b>28</b>
<b>SQ</b>	Udhëzuesi i përdorimit / Udhëzime rreth montimit	<b>29</b>
<b>AR</b>	دليل الاستخدام / تعليمات التجميع	<b>30</b>

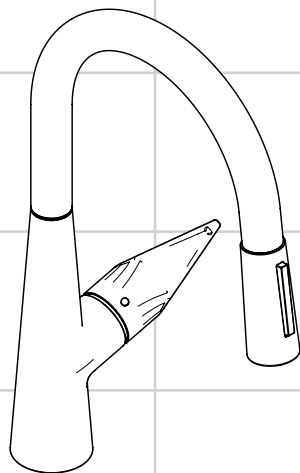

**Talis S 200**

72813000 / 72813800



## Sicherheitshinweise

- ⚠ Bei der Montage müssen zur Vermeidung von Quetsch- und Schnittverletzungen Handschuhe getragen werden.
- ⚠ Große Druckunterschiede zwischen den Kalt- und Warmwasseranschlüssen müssen ausgeglichen werden.

## Montagehinweise

- Vor der Montage muss das Produkt auf Transportschäden untersucht werden. Nach dem Einbau werden keine Transport- oder Oberflächenschäden anerkannt.
- Die Armatur muss nach den gültigen Normen montiert, gespült und geprüft werden.
- Die in den Ländern jeweils gültigen Installationsrichtlinien sind einzuhalten.

## Technische Daten

Betriebsdruck:	max. 1 MPa
Empfohlener Betriebsdruck:	0,1 – 0,5 MPa
Prüfdruck:	1,6 MPa
(1 MPa = 10 bar = 147 PSI)	
Heißwassertemperatur:	max. 70 °C
Empfohlene Heißwassertemperatur:	65 °C
Thermische Desinfektion:	max. 70 °C / 4 min

Hansgrohe Armaturen können in Verbindung mit hydraulisch und thermisch gesteuerten Durchlauferhitzern eingesetzt werden, wenn der Fließdruck mindestens 0,15 MPa beträgt.

Das Produkt ist ausschließlich für Trinkwasser konzipiert!

## Symbolerklärung



Kein essigsäurehaltiges Silikon verwenden!



## Justierung

Einhandmischer mit Warmwasserbegrenzung, Justierung siehe Seite 35. In Verbindung mit Durchlauferhitzern ist eine Warmwassersperre nicht zu empfehlen.



**Maße** (siehe Seite 36)



## Durchflussdiagramm

(siehe Seite 36)

- ① Durchflussleistung Normalstrahl
- ② Durchflussleistung Brausestrahl



## Bedienung

 (siehe Seite 37)

- Auslauf nicht weiter drehen als 360°, da sonst der Schlauch beschädigt werden kann.
- Hansgrohe empfiehlt, morgens oder nach längeren Stagnationszeiten den ersten halben Liter nicht als Trinkwasser zu verwenden.



**Reinigung** (siehe Seite 38) und beiliegende Broschüre



**Wartung** (siehe Seite 38)

Rückflussverhinderer müssen gemäß DIN EN 1717 regelmäßig in Übereinstimmung mit nationalen oder regionalen Bestimmungen auf ihre Funktion geprüft werden (mindestens einmal jährlich).



**Serviceteile** (siehe Seite 39)

XXX = Farbcodierung

000 chrom

800 edelstahl-optik





## ⚠️ Consignes de sécurité

- ⚠️ Lors du montage, porter des gants de protection pour éviter toute blessure par écrasement ou coupure.
- ⚠️ Il est conseillé d'équilibrer les pressions de l'eau chaude et froide.

## Instructions pour le montage

- Avant son montage, s'assurer que le produit n'a subi aucun dommage pendant le transport. Après le montage, tout dommage de transport ou de surface ne pourra pas être reconnu.
- La robinetterie doit être installée, rincée et contrôlée conformément aux normes valables.
- Les directives d'installation en vigueur dans le pays concerné doivent être respectées.

## Informations techniques

Pression de service autorisée:	max. 1 MPa
Pression de service conseillée:	0,1 – 0,5 MPa
Pression maximum de contrôle: (1 MPa = 10 bar = 147 PSI)	1,6 MPa
Température d'eau chaude:	max. 70 °C
Température recommandée:	65 °C
Désinfection thermique:	max. 70 °C / 4 min

Les mitigeurs Hansgrohe fonctionnent également en association à des chauffe-eau à commande hydraulique ou thermique à condition que la pression soit au minimum de 0,15 MPa.

Le produit est exclusivement conçu pour de l'eau potable!

## Description du symbole



Ne pas utiliser de silicone contenant de l'acide acétique!



### Etalonnage

Mitigeur avec limitation de la température: voir la page 35 pour le réglage. Une limitation de la température n'est pas recommandée quand le mitigeur est alimenté par un chauffe-eau instantané.

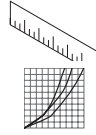

## Dimensions (voir page 36)

## Diagramme du débit

(voir page 36)

- ① Débit Jet de pluie
- ② Débit du jet d'eau



## Instructions de service (voir page 37)

- Le bec ne peut être tourné à plus de 360° sinon le flexible risquerait d'être détérioré.
- Hansgrohe recommande de ne pas utiliser le premier demi-litre le matin ou après une période de stagnation prolongée.



## Nettoyage (voir page 38) et brochure ci-jointe



## Entretien (voir page 38)

Les clapets anti-retour doivent être examinés régulièrement conformément à la norme EN 1717 ou conformément aux dispositions nationales ou régionales quant à leur fonction (au moins une fois par an).



## Pièces détachées (voir pages 39)



XXX = Couleurs  
000 chromé  
800 aspect acier inox



## Montage voir page 31



## Safety Notes

-  Gloves should be worn during installation to prevent crushing and cutting injuries.
-  The hot and cold supplies must be of equal pressures.

## Installation Instructions

- Prior to installation, inspect the product for transport damages. After it has been installed, no transport or surface damage will be honoured.
- The fitting must be installed, flushed and tested after the valid norms.
- The plumbing codes applicable in the respective countries must be observed.

## Technical Data

Operating pressure:	max. 1 MPa
Recommended operating pressure:	0,1 – 0,5 MPa
Test pressure:	1,6 MPa
(1 MPa = 10 bar = 147 PSI)	
Hot water temperature:	max. 70°C
Recommended hot water temp.:	65°C
Thermal disinfection:	max. 70°C / 4 min

Hansgrohe mixers can be used together with hydraulically and thermally controlled continuous flow heaters if the flow pressure is at least 0,15 MPa.

The product is exclusively designed for drinking water!

## Symbol description



Do not use silicone containing acetic acid!



## Adjustment

To adjust the hot water limiter on single lever mixers, please see page 35. Using a hot water limiter in connection with a continuous flow water heater is not recommended.



**Dimensions** (see page 36)



## Flow diagram

(see page 36)

- ① Rate of flow Normal spray
- ② Handspray flow rate



**Operation** (see page 37)

- Do not rotate the spout further than 360° or damage to the hose will result.
- Hansgrohe recommends not to use as drinking water the first half liter of water drawn in the morning or after a prolonged period of non-use.



**Cleaning** (see page 38) and enclosed brochure



**Maintenance** (see page 38)

The non return valves must be checked regularly according to DIN EN 1717 in accordance with national or regional regulations (at least once a year).



**Spare parts** (see page 39)

XXX = Colors



000 chrome plated

800 stainless steel optic





## Indicazioni sulla sicurezza

-  Durante il montaggio, per evitare ferite da schiacciamento e da taglio bisogna indossare guanti protettivi.
-  Attenzione! Compensare le differenze di pressione tra i collegamenti dell'acqua fredda e dell'acqua calda.

## Istruzioni per il montaggio

- Prima del montaggio è necessario controllare che non ci siano stati danni durante il trasporto. Una volta eseguito il montaggio, non verranno riconosciuti eventuali danni di trasporto o delle superfici.
- La rubinetteria deve essere installata, pulita e testata secondo le istruzioni riportate!
- Vanno rispettate le direttive di installazione nazionali vigenti nel rispettivo paese.

## Dati tecnici

Pressione d'uso:	max. 1 MPa
Pressione d'uso consigliata:	0,1 - 0,5 MPa
Pressione di prova:	1,6 MPa
(1 MPa = 10 bar = 147 PSI)	
Temperatura dell'acqua calda:	max. 70°C
Temp. dell'acqua calda consigliata:	65°C
Disinfezione termica:	max. 70°C / 4 min

I miscelatori Hansgrohe possono venire usati con caldaie a „bassa pressione“ se la pressione di flusso è almeno di 0,15 MPa.

Il prodotto è concepito esclusivamente per acqua potabile!

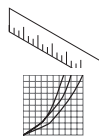

**Ingombri** (vedi pagg. 36)

## Diagramma flusso

(vedi pagg. 36)

- ① Portata di erogazione Getto normale a pioggia
- ② Potenza di erogazione del getto



**Procedura** (vedi pagg. 37)

- Non ruotare la bocca girevole più di 360° o il raccordo verrà danneggiato.
- Hansgrohe raccomanda, di mattina oppure dopo lunghi tempi di stagnazione, di non utilizzare il primo mezzo litro come acqua potabile.



**Pulitura** (vedi pagg. 38) e brochure allegata



**Manutenzione** (vedi pagg. 38)

La valvola di non ritorno deve essere controllata regolarmente come da DIN EN 1717, secondo le normative nazionali e regionali (almeno una volta all'anno).



**Parti di ricambio** (vedi pagg. 39)

- XXX = Trattamento
- 000 cromato
- 800 acciaio inox acciaio

## Descrizione simbolo



Non utilizzare silicone contenente acido acetico!



## Taratura

Per la regolazione del limitatore di erogazione di acqua calda dei miscelatori monocomando, vedi Pagina 35. Un limitatore di erogazione di acqua calda in combinazione con le caldaie istantanee non è consigliabile.



**Montaggio vedi pagg. 31**



## Indicaciones de seguridad

- ⚠ Durante el montaje deben utilizarse guantes para evitar heridas por aplastamiento o corte.
- ⚠ Grandes diferencias de presión en servicio entre agua fría y agua caliente deben equilibrarse.

## Indicaciones para el montaje

- Antes del montaje se debe examinarse el producto contra daños de transporte. Después de la instalación so se reconoce ningún daño de transporte o de superficie.
- El grifo tiene que ser instalado, probado y testado, según las normas en vigor.
- Es obligatorio el cumplimiento de las directrices de instalación vigentes en el país respectivo.

## Datos técnicos

Presión en servicio:	max. 1 MPa
Presión recomendada en servicio:	0,1 - 0,5 MPa
Presión de prueba:	1,6 MPa
(1 MPa = 10 bar = 147 PSI)	
Temperatura del agua caliente:	max. 70 °C
Temp. recomendada del agua caliente:	65 °C
Desinfección térmica:	max. 70 °C / 4 min

Los mezcladores Hansgrohe pueden ser utilizados junto con calentadores continuos de agua que sean manejados de manera hidráulica o térmica, siempre que la presión en servicio ascienda a un mínimo de 0,15 MPa.

El producto ha sido concebido exclusivamente para agua potable.

## Descripción de símbolos



No utilizar silicona que contiene ácido acético!



## Ajuste

Uso como mezclador monomando con limitación del caudal de agua caliente: ver ajuste en pagina 35. En combianción con calentadores instantáneos no es recomendable limitar el caudal de agua caliente.



**Dimensiones** (ver página 36)



**Diagrama de circulación**  
(ver página 36)

- ① Caudal máximo Chorro de lluvia
- ② Caudal chorro de ducha



**Manejo** (ver página 37)

- No girar el caño más de 360° o el flexo podría resultar dañado.
- Hansgrohe recomienda no utilizar el primer medio litro como agua potable por las mañanas o tras un largo periodo de inactividad.



**Limpiar** (ver página 38) y folleto anexo



**Mantenimiento** (ver página 38)

Las válvulas anti-retorno tienen que ser controladas regularmente según la norma DIN EN 1717, en acuerdo con las regulaciones nacionales o regionales (una vez al año, por lo menos).



**Repuestos** (ver página 39)

XXX = Acabados  
000 cromado  
800 acero especial





## Veiligheidsinstructies

- ⚠ Bij de montage moeten ter voorkoming van knel- en snijwonden handschoenen worden gedragen.
- ⚠ Grote drukverschillen tussen de koud- en warmwatertoevoer dienen vermeden te worden.

## Montage-instructies

- Vóór de montage moet het product gecontroleerd worden op transportschade. Na de inbouw wordt geen transport- of oppervlakteschade meer aanvaard.
- Leidingen doorspoelen volgens Norm. De mengkraan vervolgens monteren en controleren.
- De in de overeenkomstige landen geldende installatierichtlijnen moeten nageleefd worden.

## Technische gegevens

Werkdruk: max.	max. 1 MPa
Aanbevolen werkdruk:	0,1 – 0,5 MPa
Getest bij:	1,6 MPa
(1 MPa = 10 bar = 147 PSI)	
Temperatuur warm water:	max. 70°C
Aanbevolen warm water temp.:	65°C
Thermische desinfectie:	max. 70°C / 4 min

Hansgrohe kranen kunnen samen met hydraulisch en thermisch gestuurde geisers gebruikt worden indien de uitstroomdruk min. 0,15 MPa bedraagt.

Het product is uitsluitend ontworpen voor drinkwater!

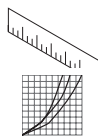

**Maten** (zie blz. 36)

**Doorstroomdiagram**  
(zie blz. 36)

- ① Doorstroomcapaciteit Normale douchestraal
- ② Doorstroomcapaciteit douchestraal



**Bediening** (zie blz. 37)

- De uitloop niet meer dan 360° draaien, de slang kan daardoor beschadigd worden.
- Hansgrohe raadt aan om 's morgens na langere stagnatietijden de eerste halve liter niet als drinkwater te gebruiken.



**Reinigen** (zie blz. 38) en  
bijgevoegde brochure



**Onderhoud** (zie blz. 38)

Keerklappen moeten volgens DIN EN 1717 regelmatig en volgens plaatselijk geldende eisen op het functioneren gecontroleerd worden. (Tenminste een keer per jaar)



**Service onderdelen** (zie blz. 39)

XXX = Kleuren  
000 verchromd  
800 RVS-look

## Symboolbeschrijving



Gebruik geen zuurhoudende silicone!



## Instellen

Eéngreepsmengkranen met warmwaterbegrenzing, instelling zie blz. 35. In combinatie met geisers wordt een warmwaterbegrenzing niet aanbevolen.



**Montage zie blz. 31**



## Sikkerhedsanvisninger

- △ Ved monteringen skal der bruges handsker for at undgå kvæstelser og snitsår.
- △ Større trykforskel mellem koldt og varmt vand bør udjævnes.

## Monteringsanvisninger

- Før monteringen skal produktet kontrolleres for transportskader. Efter monteringen godkendes transportskader eller skader på overfladen ikke længere.
- Ifølge gældende regler, skal armaturet monteres, skylles igennem og afprøves.
- Installationsbestemmelserne, der gælder i det enkelte land, skal overholdes.

## Tekniske data

Driftstryk:	max. 1 MPa
Anbefalet driftstryk:	0,1 – 0,5 MPa
Prøvetryk:	1,6 MPa
(1 MPa = 10 bar = 147 PSI)	
Varmtvandstemperatur:	max. 70 °C
Anbefalet varmtvandstemperatur:	65 °C
Termisk desinfektion:	max. 70 °C / 4 min

Hansgrohe armaturer kan anvendes i forbindelse med hydraulisk- og termiskstyrede gennemstrømningsvandvarmere ved et vandtryk på 0,15 MPa.

Produktet er udelukkende beregnet til drikkevand!

## Symbolbeskrivelse



Der må ikke benyttes eddikesyreholdig silikone!



## Forindstilling

Etgrebsarmaturer med varmtvandsbegrænsning, justering se side 35. I forbindelse med gennemstrømningsvandvarmer anbefales en varmtvandsbegrænsning ikke.



## Målene (se s. 36)



## Gennemstrømningsdiagram (se s. 36)

- ① Gennemstrømningskapacitet Normalstråle
- ② Cirkulationsmængde brusestråle



## Bediening (se s. 37)

- Udløbstudens bør ikke drejes mere end 360°, da slangen ellers beskadiges.
- Hansgrohe anbefaler at den første halve liter om morgenen eller efter længere stagneringstider ikke anvendes som drikkevand.



## Rengøring (se s. 38) og vedlagt brochure



## Service (se s. 38)

Ifølge DIN EN 1717 skal gennemstrømningsbegrænsere i overensstemmelse med nationale regler afprøves regelmæssigt (mindst en gang om året).



## Reserve dele (se s. 39)

XXX = Overflade  
000 Krom  
800 Stainless steel optic







## Avisos de segurança

- ⚠ Durante a montagem devem ser utilizadas luvas de protecção, de modo a evitar ferimentos resultantes de entalamentos e de cortes.
- ⚠ Grandes diferenças entre as pressões das águas quente e fria devem ser compensadas.

## Avisos de montagem

- Antes da montagem deve-se controlar o produto relativamente a danos de transporte. Após a montagem não são aceites quaisquer danos de transporte ou de superfície.
- A misturadora deve ser instalada, purgada e testada de acordo com as normas em vigor.
- A prescrições de instalação válidas nos respetivos países devem ser respeitadas.

## Dados Técnicos

Pressão de funcionamento:	max. 1 MPa
Pressão de func. recomendada:	0,1 – 0,5 MPa
Pressão testada:	1,6 MPa
(1 MPa = 10 bar = 147 PSI)	
Temperatura da água quente:	max. 70 °C
Temp. água quente recomendada:	65 °C
Desinfecção térmica:	max. 70 °C / 4 min

As misturadoras Hansgrohe podem ser utilizadas com esquentadores (de controlo térmico ou hidráulico) desde que a pressão de utilização seja, no mínimo, de 0,15 MPa.

Este produto foi única e exclusivamente concebido para água potável!

## Descrição do símbolo



Não utilizar silicone que contenha ácido acético!



## Afinação

Misturadora monocomando equipada com limitador de temperatura (vide pág. 35). Em combinação com caldeira ou esquentador instantâneo o limitador de água quente não é recomendado.

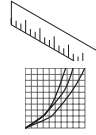

## Medidas (ver página 36)

## Fluxograma (ver página 36)

- ① Caudal operação normal
- ② Caudal do chuveiro



## Funcionamento (ver página 37)

- Não rode a bica mais do que 360° ou irá danificar o tubo flexível.
- A Hansgrohe recomenda a não utilização do primeiro meio litro de água, de manhã ou após longas paragens, para fins de consumo.



## Limpeza (ver página 38) e brochura em anexo



## Manutenção (ver página 38)

As válvulas anti-retorno devem ser verificadas regularmente de acordo com a DIN EN 1717 segundo os regulamentos nacionais ou regionais (pelo menos uma vez por ano).



## Peças de substituição (ver página 39)

XXX = Acabamentos  
000 cromado  
800 aço imaculado ótica





## Wskazówki bezpieczeństwa

- ⚠ Aby uniknąć zranień, takich jak zgniecenia czy przecięcia, podczas montażu należy nosić rękawice.
- ⚠ Znaczne różnice ciśnień na doptywach ciepłej i zimnej wody muszą zostać wyrównane.

## Wskazówki montażowe

- Przed montażem należy skontrolować produkt pod kątem szkód transportowych. Po montażu nie widać żadnych szkód transportowych ani szkód na powierzchni.
- Armatura musi być zamontowana, przepłukana i wypróbowana według obowiązujących norm.
- Należy przestrzegać wytycznych instalacyjnych obowiązujących w danym kraju.

## Dane techniczne

Ciśnienie robocze:	maks. 1 MPa
Zalecane ciśnienie robocze:	0,1 – 0,5 MPa
Ciśnienie próbne: (1 MPa = 10 bary = 147 PSI)	1,6 MPa
Temperatura wody gorącej:	maks. 70 °C
Zalecana temperatura wody gorącej:	65 °C
Dezynfekcja termiczna:	maks. 70 °C / 4 min

Armatura Hansgrohe może być stosowana z przepływowymi podgrzewaczami wody sterowanymi hydraulicznie i termicznie w przypadku, gdy ciśnienie przepływu wynosi co najmniej 0,15 MPa.

Produkt stworzono wyłącznie do wody pitnej!

## Opis symbolu



Nie stosować silikonów zawierających kwas octowy!



## Ustawianie

Mieszacz jednouchwytowy z ogranicznikiem temperatury wody, ustawianie, patrz str. 35. Używanie ogranicznika temperatury wody w połączeniu z przepływowym podgrzewaczem wody nie jest zalecane.



## Montaż patrz strona 31



**Wymiary** (patrz strona 36)



## Schemat przepływu

(patrz strona 36)

- ① Wydajność przepływu Strumień normalny
- ② Wydajność przepływu strumienia prysznica:



## Obsługa

 (patrz strona 37)

- Nie kręcić wylotem bardziej niż o 360°, gdyż może dojść do uszkodzenia węża.
- Hansgrohe zaleca, by z rana lub po dłuższym czasie niekorzystania, pierwsze pół litra wody nie używać jako wody pitnej.



## Czyszczenie

 (patrz strona 38) i

dołączona broszura



## Konserwacja

 (patrz strona 38)

Zgodnie z normą DIN EN 1717, krajowymi i miejscowymi przepisami, działanie zabezpieczeń przed przepływem zwrótnym musi być kontrolowane (przynajmniej raz w roku).





## Części serwisowe

 (patrz strona 39)

XXX = kody wykończenia powierzchni  
000 chrom  
800 stal szlachetna



## Bezpečnostní pokyny

-  Pro zabránění řezným zraněním a pohmožděninám je nutné při montáži nosit rukavice.
-  Je nutné vyrovnat velké rozdíly tlaku mezi přípoji studené a teplé vody.

## Pokyny k montáži

- Před montáží je třeba produkt zkontrolovat, zda nebyl při transportu poškozen. Po zabudování nebudou uznány žádné škody způsobené transportem nebo poškození povrchu.
- Armatura se musí montovat, proplachovat a testovat podle platných norem.
- Je třeba dodržovat montážní pravidla platná v dané zemi.

## Technické údaje

Provozní tlak:	max. 1 MPa
Doporučený provozní tlak:	0,1 – 0,5 MPa
Zkušební tlak:	1,6 MPa
(1 MPa = 10 bar = 147 PSI)	
Teplota horké vody:	max. 70 °C
Doporučená teplota horké vody:	65 °C
Teplná desinfekce:	max. 70 °C / 4 min

Armatury Hansgrohe je možno používat v kombinaci s hydraulicky a tepelně řízenými průtokovými ohřivači v případě, že tlak činí minimálně 0,15 MPa.

Výrobky Hansgrohe jsou vhodné pro přímý kontakt s pitnou vodou.

## Popis symbolů



Nepoužívat silikon s obsahem kyseliny octové!



## Nastavení

Páková baterie s omezením horké vody, seřízení viz. str. 35. Ve spojení s průtokovými ohřivači nedoporučujeme používat uzávěr teplé vody.

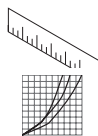

## Rozměry (viz strana 36)

## Diagram průtoku

(viz strana 36)

- ① Průtok Normální proud
- ② Průtokové množství sprchy



## Ovládání (viz strana 37)

- Výtok neotáčet více než 360°, mohlo by dojít k poškození hadice.
- Hansgrohe doporučuje ráno nebo po delších přestávkách nepoužívat prvního půl litru jako pitnou vodu.



## Čištění (viz strana 38) a přiložená brožura



## Údržba (viz strana 38)

U zpětných ventilů se musí podle DIN EN 1717 v souladu s národními nebo regionálními předpisy testovat jejich funkčnost (alespoň jednou ročně).



## Servisní díly (viz strana 39)

XXX = kód povrchové úpravy  
000 chrom  
800 nerezová ocel





## **Bezpečnostné pokyny**

- △ Pri montáži musíte nosiť rukavice, aby ste predišli pomliaždeninám a rezným poraneniam.
- △ Veľké rozdiely v tlaku medzi prípojkami studenej a teplej vody musia byť vyrovnané.

## **Pokyny pre montáž**

- Pred montážou musíte produkt skontrolovať, či nebol počas transportu poškodený. Po zabudovaní nebudú uznané žiadne škody spôsobené transportom alebo poškodenia povrchu.
- Armatúra sa musí montovať, preplachovať a testovať podľa platných noriem.
- Je potrebné dodržiavať smernice o inštalácii, ktoré sú práve teraz platné v krajinách.

## **Technické údaje**

Prevádzkový tlak:	max. 1 MPa
Doporučený prevádzkový tlak:	0,1 – 0,5 MPa
Skúšobný tlak:	1,6 MPa (1 MPa = 10 bar = 147 PSI)
Teplota teplej vody:	max. 70 °C
Doporučená teplota teplej vody:	65 °C
Termická dezinfekcia:	max. 70 °C / 4 min

Batérie Hansgrohe môžete používať v spojení s hydraulickými a tepelne ovládanými prietokovými ohrievačmi, ak je tlak minimálne 0,15 MPa.

Výrobok je koncipovaný výhradne pre pitnú vodu!

## **Popis symbolov**



Nepoužívať silikón s obsahom kyseliny octovej!



## **Nastavenie**

Páková batéria s obmedzením teplej vody, nastavenie viď.str. 35. V spojení s prietokovými ohrievačmi sa uzáver teplej vody neodporúča.



**Rozmery** (viď strana 36)



## **Diagram prietoku**

(viď strana 36)

- ① Prietok Normálny prúd
- ② Prietokové množstvo prúdu vody v sprche



## **Obsluha** (viď strana 37)

- Odpad nepretáčať viac ako o 360°, lebo môže dôjsť k poškodeniu hadice.
- Hansgrohe odporúča ráno a po dlhších dobách odstávky nepoužiť prvého pol litra vody ako pitnú vodu.



**Čistenie** (viď strana 38) a priložená brožúra



## **Údržba** (viď strana 38)

Pri spätných ventiloch sa musí podľa DIN EN 1717 v súlade s národnými alebo regionálnymi predpismi testovať ich funkčnosť (aspoň raz ročne).



## **Servisné diely** (viď strana 39)

XXX = kód povrchovej úpravy

000 chróm

800 ušľachtilá oceľ





## 安全技巧

△ 装配时为避免挤压和切割受伤，必须戴上手套。

△ 冷热水管间过大的压力差必须予以平衡。

## 安装提示

- 安装前必须检查产品是否受到运输损害。安装后将不认可运输损害或表面损伤。
- 必须按照现行的规定安装，冲洗和测试产品。
- 请遵守当地国家现行的安装规定。

## 技术参数

工作压强:	最大 1 MPa
推荐工作压强:	0,1 0,5 MPa
测试压强:	1,6 MPa
(1 MPa = 10 bar = 147 PSI)	
热水温度:	最大 70°C
推荐热水温度:	65°C
热力消毒:	最大 70°C / 4 分钟

如果水压达到0,15 MPa以上，汉斯格雅双手柄龙头可以和液压式或热控式连续流热水器一起使用。该产品专为饮用水设计！

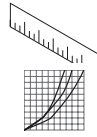

大小 (参见第 36 页)

流量示意图  
(参见第 36 页)

- ① 流速 普通水流
- ② 花洒出水流量



操作 (参见第 37 页)

- 水嘴旋转不可超过360，否则会导致软管受损。
- 汉斯格雅建议，清晨或在水流长时间停滞时，前半升水不作饮用水使用。



清洗 (参见第 38 页) 并附有小手册



保养 (参见第 38 页)

单向阀必须在符合国家或当地的法律的情况下按照DIN EN 1717定期检查（至少一年一次）。



备用零件 (参见第 39 页)

XXX = 颜色代码  
000 镀铬  
800 不锈钢表面

## 符号说明



请勿使用含有乙酸的硅！



## 调节



带有热水控制器的单手柄龙头的调节方法，参见第 35 页。如果与即热式热水器一起使用，则不建议使用止热水装置。



安装 参见第 31 页



## Указания по технике безопасности

-  Во время монтажа следует надеть перчатки во избежание прищемления и порезов.
-  донного клапа. Перед установкой смесителя необходимо регулировочными кранами выровнять давление холодной и горячей воды при помощи вентилей регулирующих подачу воды в квартиру.

## Указания по монтажу

- Перед монтажом следует проверить изделие на предмет повреждений при перевозке. После монтажа претензии о возмещении ущерба за повреждения при перевозке или повреждения поверхностей не принимаются.
- Смеситель должен быть смонтирован по действующим нормам и в соответствии с настоящей инструкцией, проверен на герметичность и безупречность работы.
- Необходимо соблюдать требования по монтажу, действующие в соответствующих странах.

## Технические данные

Рабочее давление:	не более. 1 МПа
Рекомендуемое рабочее давление:	0,1 – 0,5 МПа
Давления:	1,6 МПа
(1 МПа = 10 bar = 147 PSI)	
Температура горячей воды:	не более. 70 °С
Рекомендуемая темп. гор. воды:	65 °С
Термическая дезинфекция:	не более. 70 °С / 4 мин

Арматуры Hansgrohe могут использоваться в комбинации с проточными нагревателями с гидравлическим и термическим управлением, если давление истечения составляет не менее 0,15 МПа.

Изделие предназначено исключительно для питьевой воды!

## Описание символов



Не применяйте силикон, содержащий уксусную кислоту.



## Подгонка

Однорычажный смеситель имеет ограничитель расхода горячей воды (см. Стр. 35: юстировка). В комбинации с проточными нагревателями не рекомендуется установка блокировка горячей воды!

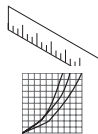

## Размеры (см. стр. 36)

## Схема потока

(см. стр. 36)

- ① Пропускная способность Нормальная струя
- ② Пропускная способность струи душа



## Эксплуатация (см. стр. 37)

- Не поворачивайте излив более, чем на 360°, поскольку иначе можно повредить шланг.
- Hansgrohe рекомендует по утрам либо после длительного перерыва в использовании не использовать первые поллитра воды для питья.



## Очистка (см. стр. 38) и прилагаемая брошюра



## Техническое обслуживание (см. стр. 38)

Защита обратного тока должна регулярно проверяться (минимум один раз в год) по стандарту DIN EN 1717 или в соответствии с национальными или региональными нормативами





## Комплект (см. стр. 39)

XXX = Код цвета поверхности  
000 хром  
800 сталь





## Biztonsági utasítások

-  A szerelésnél a zúzódások és vágási sérülések elkerülése érdekében kesztyűt kell viselni.
-  A hidegvíz- és a melegvíz-csatlakozások közötti nagy nyomáskülönbséget kikell egyenlíteni!

## Szerelési utasítások

- A szerelés előtt ellenőrizni kell, hogy a terméknek nincs-e szállítási sérülése. Beépítés után a szállítási-vagy felületi sérüléseket nem ismerik el.
- A csaptelepet az érvényben lévő előírásoknak megfelelően kell felszerelni, átöblíteni és ellenőrizni.
- Az egyes országokban érvényes installációs irányelveket be kell tartani.

## Műszaki adatok

Üzemi nyomás:	max. 1 MPa
Ajánlott üzemi nyomás:	0,1 – 0,5 MPa
Nyomáspróba:	1,6 MPa
(1 MPa = 10 bar = 147 PSI)	
Forróvíz hőmérséklet:	max. 70 °C
Forróvíz javasolt hőmérséklete:	65 °C
Termikus fertőtlenítés:	max. 70 °C / 4 perc

A Hansgrohe csaptelepek hidraulikus és termikus vezérlésű átfolyós melegítővel kapcsolatban is használhatóak, ha az átfolyó nyomás legalább 0,15 MPa.

A terméket kizárólag ivóvízhez tervezték!

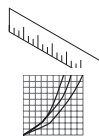

**Méretet** (lásd a 36. oldalon)

## Átfolyási diagram

(lásd a 36. oldalon)

- ① Átfolyási teljesítmény Normálsugár
- ② Átfolyási teljesítmény, zuhansugár



**Használat** (lásd a 37. oldalon)

- A kifolyót ne fordítsa 360°-nál tovább, mert különben a tömlő megsérülhet.
- A Hansgrohe azt ajánlja, hogy hosszabb állási idő után az első fél liter vizet ne használja ivóvízként.



**Tisztítás** (lásd a 38. oldalon) és mellékelt bróssúrával



**Karbantartás** (lásd a 38. oldalon)

A visszafolyásgátlók működése a DIN EN 1717 szabványnak megfelelően, a nemzeti vagy területi rendelkezésekkel összhangban, évente egyszer ellenőrizendő!



**Tartozékok** (lásd a 39. oldalon)

XXX = Színkódok  
000 króm  
800 acéloptika

## Szimbólumok leírása



Ne használjon ecetsavtartalmú szilikont!

## Beállítás

Az egykaros, melegvíz-korlátozóval ellátott keverő csaptelep beállítását lásd a 35. oldalon. Az átfolyó rendszerű vízmelegítőknél nem ajánlott a melegvíz-korlátozó.



**Szerelés lásd a 31. oldalon**



## Turvallisuusohjeet

- Asennuksessa on käytettävä käsiineitä puristumien ja viiltojen aiheuttamien tapaturmien estämiseksi.
- Suuret paine-erot kylmä- ja kuumavesiliitännöiden välillä on tasattava.

## Asennusohjeet

- Ennen asennusta on tarkastettava tuotteen mahdolliset kuljetusvahingot. Asennuksen jälkeen kuljetus- ja pintavaurioita ei hyväksytä.
- Kaluste on asennettava, huuhdeltava ja tarkastettava voimassa olevien määräysten mukaisesti.
- Jokaisessa maassa on noudatettava siellä päteviä asennusohjeita.

## Tekniset tiedot

Käyttöpaine:	maks. 1 MPa
Suosittelut käyttöpaine:	0,1 – 0,5 MPa
Koestuspaine:	1,6 MPa
(1 MPa = 10 bar = 147 PSI)	
Kuuman veden lämpötila:	maks. 70 °C
Kuuman veden suosituslämpötila:	65 °C
Lämpödesinfektio:	maks. 70 °C / 4 min

Hansgrohe kalusteita voi käyttää hydraulisesti tai termisesti ohjattujen läpivirtauskuumentimien yhteydessä, jos virtauspaine on vähintään 0,15 MPa.

Tuote on suunniteltu käytettäväksi ainoastaan juomaveden kanssa!

## Merkin kuvaus



Älä käytä etikkahappopitoista silikonia!



## Säätö

Yksivipuinen sekoittaja lämpimän veden rajoituksella, katso säätö sivulta 35. Lämpimän veden rajoitusta ei suositella läpivirtauskuumentimen yhteydessä.



## Mitat (katso sivu 36)



## Virtausdiagrammi

(katso sivu 36)

- Lämpivirtausmäärä Normaalisuihku
- Lämpivirtausmäärä



## Käyttö (katso sivu 37)

- Älä käännä juoksuputkea enempää kuin 360°, koska muuten letku voi vahingoittua.
- Hansgrohe suosittelee, että ensimmäistä puolta litraa ei käytetä juomavetenä aamuisin eikä silloin, kun laitetta ei ole käytetty pitkään aikaan.



## Puhdistus (katso sivu 38) ja oheinen esite



## Huolto (katso sivu 38)

Vastaventtiilien toiminta on tarkastettava säännöllisesti paikallisten ja kansallisten määräysten mukaisesti (DIN EN 1717, vähintään kerran vuodessa).



## Varaosat (katso sivu 39)

XXX = Värikoodi

000 kromi

800 inox-optinen







## ! Säkerhetsanvisningar

- △ Handskar ska bäras under monteringsarbetet så att man kan undvika kläm- och skärskadorna.
- △ Stora tryckskillnader mellan anslutningarna för varmt och kallt vatten måste utjämnas.

## Monteringsanvisningar

- Det måste undersökas om produkten har transportskador innan den monteras. Efter monteringen accepteras inga transport- eller ytskiktsskador.
- Armaturen måste installeras, genomspolas och testas enligt gällande föreskrifter.
- De installationsriktlinjer som gäller i länderna ska följas.

## Tekniska data

Driftstryck:	max. 1 MPa
Rek. driftstryck:	0,1 – 0,5 MPa
Tryck vid provtryckning: (1 MPa = 10 bar = 147 PSI)	1,6 MPa
Varmvattentemperatur:	max. 70 °C
Rek. varmvattentemp.:	65 °C
Termisk desinfektion:	max. 70 °C / 4 min

Hansgrohe blandare kan användas tillsammans med hydrauliskt och termiskt styrda varmvattenberedare när flödestrycket uppgår till minst 0,15 MPa.

Produkten är enbart avsedd för dricksvatten!

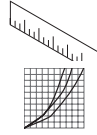

**Måtten** (se sidan 36)

## Flödesschema

(se sidan 36)

- ① Genomströmningmängd Normalstråle
- ② Flödeskapacitet duschstråle



**Hantering** (se sidan 37)

- Vrid inte blandaren mer än 360° eftersom slangen annars kan skadas.
- Hansgrohe rekommenderar att den första halvlitern inte används som dricksvatten på morgonen eller efter längre perioder utan användning.



**Rengöring** (se sidan 38) och medföljande broschyr



**Skötsel** (se sidan 38)

Backventilens funktion måste kontrolleras regelbundet enligt nationella eller regionala bestämmelser i enlighet med DIN EN 1717 (minst en gång per år).



**Reservdelar** (se sidan 39)

XXX = Färgkodning

000 krom

800 rostfri-optik

## Symbolförklaring



Använd inte silikon som innehåller ättiksyra!



## Justering

Enhandsblandare med varmvattenreglering, justering se sidan 35. Tillsammans med varmvattenberedare rekommenderas inte en varmvattenreglering.



**Montering se sidan 31**



## Saugumo technikos nurodymai

- △ Apsaugai nuo užspaudimo ir įsijovimo montavimo metu mūvėkite pirštines.
- △ Turi būti išlyginti šalto ir karšto slėgio nelygumai.

## Montavimo instrukcija

- Prieš montuojant būtina patikrinti, ar gaminys nebuvo pažeistas transportavimo metu. Sumontavus pretenzijos dėl transportavimo ir paviršiaus pažeidimų nepriimamos.
- Maišytuvus privalo būti montuojamas ir išbandomas pagal veikiančias normas ir šią instrukciją.
- Laikykitės atitinkamoje šalyje galiojančių direktyvų dėl įrengimo.

## Techniniai duomenys

Darbinis slėgis: ne daugiau kaip 1 MPa

Rekomenduojamas slėgis: 0,1 – 0,5 MPa

Bandomasis slėgis: 1,6 MPa

(1 MPa = 10 barų = 147 PSI)

Karšto vandens temperatūra: ne daugiau kaip 70°C

Rekomenduojama karšto vandens temperatūra: 65°C

Terminis dezinfekavimas: ne daugiau kaip 70°C / 4 min

„Hansgrohe“ maišytuvai gali būti naudojami su hidrauliškai ir termiškai reguliuojamais momentiniais šildikliais, kai vandens slėgis mažesnis kaip 0,15 MPa.

Produktas skirtas tik geriamajam vandeniui!



## Išmatavimai (žr. psl. 36)



## Pralaidumo diagrama

(žr. psl. 36)

- ① Vandens pralaidumas Normali srovė
- ② Vandens pralaidumas. Dušo srovė



## Eksploatacija (žr. psl. 37)

- Nesukite čiaupo daugiau kaip 360°, nes galite pažeisti žarną.
- Naudojant po ilgesnės pertraukos, „Hansgrohe“ rekomenduoja pirmo pusės litro vandens nevertoti kaip geriamojo.



## Valymas (žr. psl. 38) ir pridama brošiūra



## Techninis aptarnavimas (žr. psl. 38)

Atbulinio vožtuvo apsauga privalo būti tikrinama reguliariai (mažiausiai kartą per metus) pagal DIN EN1717 arba pagal galiojančias nacionalines arba regionines normas.



## Atsarginės dalys (žr. psl. 39)

XXX = Spalva

000 chrom

800 plienas

## Simbolio aprašymas



Nenaudokite silikono, kurio sudėtyje yra acto rūgšties!



## Reguliavimas

Vienos rankenėlės maišytuvus turi karšto vandens ribotuvą (nustatymą žr. psl. 35). Naudojant momentinį šildiklį karšto vandens ribotuvus nerekomenduojamas.



## Montavimas žr. psl. 31



## Sigurnosne upute

- ⚠ Prilikom montaže se radi sprječavanja prignječenja i posjekotina moraju nositi rukavice.
- ⚠ Velika razlika u pritisku između vruće i hladne vode mora biti izbalansirana.

## Upute za montažu

- Prije montaže mora se provjeriti je li proizvod oštećen prilikom transporta. Nakon ugradnje se ne priznaju nikakve reklamacije koje se odnose na površinska i transportna oštećenja.
- Cijevi moraju biti postavljene, isprane i testirane prema važećim normama.
- Obvezno se moraju uvažiti propisi o instalacijama koji vrijede u dotičnoj zemlji.

## Tehnički podaci

Najveći dopušteni tlak:	tlak 1 MPa
Preporučeni tlak:	0,1 – 0,5 MPa
Probni tlak:	1,6 MPa
(1 MPa = 10 bar = 147 PSI)	
Temperatura vruće vode:	tlak 70 °C
Preporučena temperatura vruće vode:	65 °C
Termička dezinfekcija:	tlak 70 °C / 4 min

Hansgrohe armature mogu se koristiti u kombinaciji sa hidraulički i termički kontroliranim protočnim bojlerima ukoliko tlak iznosi najmanje 0,15 MPa

Proizvod je koncipiran isključivo za pitku vodu!

## Opis simbola



Nemojte koristiti silikon koji sadrži octenu kiselinu!



## Regulacija

Za namještanje jednoručnih miješalica s limiterom tople vode vidi str. 35. U kombinaciji s protočnim bojlerima nije preporučljiva primjena sustava za blokiranje dotoka tople vode.

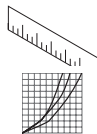

## Mjere (pogledaj stranicu 36)

### Dijagram protoka (pogledaj stranicu 36)

- ① Protok vode Normalni mlaz
- ② Protočni mlaz



## Upotreba (pogledaj stranicu 37)

- Slavina se ne smije zavrtiti više od 360 ° jer bi se u protivnom mogla oštetiti cijev
- Hansgrohe preporuča da ujutro ili nakon duljeg nekorištenja prvih 1/2 litre vode ne upotrebljavate za piće.



## Čišćenje (pogledaj stranicu 38) i priložena brošura



## Održavanje (pogledaj stranicu 38)

Ispravnost nepovratnog ventila mora se redovito provjeravati prema standardu DIN EN 1717 i u skladu sa važećim propisima (najmanje jednom godišnje).



## Rezervni dijelovi (pogledaj stranicu 39)

XXX = Boje  
000 krom  
800 plemeniti čelik



## Sastavljanje pogledaj stranicu 31



## ⚠ Güvenlik uyarıları

- ⚠ Montaj esnasında ezilme ve kesilme gibi yaralanmaları önlemek için eldiven kullanılmalıdır.
- ⚠ Sıcak ve soğuk su bağlantıları arasında büyük basınç farklılıkları varsa, bu basınç farklılıklarının dengelenmesi gerekir.

## Montaj açıklamaları

- Montaj işleminden önce ürün nakliye hasarları yönünden kontrol edilmelidir. Montaj işleminden sonra nakliye veya yüzey hasarları için sorumluluk üstlenilmemektedir.
- Batarya monte edilmeli, geçerli normlardan sonra akis testi yapılmalıdır.
- Ülkelerde geçerli kurulum yönetmeliklerine riayet edilmelidir.

## Teknik bilgiler

İşletme basıncı:	azami 1 MPa
Tavsiye edilen işletme basıncı:	0,1 – 0,5 MPa
Kontrol basıncı:	1,6 MPa
(1 MPa = 10 bar = 147 PSI)	
Sıcak su sıcaklığı:	azami 70 °C
Tavsiye edilen su ısısı:	65 °C
Termik dezenfeksiyon:	azami 70 °C / 4 dak

Hansgrohe bataryaları, akış basıncı en az 0,15 MPa olursa hidrolik ve termik kumandalı şofbenlerle bağlantılı olarak kullanılabilir.

Ürün sadece şebeke suyu için tasarlanmıştır!

## Simge açıklaması



Asetik asit içeren silikon kullanmayın!



## Ayarlama

Sıcak su sınırlayıcı özelliğine sahip tek kollu bataryanın ayarlanması için 35. sayfaya bakınız. Bir sürekli akışlı su ısıtıcısı ile birlikte kullanılırsa sıcak su sınırlayıcısı önerilmez.

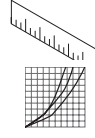

## Ölçüleri (Bakınız sayfa 36)

### Akış diyagramı

(Bakınız sayfa 36)

- ① Debisi Normal duş
- ② Duş su akışındaki debi



## Kullanımı (Bakınız sayfa 37)

- Aksi takdirde hortum zarar görebileceği için çıkışı 360°'den fazla döndürmeyin.
- Hansgrohe sabahları uzun durgunluk süresi sonrasında ilk yarım litre suyun içme suyu olarak kullanılmamasını önerir.



## Temizleme (Bakınız sayfa 38) ve birlikte verilen broşür



## Bakım (Bakınız sayfa 38)

DIN EN 1717 ve ulusal standartlar doğrultusunda Çek valfler düzenli olarak kontrol edilmelidir. ( en az yılda bir kez)



## Yedek Parçalar (Bakınız sayfa 39)

XXX = Renkler



000 krom

800 paslanmaz çelik - optik





## Instrucțiuni de siguranță

-  La montare utilizați mănuși pentru evitarea contuziunilor și tăierii mâinilor.
-  Diferențele de presiune mari între alimentarea cu apă rece și apă caldă trebuie echilibrate.

## Instrucțiuni de montare

- Înainte de instalare verificați, dacă produsul prezintă deteriorări de transport. După instalare garanția nu acoperă deteriorările de transport și cele de suprafață.
- Bateria trebuie montată, clătită și verificată conform normelor în vigoare.
- Respectați reglementările referitoare la instalare valabile în țara respectivă.

## Date tehnice

Presiune de funcționare:	max. 1 MPa
Presiune de funcționare recomandată:	0,1 – 0,5 MPa
Presiune de verificare:	1,6 MPa (1 MPa = 10 bar = 147 PSI)
Temperatura apei calde:	max. 70 °C
Temperatura recomandată a apei calde:	65 °C
Dezinfecție termică:	max. 70 °C / 4 min

Bateriile Hansgrohe pot fi utilizate cu boiler instant cu comandă termică sau hidraulică dacă presiunea apei de alimentare este de min. 0,15 MPa.

Produsul este destinat exclusiv pentru apă potabilă.

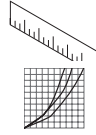

**Dimensiuni** (vezi pag. 36)

## **Diagrama de debit**

(vezi pag. 36)

- ① Debit de apă jet normal
- ② Debitul de apă al dușului stropitor



**Utilizare** (vezi pag. 37)

- Nu rotiți pipa mai mult de 360°, altfel riscați deteriorarea furtunului.
- Hansgrohe vă recomandă, ca dimineața sau după perioade mai lungi de pauză să nu folosiți prima jumătate de litru de apă pentru băut.



**Curățare** (vezi pag. 38) și broșura alăturată



**Întreținere** (vezi pag. 38)

Supapele antiretur trebuie verificate regulat conform DIN EN 1717 și standardele naționale sau regionale (cel puțin o dată pe an).



**Piese de schimb** (vezi pag. 39)

XXX = cod de culori

000 crom

800 oțel inox

## Descrierea simbolurilor



Nu utilizați silicon cu conținut de acid acetic!



## Reglare

Baterie monocomadă cu limitarea apei calde, pentru reglare vezi pag. 35. Dacă conectați bateria la un boiler instant nu vă recomandăm instalarea unui opritor de apă caldă.



**Montare vezi pag. 31**



## ⚠ Υποδείξεις ασφαλείας

- ⚠ Για να αποφύγετε τραυματισμούς κατά τη συναρμολόγηση πρέπει να φοράτε γάντια.
- ⚠ Οι διαφορές της πίεσης μεταξύ της σύνδεσης κρύου και ζεστού νερού θα πρέπει να αντισταθμίζονται.

## Οδηγίες συναρμολόγησης

- Πριν τη συναρμολόγηση πρέπει να εξεταστεί το προϊόν για ζημιές μεταφοράς. Μετά την εγκατάσταση δεν αναγνωρίζονται ζημιές από τη μεταφορά ή επιφανειακές ζημιές.
- Η μπαταρία πρέπει να τοποθετηθεί, να πλυθεί και να ελεγχθεί με βάση τους ισχύοντες κανόνες υδραυλικής τέχνης
- Θα πρέπει να τηρούνται οι οδηγίες εγκατάστασης που ισχύουν σε κάθε κράτος.

## Τεχνικά Χαρακτηριστικά

Λειτουργία πίεσης:	έως 1 MPa
Συνιστώμενη λειτουργία πίεσης:	0,1 – 0,5 MPa
Πίεση ελέγχου:	1,6 MPa
(1 MPa = 10 bar = 147 PSI)	
Θερμοκρασία ζεστού νερού:	έως 70 °C
Συνιστώμενη θερμοκρασία ζεστού νερού:	65 °C
Θερμική απολύμανση:	έως 70 °C / 4 min

Οι βάνες Hansgrohe μπορούν να συνδυαστούν με ταχυθερμοσίφωνες υδραυλικού και θερμικού ελέγχου, όταν η πίεση ροής αριθμεί τουλάχιστον 0,15 MPa.

Το προϊόν έχει σχεδιαστεί αποκλειστικά για πόσιμο νερό!

## Περιγραφή συμβόλων



Μην χρησιμοποιείτε σιλικόνη που περιέχει οξικό οξύ!



## Ρύθμιση

Για να προσαρμόσετε το δοσομετρητή ζεστού νερού σε αναμεικτικές μπαταρίες, παρακαλούμε δείτε τη ρύθμιση στη σελ. 35. Δεν συνιστάται η διάταξη φραγής ζεστού νερού σε συνδυασμό με ταχυθερμοσίφωνα.



## Διαστάσεις (βλ. σελίδα 36)

## Διάγραμμα ροής

(βλ. σελίδα 36)

- ① Κατανάλωση νερού Κανονική δέσμη νερού
- ② Κατανάλωση νερού σε δέσμη καταιονισμού στα



## Χειρισμός (βλ. σελίδα 37)

- Μην περιστρέφετε την αποχέτευση πέραν των 360°, καθώς μπορεί να προκληθεί βλάβη στο σωλήνα παροχής.
- Η Hansgrohe συνιστά το πρωί ή μετά από μεγάλα χρονικά διαστήματα αχρησίας να μην χρησιμοποιείτε το πρώτο μισό λίτρο νερό σαν πόσιμο.



## Καθαρισμός (βλ. σελίδα 38) και συνημμένο φυλλάδιο



## Συντήρηση (βλ. σελίδα 38)

Οι βαλβίδες αντεπιστροφής πρέπει να ελέγχονται τακτικά ως προς τη λειτουργία τους, σύμφωνα με το πρότυπο DIN EN 1717, σε σχέση με τους ισχύοντες εθνικούς ή τοπικούς κανόνες (το ελάχιστο μια φορά το χρόνο).



## Ανταλλακτικά (βλ. σελίδα 39)

XXX = Χρώματα  
000 Επιχρωμωμένο  
800 οπτική ανοξείδωτο χάλυβα





## ⚠ Varnostna opozorila

- ⚠ Pri montaži je treba nositi rokavice, da se preprečijo poškodbe zaradi zmečkanja ali urezov.
- ⚠ Velike razlike v tlaku med priključkom za mrzlo in priključkom za toplo vodo je potrebno izravnati.

## Instructions pour le montage

- Pred montažo je treba izdelek preveriti glede morebitnih transportnih poškodb. Po vgradnji transportne ali površinske poškodbe ne bodo več priznane.
- Armature je potrebno montirati, splakniti in testirati v skladu z veljavnimi predpisi.
- Upoštevati je treba pravilnike o inštalacijah, ki veljajo v posamezni državi.

## Tehnični podatki

Delovni tlak:	maks. 1 MPa
Priporočeni delovni tlak:	0,1 – 0,5 MPa
Preskusni tlak:	1,6 MPa
(1 MPa = 10 bar = 147 PSI)	
Temperatura tople vode:	maks. 70 °C
Priporočena temperatura tople vode:	65 °C
Termična dezinfekcija:	maks. 70 °C / 4 min

Armature Hansgrohe lahko uporabljate v povezavi s hidravlično in termično uravnanimi pretočnimi grelniki, če je pretočni tlak najmanj 0,15 MPa.

Proizvod je zasnovan izključno za sanitarno vodo!

## Opis simbola



Ne smete uporabiti silikona, ki vsebuje ocetno kislino!



## Justiranje

Enoročne mešalne baterije z omejevalnikom tople vode, za justiranje glejte stran 35. V povezavi s pretočnimi grelniki zapora tople vode ni priporočljiva.



**Mere** (glejte stran 36)



## Diagram pretoka

(glejte stran 36)

- ① Pretok vode Normalen curek
- ② Pretok vode curek prhe



## Upravljanje

 (glejte stran 37)

- Izliva ne obračajte za več kot 360°, saj lahko sicer poškodujete gibko cev.
- Hansgrohe priporoča, da zjutraj ali po daljšem času stagnacije prvega pol litra vode ne uporabite kot pitno vodo.



**Čiščenje** (glejte stran 38) in priložena brošura



## Vzdrževanje

 (glejte stran 38)

Delovanje protipovratnega ventila je potrebno v skladu z DIN EN 1717 in skladno z državnimi in regionalnimi določili redno testirati (najmanj enkrat letno).



## Rezervni deli

 (glejte stran 39)

XXX = Barve

000 krom

800 videz legiranega jekla



**Montaža Glejte stran 31.**



## ⚠ Ohutusjuhised

- ⚠ Kandke paigaldamisel muljumis- ja löikevigastuste vältimiseks kindaid.
- ⚠ Kui külma ja kuumu vee ühenduste surve on väga erinev, tuleb need tasakaalustada.

## Paigaldamisjuhised

- Enne paigaldamist tuleb toodet kontrollida transpordikahjustuste osas. Pärast paigaldamist ei tunnustata enam transpordi- või pinnakahjustuste kaebuseid.
- Seadmestiku paigaldamine, läbipesu ja kontrollimine peab toimuma vastavalt kehtivatele normidele.
- Vastavas riigis kehtivaid paigalduseeskirju tuleb järgida.

## Tehnilised andmed

Töörõhk	maks. 1 MPa
Soovitatav töörõhk:	0,1 – 0,5 MPa
Kontrollsurve:	1,6 MPa
(1 MPa = 10 baari = 147 PSI)	
Kuumu vee temperatuur:	maks. 70 °C
Soovitatav kuumu vee temperatuur:	65 °C
Termiline desinfitatsioon:	maks. 70 °C / 4 min

Hansgrohe segisteid võib kasutada koos hüdrauliliselt ja termiliselt juhitavate boileritega, kui vee surve on vähemalt 0,15 MPa.

Toode on ette nähtud eranditult joogivee jaoks!

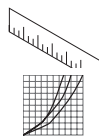

## Mõõtude (vt lk 36)

## Läbivooludiagramm (vt lk 36)

- ① Läbivool tavajuga
- ② Duši läbivool



## Kasutamine (vt lk 37)

- Väljavooluosa ei või keerata üle 360°, kuna see võib voolikut kahjustada.
- Hansgrohe soovib mitte kasutada esimest poolt liitrit hommikuti või pärast pikemat seisakuaga joogiveena.



## Puhastamine (vt lk 38) ja kaasasolev brošüür



## Hooldus (vt lk 38)

Tagasilöögiklappide toimimist tuleb kooskõlas riiklike ja regionaalsete määrustega regulaarselt kontrollida vastavalt standardile DIN EN 1717 (vähemalt kord aastas).



## Varuosad (vt lk 39)

XXX = Värvikood  
000 kroom  
800 roostevaba optik

## Sümbolite kirjeldus



Ärge kasutage äädikhapet sisaldavat silikooni!

## Reguleerimine

Ühe juhtkangiga segisti kuumu vee piiraja reguleerimise kohta vt lk 35. Läbivoolu boilerite puhul pole reguleerimine soovitatav.





## Paigaldamine vt lk 31





## Drošības norādes

-  Montāžas laikā, lai izvairītos no saspiedumiem un iegriezumiem, nepieciešams nēsāt cimdus.
-  Jāizlīdzina spiediena atšķirības starp aukstā un karstā ūdens pievadiem.

## Norādījumi montāžai

- Pirms montāžas nepieciešams pārbaudīt, vai produktam transportēšanas laikā nav radušies bojājumi. Pēc iebūvēšanas bojājumi, kas radušies transportēšanas laikā, vai virsmas bojājumi netiek atzīti.
- Jaucējkrāns jāmontē, jāskalo un jāpārbauda atbilstoši spēkā esošajām normām.
- Jāievēro attiecīgās valstīs spēkā esošās montāžas prasības.

## Tehniskie dati

Darba spiediens:	maks. 1 MPa
ļeicamais darba spiediens:	0,1 – 0,5 MPa
Pārbaudes spiediens:	1,6 MPa
(1 MPa = 10 bar = 147 PSI)	
Karstā ūdens temperatūra:	maks. 70 °C
ļeicamā karstā ūdens temperatūra:	65 °C
Termiskā dezinfekcija :	maks. 70 °C / 4 min

Hansgrohe jaucējkrānus var izmantot kombinācijā ar hidrauliski un termiski vadāmiem caurteces sildītājiem, ja plūsmas spiediens ir vismaz 0,15 MPa.

Izstrādājums ir paredzēts tikai dzeramajam ūdenim!

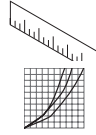

**Izmērus** (skat. 36. lpp.)

**Caurplūdes diagramma**  
(skat. 36. lpp.)

- ① Caurteces intensitāte Standarta strūkla
- ② Caurteces intensitāte dušas strūklai



**Lietošana** (skat. 37. lpp.)

- Snīpi negriez tālāk par 360°, jo tādējādi var tikt bojāta žūtene.
- Hansgrohe iesaka no rīta vai pēc ilgākiem pārtraukumiem nelietot pirmo puslitr ūdens dzeršanai.



**Tīršana** (skat. 38. lpp.) un klāt pievienotais buklets



**Apkope** (skat. 38. lpp.)

Regulāri jāpārbauda pretvārsta funkcija saskaņā ar DIN EN 1717 saistībā ar nacionālajiem vai vietējiem noteikumiem (vismaz vienreiz gadā).



**Rezerves daļas** (skat. 39. lpp.)

XXX = Krāsas  
000 hroma  
800 tērauda

## Simbolu nozīme



Neizmantot silikonu, kas satur etiķskābi!



## Ieregulēšana

Viensvārs jaucējkrāns ar siltā ūdens ierobežošanu, ieregulēšanu skat. 35. lpp. Kombinācijā ar caurteces sildītāju karstā ūdens ierobežošanu nav ieteicama.



**Montāža skat. 31. lpp.**



## Sigurnosne napomene

- △ Prilikom montaže se radi sprečavanja prignječenja i posekotina moraju nositi rukavice.
- △ Velika razlika u pritisku između vruće i hladne vode mora biti izbalansirana.

## Instrukcije za montažu

- Pre montaže se mora proveriti da li je proizvod oštećen pri transportu. Nakon ugradnje se ne priznaju nikakve reklamacije koje se odnose na površinska i transportna oštećenja.
- Armatura mora biti postavljena, isprana i testirana prema važećim normama.
- Treba se pridržavati propisa koji u određenim zemljama važe za instalacije.

## Tehnički podaci

Radni pritisak:	maks. 1 MPa
Preporučeni radni pritisak:	0,1 – 0,5 MPa
Probni pritisak:	1,6 MPa
(1 MPa = 10 bar = 147 PSI)	
Temperatura vruće vode:	maks. 70 °C
Preporučena temperatura vruće vode:	65 °C
Termička dezinfekcija:	maks. 70 °C / 4 min

Hansgrohe armature se mogu koristiti u kombinaciji s hidraulički i termički kontrolisanim protočnim bojlerima ukoliko pritisak iznosi najmanje 0,15 MPa.

Proizvod je koncipiran isključivo za pijaću vodu!

## Opis simbola



Nemojte koristiti silikon koji sadrži sirćetnu kiselinu!



## Podešavanje

Za podešavanje jednoručnih mešača sa ograničivačem tople vode vidi str. 35. U kombinaciji sa protočnim bojlerima ne preporučuje se primena sistema za blokiranje dotoka tople vode.

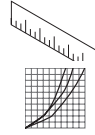

**Mere** (vidi stranu 36)

**Dijagram protoka**  
(vidi stranu 36)

- ① Protok vode Normalni mlaz
- ② Protočni mlaz



**Rukovanje** (vidi stranu 37)

- Ispusno crevo se ne sme uvrtati više od 360°, jer bi se u protivnom moglo oštetiti.
- Hansgrohe preporučuje da ujutru ili nakon dužeg nekorišćenja prvih pola litre vode ne koristite za piće.



**Čišćenje** (vidi stranu 38) i priložena brošura



**Održavanje** (vidi stranu 38)

Ispravno funkcionisanje nepovratnog ventila se mora redovno proveravati prema standardu DIN EN 1717 i u skladu s važećim nacionalnim ili regionalnim propisima (najmanje jednom godišnje).



**Rezervni delovi** (vidi stranu 39)

XXX = Oznake boja

000 hrom



800 dezen plemeniti čelik



**Montaža vidi stranu 31**



## Sikkerhetshenvisninger

-  Bruk hansker under montasjen for å unngå klem- og kuttskader.
-  Store trykkdifferanser mellom kaldt- og varmtvannstilkoblinger skal utlignes.

## Montagehenvisninger

- Før montasjen skal produktet sjekkes for transportskader. Etter monteringen aksepteres ikke noen transport- eller overflateskader.
- Armaturen skal monteres, spyles og sjekkes iht. gyldige standarder.
- Gjeldende retningslinjer for rørleggerarbeid i de enkelte land skal følges.

## Tekniske data

Driftstrykk	maks. 1 MPa
Anbefalt driftstrykk:	0,1 – 0,5 MPa
Prøvetrykk	1,6 MPa
(1 MPa = 10 bar = 147 PSI)	
Varmtvannstemperatur	maks. 70°C
Anbefalt temperatur for varmt vann	65°C
Termisk desinfisering:	maks. 70°C / 4 min

Armaturer fra Hansgrohe kan brukes sammen med hydraulisk og termisk strypte gjennomstrømningsovner når gjennomstrømningsstrykket er på minst 0,15 MPa.

Produktet er utelukkende designet for drikkevann!

## Symbolbeskrivelse



Ikke bruk silikon som inneholder eddiksyre!



## Justering

Enhåndblanderbatteri med varmtvannsbegrensning. For justering se side 35. I forbindelse med en gjennomstrømningsovn er det ikke anbefalt med varmtvannsbegrensning.

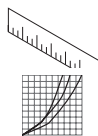

## Mål (se side 36)

## Gjennomstrømningsdiagram (se side 36)

- ① Gjennomstrømningsytelse Normalstråle
- ② Gjennomstrømningsytelse dusjstråle



## Betjening (se side 37)

- Ikke vri utløpet mer enn 360°, ellers blir slangen skadet.
- Om morgen og etter lengre stagnasjonstider anbefaler Hansgrohe å ikke bruke den første halvliteren som drikkevann.



## Rengjøring (se side 38) og vedlagt borsyre



## Vedlikehold (se side 38)

Funksjonen til returløpssperren skal iht. DIN EN 1717 og i samsvar med de nasjonale og lokale forskrifter sjekkes regelmessig (DIN 1988 en gang i året).



## Serviceledere (se side 39)

XXX = Fargekode

000 krom

800 rustfritt stål optikk



## Montasje se side 31



## Указания за безопасност

- ⚠ При монтажа трябва да се носят ръкавици, за да се избегнат наранявания поради притискане или порязване.
- ⚠ Големите разлики в налягането между изводите за студената и топлата вода трябва да се изравняват.

## Указания за монтаж

- Преди монтажа продуктът трябва да се провери за транспортни щети. След монтажа не се признават транспортни или повърхностни щети.
- Арматурата трябва да се монтира, промие и провери в съответствие с валидните норми.
- Трябва да бъдат спазвани валидните в съответните страни предписания за инсталиране.

## Технически данни

Работно налягане:	макс. 1 МПа
Препоръчително работно налягане:	0,1 – 0,5 МПа
Контролно налягане:	1,6 МПа
(1 МПа = 10 bar = 147 PSI)	
Температура на горещата вода:	макс. 70 °C
Препоръчителна температура на горещата вода:	65 °C
Термична дезинфекция:	макс. 70 °C / 4 мин

Арматурите на Hansgrohe могат да се използват във връзка с хидравлично и термично управляеми проточни нагреватели, ако хидравличното налягане е минимум 0,15 МПа.

Продуктът е разработен само за питейна вода!

## Описание на символите



Не използвайте силикон, съдържащ оцетна киселина!



## Юстиране

Смесител с една ръкохватка с ограничител за топлата вода, юстирането вижте на стр. 35. Във връзка с проточни нагреватели не се препоръчва блокировка за топлата вода.



## Размери (вижте стр. 36)



## Диаграма на потока (вижте стр. 36)

- ① Мощност на потока Нормална струя
- ② Мощност на потока разпръскваща струя



## Обслужване (вижте стр. 37)

- Не завъртайте изпускателния отвор на повече от 360°, тъй като в противен случай може да се повреди маркучът.
- Hansgrohe препоръчва, сутрин и след по-продължително спиране първият половин литър да не се използва като питейна вода.



## Почистване (вижте стр. 38) и приложена брошура



## Поддръжка (вижте стр. 38)

Съгласно DIN EN 1717 функционирането на приспособленията за предотвратяване на обратния поток трябва редовно да се проверява в съответствие с националните или регионални изисквания (поне веднъж годишно).



## Сервизни части (вижте стр. 39)

XXX = Цветово кодиране

000 хром



800 оптика на благородна стомана



## Монтаж вижте стр. 31



## Udhëzime sigurie

-  Për të evituar lëndimet e pickimeve ose të prerjeve gjatë procesit të montimit duhet që të vishni doreza.
-  Ndryshimet e mëdha të presionit mes lidhjeve të ujit të ftohtë dhe atij të ngrohtë duhen ekuilibruar.

## Udhëzime për montimin

- Përpara montimit duhet që produkti të kontrollohet për dëmtime nga transporti. Pas instalimit nuk do të njihet asnjë dëmtim nga transporti ose dëmtim i sipërfaqes.
- Armatura duhet montuar, shpërlarë dhe kontrolluar në bazë të normave të vlefshme.
- Duhet të respektohen linjat udhëzuese të instalimit, të vlefshme për vendet respektive.

## Të dhëna teknike

Presioni gjatë punës	maks. 1 MPa
Presioni i rekomanduar:	0,1 – 0,5 MPa
Presioni për provë:	1,6 MPa
(1 MPa = 10 bar = 147 PSI)	
Temperatura e ujit të ngrohtë	maks. 70°C
Temperatura e rekomanduar e ujit të ngrohtë:	65°C
Dezinfektim Termik:	maks. 70°C / 4 min

Armaturat e Hansgrohe mund të përdoren në kombinim me ngrohës elektrikë të ujit të drejtuar në mënyrë hidraulike ose termike nëse presioni i rrjedhjes është minimumi 0,15 MPa.

Produkti është projektuar ekskluzivisht për ujë të pijshëm!

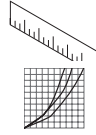

**Përmasat** (shih faqen 36)

**Diagrami i qarkullimit**  
(shih faqen 36)

- ① Kapaciteti i rrjedhjes Curril normal
- ② Kapaciteti i rrjedhjes i currilit të spërkatëses



**Përdorimi** (shih faqen 37)

- Dalja nuk duhet rrotulluar më shumë se 360°, sepse mund të dëmtohet tubi.
- Hansgrohe rekomandon që në mëngjes ose pas periudhave të gjata që gjysmë litri i parë mos të pihet



**Pastrimi** (shih faqen 38) dhe broshura bashkëngjitur



**Mirëmbajtja** (shih faqen 38)

Penguesit e rrjedhjes në drejtim të kundërt duhen kontrolluar rregullisht në bazë të normave DIN EN 1717 konform normave nacionale dhe regionale (së paku një herë në vit).



**Pjesë ndërrimi** (shih faqen 39)

XXX = Kodimi me anë të ngjyrave  
000 krom  
800 optikë çeliku

## Përshkrimi i simbolit



Mos përdorni silikon që në përbërje ka acid acetik.



### Justimi

Rubinet me ujë të përzier me kufizim të ujit të ngrohtë, justimi shih faqen 35. Në kombinim me ngrohësit elektrikë të ujit nuk rekomandohet bllokada e ujit të ngrohtë.



## Montimi shih faqen 31



### أبعاد (راجع صفحة 36)

#### رسم للصرف (راجع صفحة 36)

- ① معدل التدفق رشاش عادي
- ② قدرة تدفق الماء من الدش

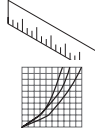

### التشغيل (راجع صفحة 37)

- لا تقم بتدوير الصنبور أكثر من 360 درجة. وإلا تسبب ذلك في تلف الخرطوم.
- ننصح شركة هانزجرهوي Hansgrohe بعدم استخدام أول نصف لتر من الماء لغرض الشرب وذلك في الصباح أو بعد توقف استخدام الماء لفترات طويلة نسبياً.



### التنظيف (راجع صفحة 38) والكتيب المرفق



### الصيانة (راجع صفحة 38)



يجب فحص صمام عدم الرجوع بصفة منتظمة حسب المواصفة DIN EN 1717 وذلك طبقاً للوائح الوطنية أو الإقليمية (مرة واحد سنوياً على الأقل).

### قطع الغيار (راجع صفحة 39)



XXX = الألوان  
000 كروم  
800 مظهر الإستنليس ستيل

### ⚠️ تنبيهات الأمان

- ⚠️ يجب إرتداء قفازات لليد أثناء التركيب لتجنب حدوث أخطار الإنحشار أو الجروح.
- ⚠️ يجب أن يكون تيار الماء الساخن والماء البارد متعادلين في الضغط.

### تعليمات التركيب

- قبل القيام بعملية التركيب، يجب فحص المنتج للتأكد من خلوه من أيه تلفيات ناجمة عن النقل. بعد القيام بعملية التركيب، لن يتم الاعتراف بوجود أية تلفيات سطحية أو تلفيات ناجمة عن عملية النقل.
- يجب تركيب الوصلة واستخدامها واختبارها وفقاً للمعايير المعمول بها.
- يجب مراعاة القواعد الخاصة بالتركيب وأعمال السباكة وفقاً للوائح الخاصة بكل بلد.

### المواصفات الفنية

ضغط التشغيل: الحد الأقصى 1 ميجابيسكال  
ضغط التشغيل الموصى به: 0,1 - 0,5 ميجابيسكال  
ضغط الاختبار: 1,6 ميجابيسكال  
(1 ميجابيسكال = 10 بار = 147 PSI)  
درجة حرارة الماء الساخن: الحد الأقصى 70°C  
درجة الحرارة الموصى بها للماء الساخن: 65°C  
تعميم حراري: الحد الأقصى 4 / 70°C الدقيقة

يمكن استخدام خلطات هانزجرهوي مع سخانات تدفق الماء ذات التحكم الهيدروليكي والحراري. مع ضغط تدفق لا يقل عن 0,15 ميجابيسكال.  
المنتج مخصص فقط لماء الشرب!

### وصف الرمز

هام! لا تستخدم السليكون الذي يحتوي على أحماض!



### الضبط



لضبط محدد الماء الساخن في الخلطات ذات المقبض الواحد، يرجى الرجوع إلى صفحة 35. ولا ينصح إجراء أي ضبط عند استخدام سخان مياه ذي تدفق مستمر.



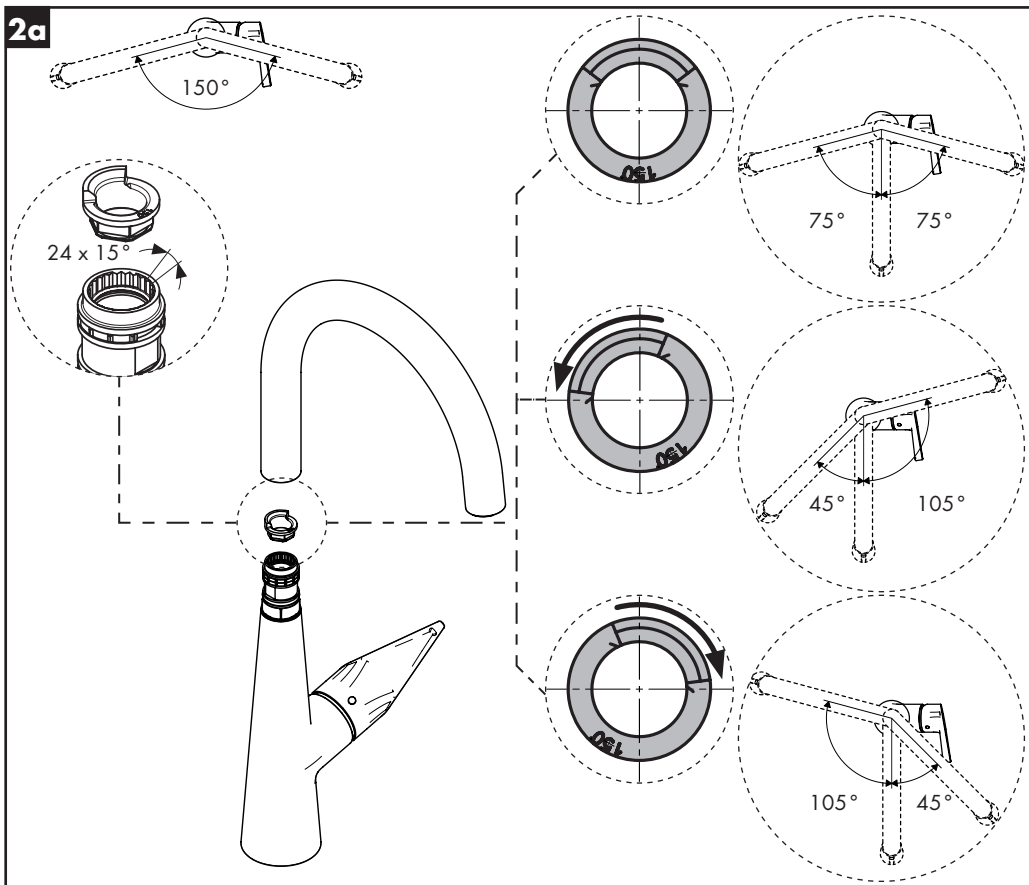
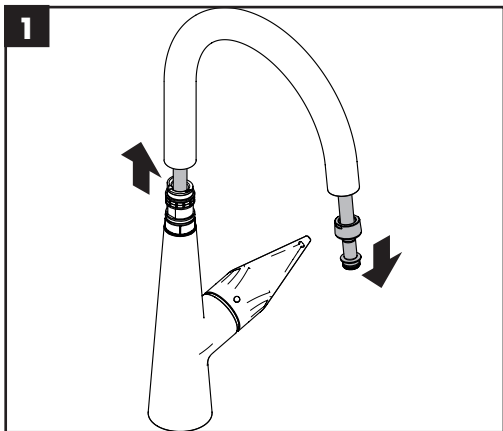



**2b**

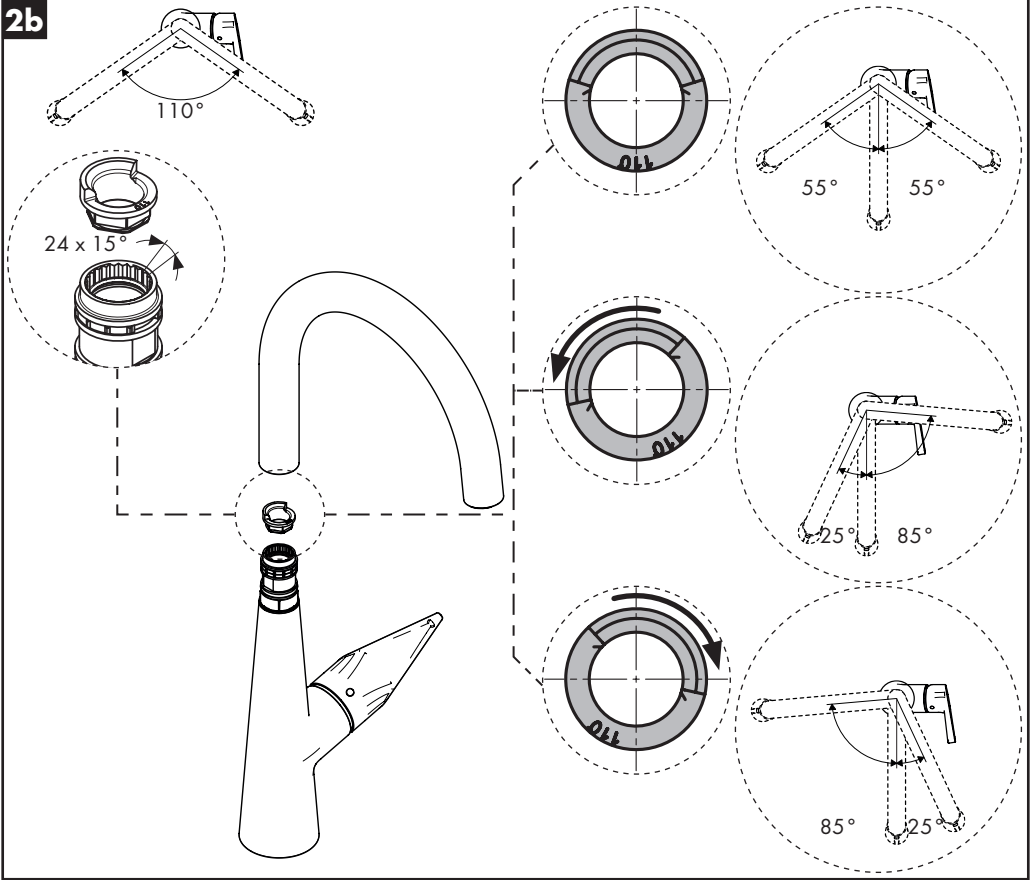

**3**

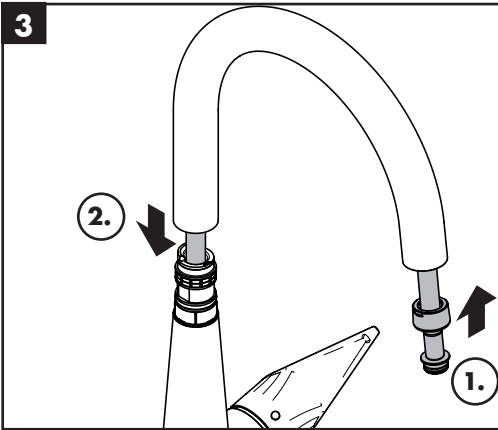

**4a**

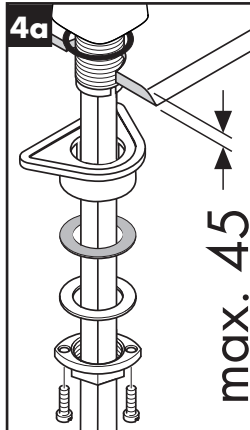

**4b**

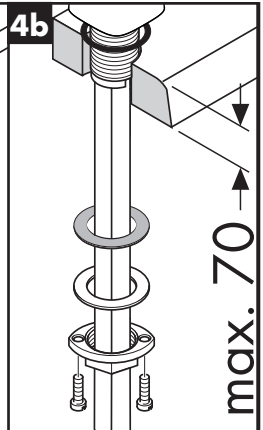



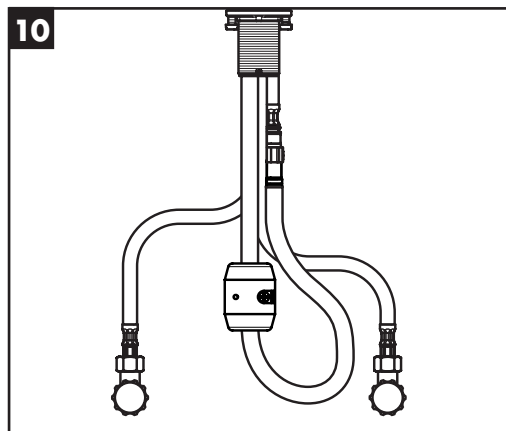
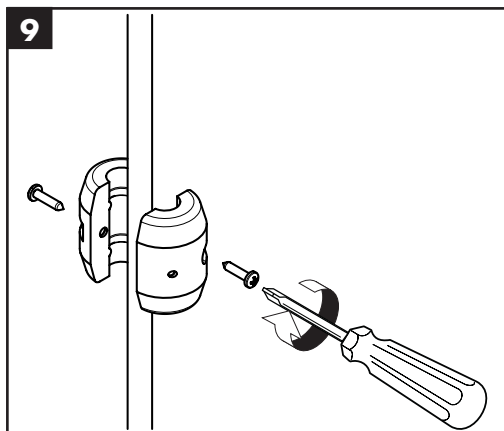
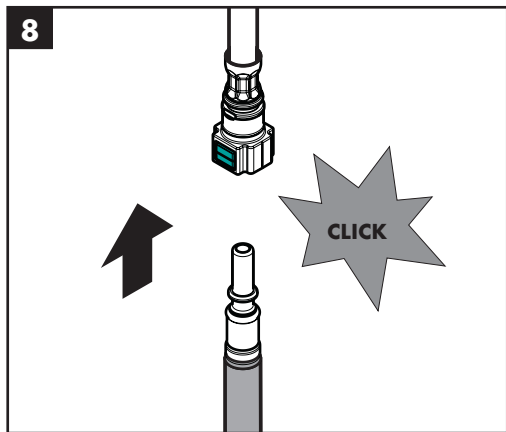
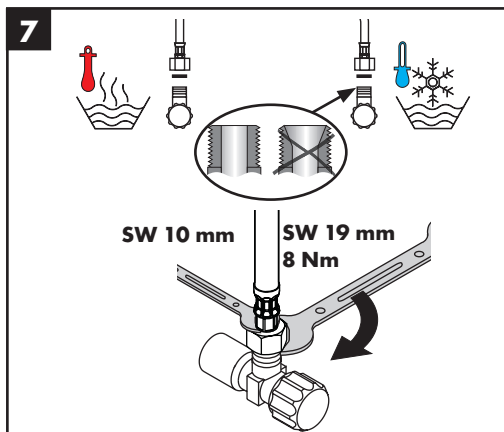
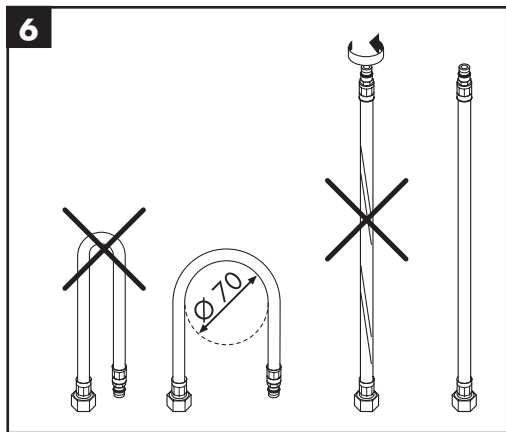
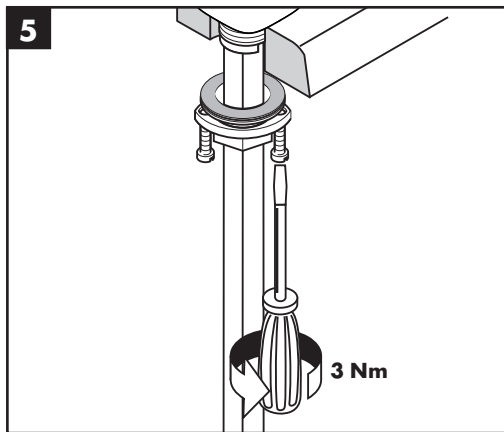

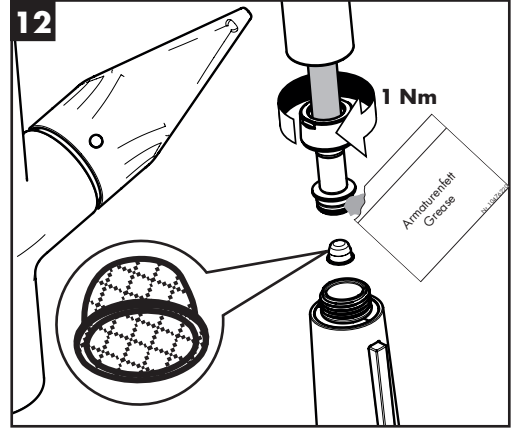
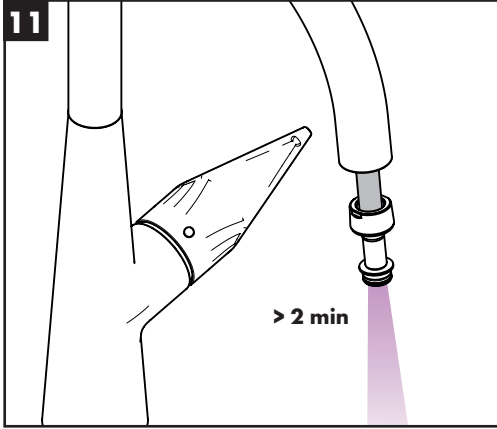



60 °C



10 °C



0,3 MPa  
0,3 MPa  
میجابسکال 0,3

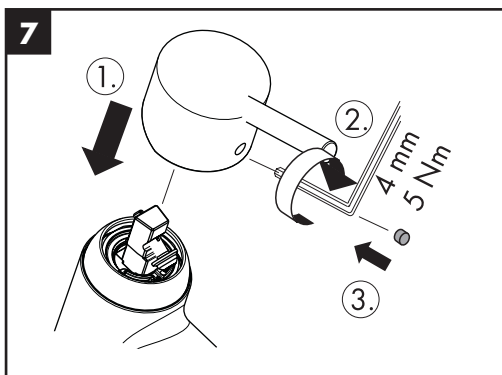
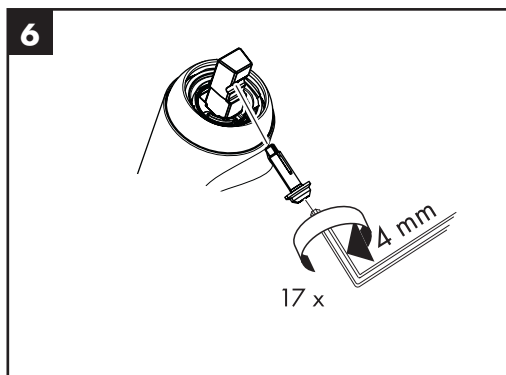
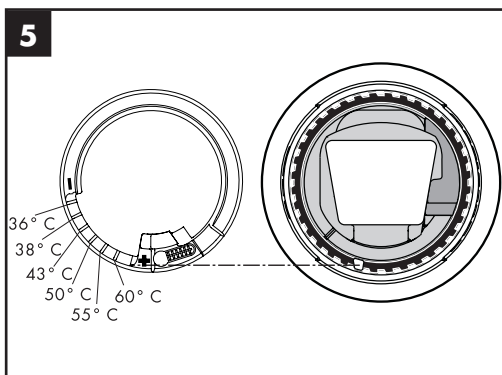
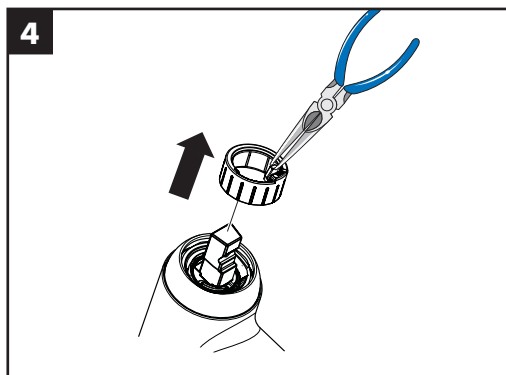
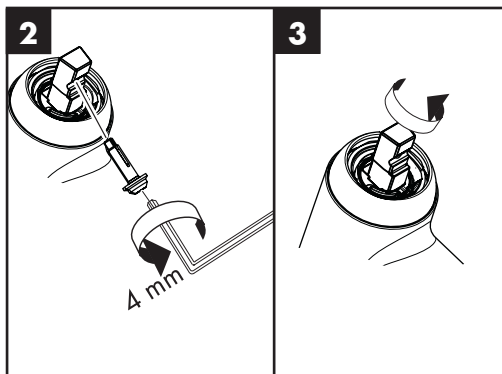
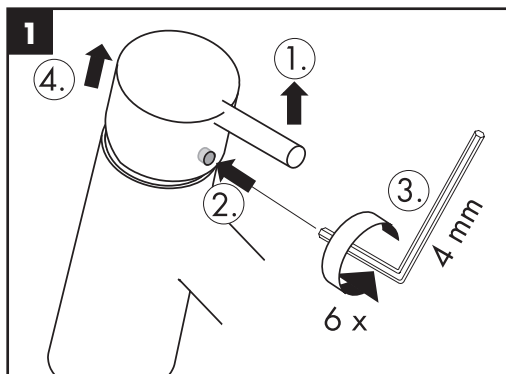

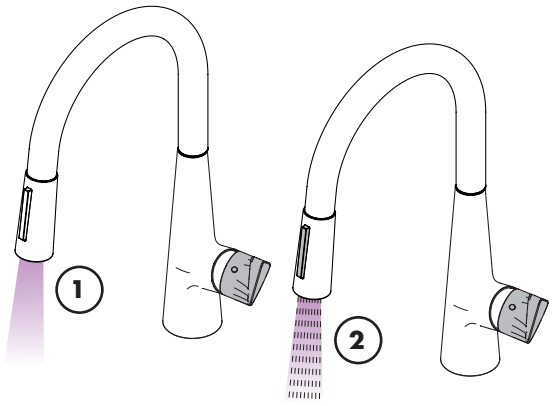
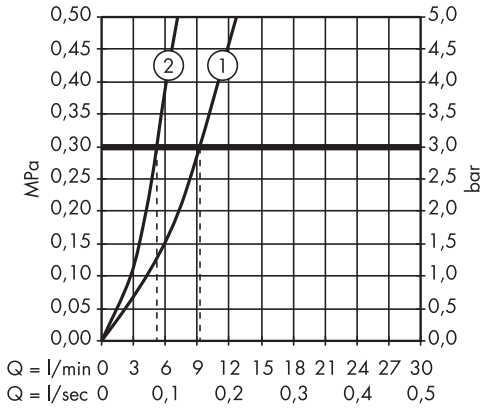
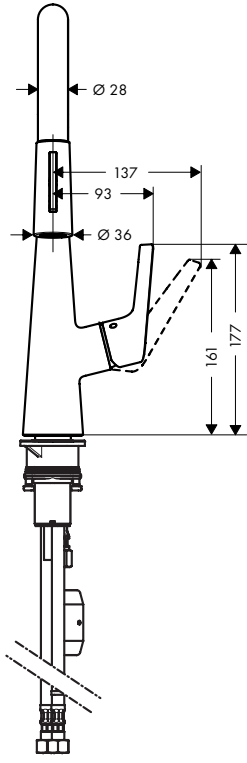
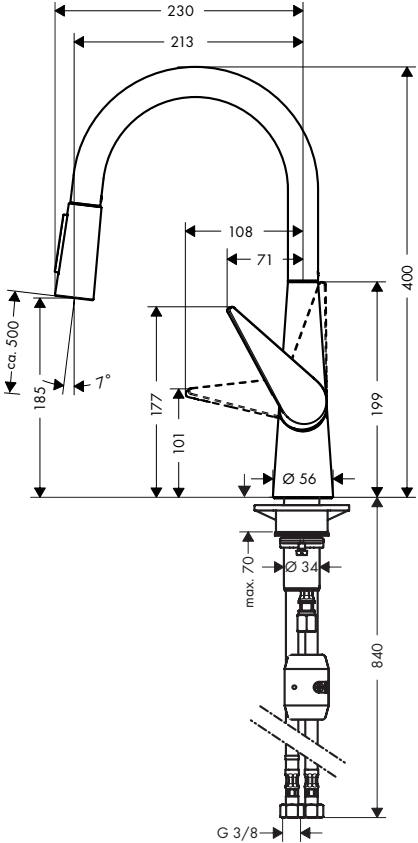

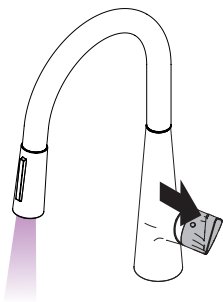

öffnen / ouvert / open / aperto / abierto / open / åbne /  
 abrir / otworzyć / otevřít / otvorit / 开 / открыть / nyitás /  
 avaaminen / öppna / atidaryti / Otvaranje / açmak /  
 deschide / ανοικτό / odpreti / avage / atvērt /  
 otvoriti / åpne / отварање / hape / فتح

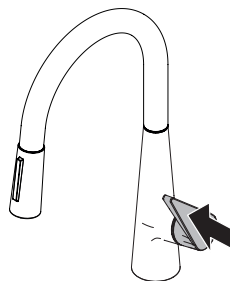

schließen / fermé / close / chiudere / cerrar / sluiten /  
 lukke / fechar / zamknąć / zavřít / uzavrieť / 关 /  
 закрыть / bezárás / sulkeminen / stänga / uždaryti /  
 Zatvaranje / kapatmak / închide / κλειστό /  
 zapreti / sulgege / aizvērt / zatvori / lukke / затваряње /  
 mbylle / إغلاق

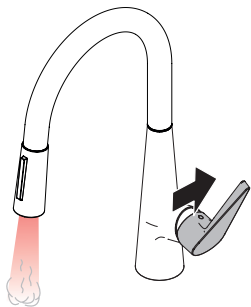

warm / chaud / hot / caldo / caliente / warm / varmt /  
 quente / ciepła / teplá / teplá / 热 / горячая / meleg /  
 lämmin / varmt / karštas / Vruća voda / sıcak / cald /  
 ζεστό / toplo / kuum / karsts / topla / varm / тепло /  
 i ngrohtë / ساخن

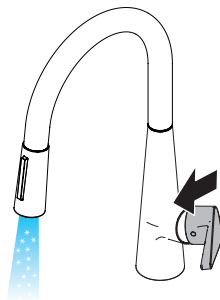

kalt / froid / cold / freddo / frío / koud / koldt / fria /  
 zimna / studená / studená / 冷 / холодная / hideg /  
 kylmä / kallt / šaltas / Hladno / soğuk / rece / κρύο /  
 mrzlo / külm / auksts / hladno / kaldt / студено / i fjohtë /  
 بارد

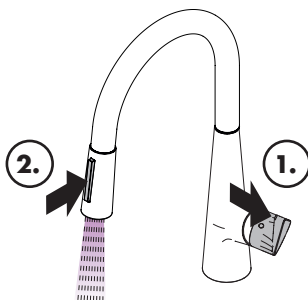

öffnen / ouvert / open / aperto / abierto / open / åbne /  
 abrir / otworzyć / otevřít / otvorit / 开 / открыть / nyitás /  
 avaaminen / öppna / atidaryti / Otvaranje / açmak /  
 deschide / ανοικτό / odpreti / avage / atvērt /  
 otvoriti / åpne / отварање / hape / فتح

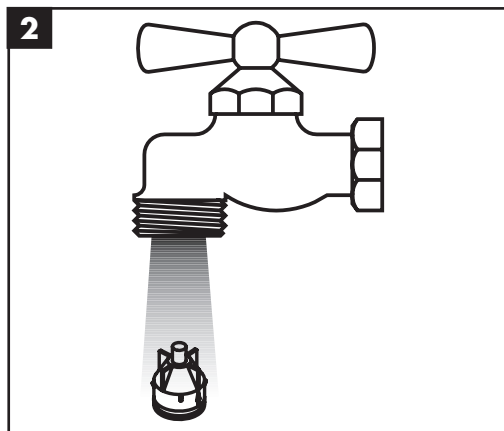
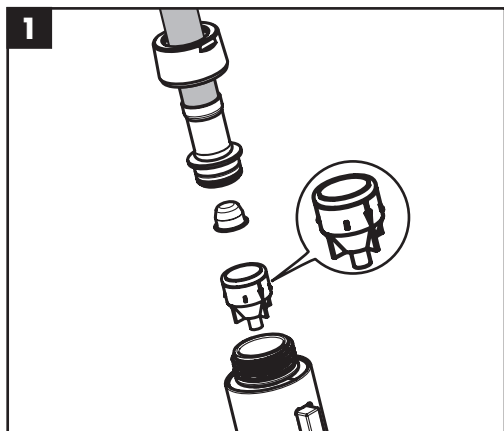
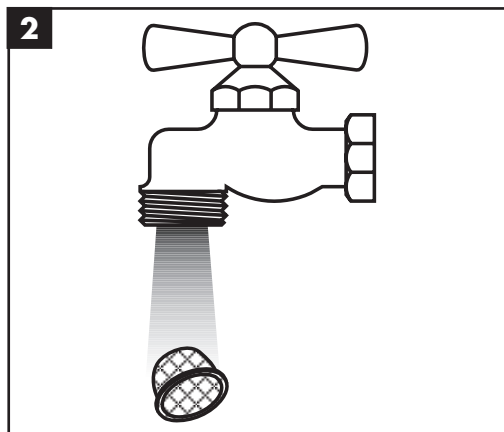
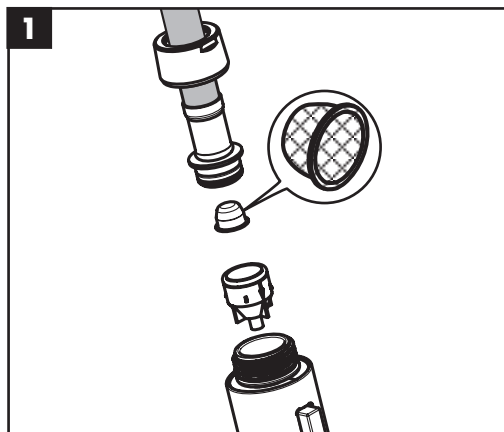

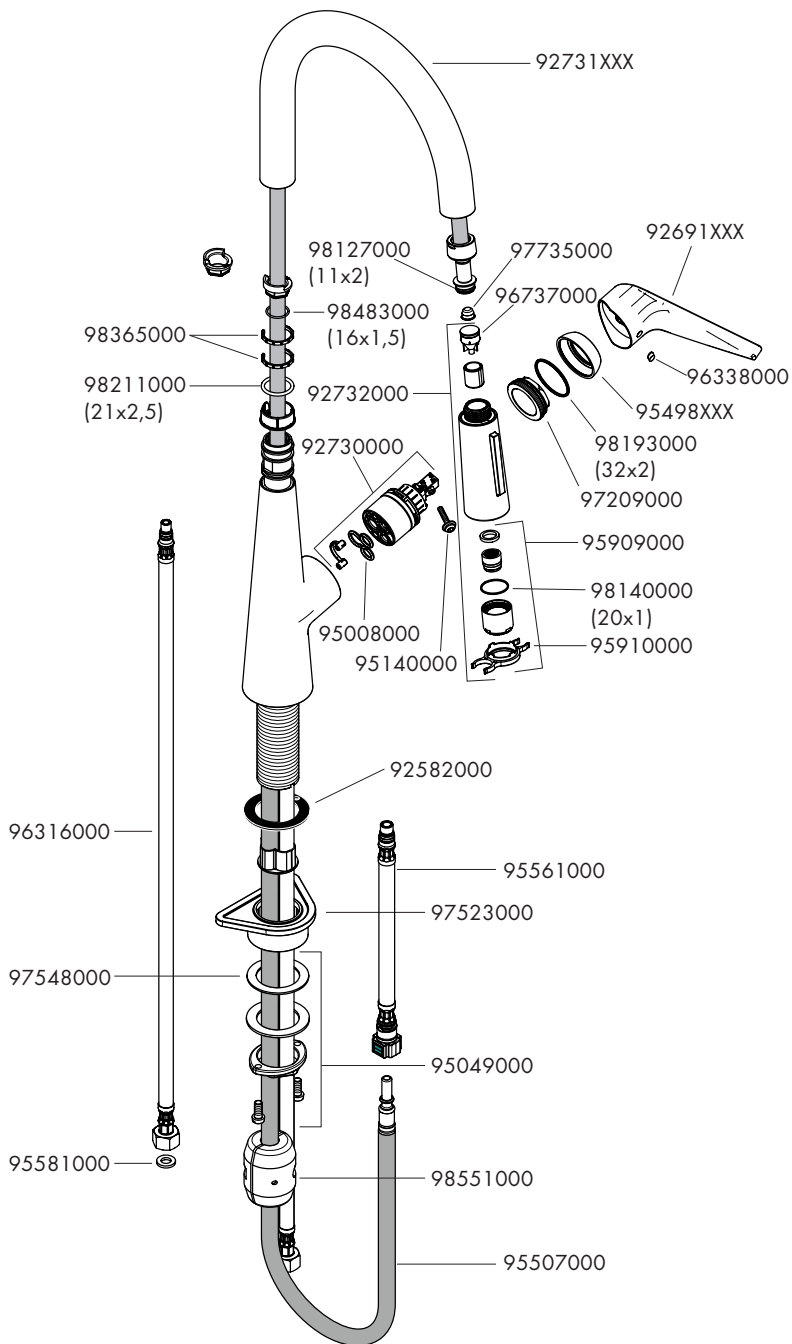

---

**hansgrohe**

Hansgrohe · Auestraße 5 · 9 · D-77761 Schiltach · Telefon +49 (0) 78 36/51-1282 · Telefax +49 (0) 7836/511440  
E-Mail: [info@hansgrohe.com](mailto:info@hansgrohe.com) · Internet: [www.hansgrohe.com](http://www.hansgrohe.com)

6/2015  
9.02756.01