

DuraStyle

DS 6482

Monteringsanvisning

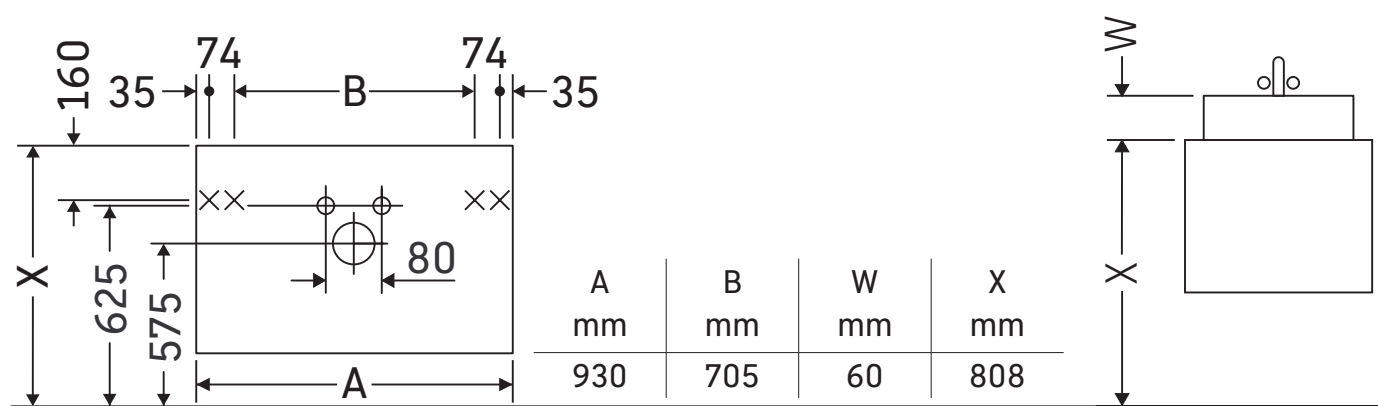

DuraStyle # 232010

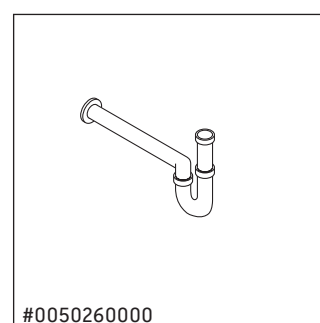
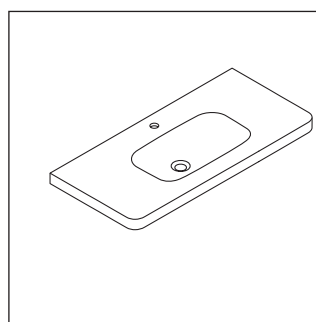
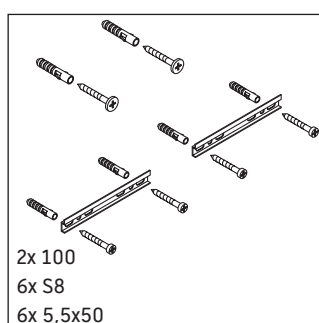
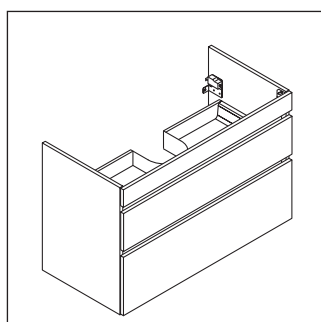

Användarinformation

Badrumsmöbelserien uppfyller gällande standarder och riktlinjer vid leveranstidpunkten och är konstruerad för användning i badrum. Undvik direkt fuktning med vatten exempelvis i samband med duschande.

Vi förbehåller oss rätten till tekniska förbättringar och optiska ändringar hos de avbildade produkterna.

