

+GF+

DE	Gebrauchsanleitung / Montageanleitung	2
EN	Instructions for use / assembly instructions	4
SV	Bruksanvisning / Monteringsanvisning	6
DK	Brugsanvisning / Monteringsvejledning	8
NO	Bruksanvisning / Montasjeveiledning	10
FI	Käyttöohje / Asennusohje	12

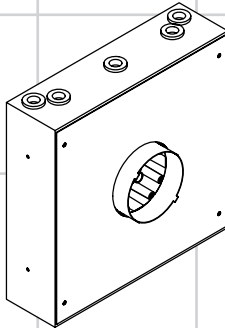

RSK: 8310344
HG#01820180



RSK: 8236120
GF#200 119 150

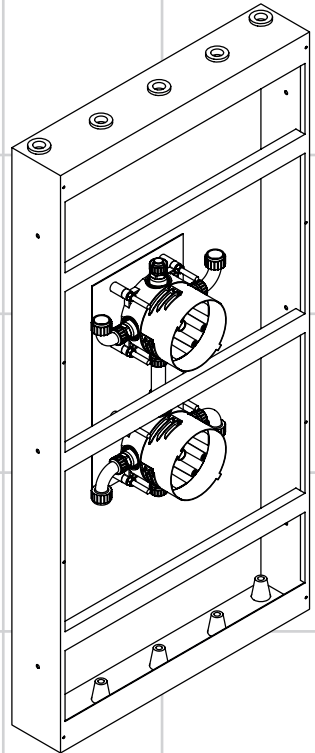

RSK: 8236121
GF#200 119 151





Montagehinweise

Die iBox ist sowohl für Wannen- als auch für Brauseninstallation geeignet. Bei Einhand Wannenmischer / Thermostat mit Absperr- und Umstellventil ist der untere Abgang vorrangig. Bei Brauseinstallation muss der nicht benötigte Abgang mit einem Stopfen abgedichtet werden.

Große Druckunterschiede zwischen den Kalt- und Warmwasseranschlüssen müssen ausgeglichen werden.

Grundkörper so einbauen, daß sich der Warmwasseranschluß links und der Kaltwasseranschluß rechts befindet.

Verlängerung 25 mm Artikelnummer 13595000

Die Montageanleitung beschreibt die Leitungsinstallation konform mit den Vorgaben von "Säker Vatteninstallation" (Sichere Wasserinstallation). Georg Fischer AB garantiert die Funktion der Produkte und des Systems wenn die Landesvorschriften und diese Montageanleitung befolgt wurden.

Siehe die beigegefügte Montageanleitung für Sanipex Classic.

Installationsbeispiele mit Maßangaben und Leitungsdimensionierung sind ab Seite 14 zu finden.

Die in der Montageanleitung angegebenen Montagemaße sind ideal für Personen von ca. 1800 mm Körpergröße und müssen gegebenenfalls angepasst werden. Hierbei ist darauf zu achten, dass sich bei geänderter Montagehöhe die Mindesthöhe ändert und die Änderung der Anschlussmaße berücksichtigt werden müssen.

Spülen

Komplette Installation gemäß DIN 1988 / EN 1717 spülen. Die Pfeile auf dem Spülblock zeigen, welcher Zulauf mit welcher Abgangsleitung verbunden ist, z. B. Kaltwasser mit Abgang 1 und Warmwasser mit Abgang 2. Falls nur ein Abgang benötigt wird, muß nach dem ersten Spülvorgang der Spülblock um 90° gedreht werden.

Technische Daten

Betriebsdruck:	max. 1 MPa
Empfohlener Betriebsdruck:	0,1 - 0,5 MPa
Prüfdruck:	1,6 MPa
(1 MPa = 10 bar = 147 PSI)	
Heißwassertemperatur:	max. 80 °C
Empfohlene Heißwassertemperatur:	65 °C
Anschlussmaße:	G 3/4
Anschlüsse:	kalt rechts - warm links
Freier Durchfluss bei 0,3 MPa:	
Brausemischer:	32 l/min
Thermostat:	43 l/min
Thermostat mit Absperrventil:	26 l/min
Thermostat mit Absperr- und Umstellventil:	26 l/min
Thermostat High Flow:	58 l/min
Wannenmischer:	31 l/min // 24 l/min

Symbolbeschreibung



Warmwasser



Kaltwasser



Ab • ist die Funktion gewährleistet.



Nur ein Verbraucher möglich, nicht zwei gleichzeitig.



Der nicht benötigte Abgang muss mit Stopfen und Überwurfmutter abgedichtet werden. (16 mm / 20 mm)





Wannenmischer
(siehe Seite 14)

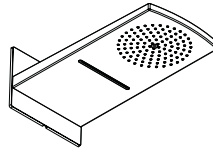

Raindance Rainfall 180
(siehe Seite 28)

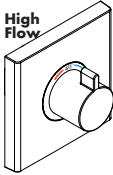

High Flow
Thermostat
(siehe Seite 28)

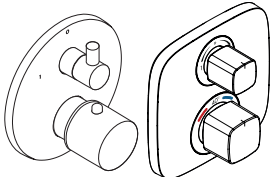

Thermostat mit Absperr-
und Umstellventil
(siehe Seite 16, 22, 24)

Es gibt noch zahlreiche andere Fertigsets und
Kopfbrausen, die auf die iBox universal montiert werden
können. Diese sind in der aktuellen Preisliste zu finden.

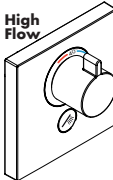

High Flow
Thermostat mit
Absperrventil
(siehe Seite 30, 32)

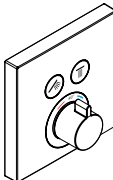

Thermostat mit
Absperrventil
(siehe Seite 18, 26)

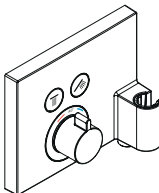

Thermostat mit
Absperrventil
(siehe Seite 20)

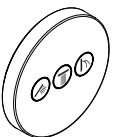
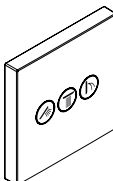

ShowerSelect
3 x Absperrventil (siehe
Seite 28, 30, 32)





Installation Instructions

The iBox is suitable for both bath and shower applications. When using the bath-shower mixer / thermostatic mixer with shut off and diverter unit outlet, the lower outlet must have priority. For shower applications, plug the unused outlet with a plug.

The hot and cold supplies must be of equal pressures.

Install body with the hot water supply left and cold water supply right.

extension 25 mm article number 13595000

The installation instructions are primarily concerned with tap water and Installation. Georg Fischer guarantees the products and the system if the installation instructions are followed.

See the attached Installation instructions for Sanipex Classic.

Installation examples with measurements and pipe dimensions can be found starting on page 14.

The installation dimensions stated in these installation instructions are ideal for people of approximately 1800 mm in body height. The dimensions can be altered if required. In this case, pay attention to the fact that a change of installation height will also change the minimum height, and that the altered mounting dimensions must be taken into consideration.

Flush piping system

To complete the installation flush out both hot and cold water supply. The arrows on the flush body are showing, which inlet is connected with which outlet, for example cold water supply with outlet 1 and hot water supply with outlet 2. If only one outlet is in use, after first flushing the flush body must be turned about 90°.

Technical Data

Operating pressure:	max. 1 MPa
Recommended operating pressure:	0,1 - 0,5 MPa
Test pressure:	1,6 MPa
(1 MPa = 10 bar = 147 PSI)	
Hot water temperature:	max. 80 °C
Recommended hot water temp.:	65 °C
Centre distance:	G 3/4
Connections:	cold right - hot left
Rate of flow by 0,3 MPa:	
Shower mixer:	32 l/min
Thermostatic mixer:	43 l/min
Thermostatic mixer with shut off unit:	26 l/min
Thermostatic mixer with shut off and diverter unit:	26 l/min
Thermostatic mixer High Flow:	58 l/min
Bath-shower mixer:	31 l/min // 24 l/min



Symbol description



Warm water



Cold water



From • the function is guaranteed.



Only one function is possible.



Plug the unused outlet with plug and nut (16 mm / 20 mm)



Bath-shower mixer
(see page 14)

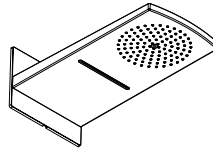

Raindance Rainfall 180
(see page 28)

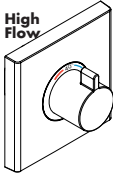

High Flow
High Flow Thermostatic mixer
(see page 28)

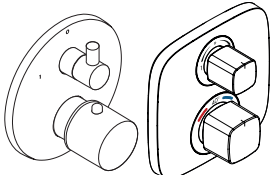

Thermostatic mixer with
shut off and diverter unit
(see page 16, 22, 24)

There are a lot of other finished sets and overhead showers that can be mounted on the iBox universal. These can be found in the current price book.

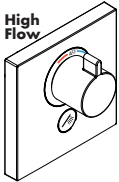

High Flow
High Flow Thermostatic mixer with shut off unit
(see page 30, 32)

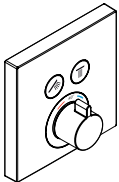

Thermostatic mixer with
shut off unit
(see page 18, 26)

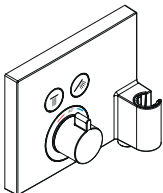

Thermostatic mixer with
shut off unit
(see page 20)

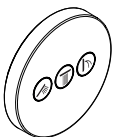
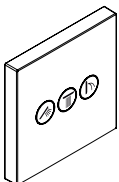

ShowerSelect
3 x stop valve (see page
28, 30, 32)



Assembly see page 34



Monteringsanvisningar

IBox är avsedd för såväl kar- som duschinstallation. Till enhandsblandare / termostat med spärr- och omställningsventil används främst det undre avloppet. Vid installation i dusch måste man sätta en propp i det avlopp som inte behövs så att detta är tätt.

Stora tryckskillnader mellan anslutningarna för varmt och kallt vatten måste utjämnas.

Montera grundkonstruktionen så att varmvattensanslutningen sitter till vänster och kallvattenanslutningen till höger.

Förlängning 25 mm artikelnummer 13595000

Monteringsanvisningen avser i första hand tappvattensystem och överensstämmer med "Branschregler för Säker Vatteninstallation." Georg Fischer AB garanterar produkterna och systemets funktion om branschreglerna och denna installationsanvisning följs.

Se bifogad Installationsanvisning för Sanipex Classic.

Du hittar installationsexempel med uppgifter om mått och ledningsdimensioner från sidan 14.

De monteringsmått som anges i monteringsanvisningen passar 1,80 m långa personer och måste eventuellt anpassas. Det är då viktigt att tänka på att den minsta höjden ändras när monteringshöjden blir en annan och att hänsyn måste tas till de ändrade anslutningsmåten.

Spola

Spola igenom hela installationen enligt DIN 1988 / EN 1717. Pilarna på spolblocket visar vilken inkommande ledning som är ansluten till vilket avlopp, t.ex. kallvatten till avlopp 1 och varmvatten till avlopp 2. Om det bar behövs ett avlopp måste spolblocket vridas 90° efter första spolningen.

Tekniska data

Driftstryck:	max. 1 MPa
Rek. driftstryck:	0,1 - 0,5 MPa
Tryck vid provtryckning:	1,6 MPa
(1 MPa = 10 bar = 147 PSI)	
Varmvattentemperatur:	max. 80 °C
Rek. varmvattentemp.:	65 °C
Anslutningsmått:	G 3/4
Anslutningar:	kallt höger - varmt vänster
Fri genomströmning vid 0,3 MPa:	
Duschblandare:	32 l/min
Termostat:	43 l/min
Termostat med spärrventil:	26 l/min
Termostat med spärr- och omställningsventil:	26 l/min
Termostat High Flow:	58 l/min
Karblandare:	31 l/min // 24 l/min

Symbolbeskrivning



Varmvatten



Kallvatten



Från • garanteras funktionen.



Endast en enhet möjlig, inte två samtidigt.



Det utlopp som inte behövs måste tätas med en propp som sättes i kopplingsmuttern. (16 mm / 20 mm)





Karblandare
(se sidan 14)

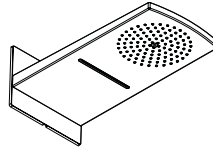

Raindance Rainfall 180
(se sidan 28)

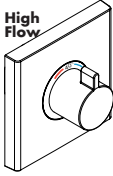

High Flow
Termostat
(se sidan 28)

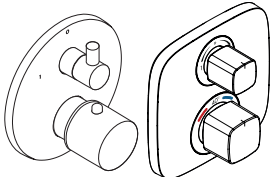

Termostat med spärr- och
omställningsventil
(se sidan 16, 22, 24)

Det finns många fler lösningar med 1-grepp och termostatblandare samt takduschar som kan monteras tillsammans med iBox Nordic universal. Dessa hittar man i aktuell prisbok / katalog.

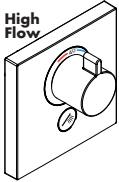

High Flow
Termostat med
spärrventil
(se sidan 30, 32)

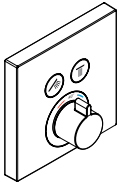

Termostat med
spärrventil
(se sidan 18, 26)

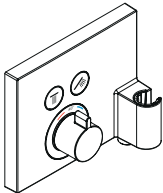

Termostat med
spärrventil
(se sidan 20)

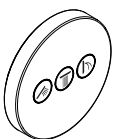
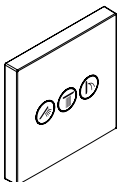

ShowerSelect
3 x Spärrventil (se sidan
28, 30, 32)





Monteringsanvisninger

Ilboxen er egnet til såvel kar- som til bruseinstallation. Ved 1-grebs kararmatur / termostat med afspæringsventil og omskifter er afgang forneden primæragang. Ved bruseinstallation skal den overflødige afgang afproppes.

Større trykforskelle mellem koldt og varmt vand bør udjævnes.

Grundkroppen indbygges således, at varmtvandstilslutningen er til venstre og koldt vandstilslutningen er til højre.

Forlængersæt 25 mm art. nr. 13595000

Installationsvejledningen beskriver monteringen i overensstemmelse med "industripolitik for Safe Water installation." Georg Fischer AB garanterer produkterne og deres funktion såfremt installationen er udført i henhold til monteringsvejledningen.

Se vedlagte Installationsvejledning til Sanipex Classic.

Installationseksempler med mål og ledningsdimensioner kan efterlæses fra side 14.

Målene i monteringsanvisningen er ideal til personer med en størrelse på 1800 mm og skal i givet fald tilpasses. Herved skal der tages hensyn til, at den mindste højde i tilfælde af en ændret monteringshøjde ændres og at der skal tages hensyn til de ændrede tilslutningsmål.

Gennemskylning

Den komplette installation skal gennemskyllses efter DIN 1988 / EN 1717. Pilene på tegningen viser, hvilke tilgange og afgange der er forbundet med hinanden, f.eks. koldt vand med afgang 1 og varmt vand med afgang 2. I tilfælde hvor kun én afgang benyttes, skal skylleblokken drejes 90° efter første gennemskylning.

Tekniske data

Driftstryk:	max. 1 MPa
Anbefalet driftstryk:	0,1 - 0,5 MPa
Prøvetryk:	1,6 MPa
(1 MPa = 10 bar = 147 PSI)	
Varmtvandstemperatur:	max. 80 °C
Anbefalet varmtvandstemperatur:	65 °C
Tilslutningsmål:	G 3/4
Tilslutninger:	Koldt højre - varmt venstre
Fri gennemstrømning ved 0,3 MPa:	
Brusearmaturer:	32 l/min
Termostat:	43 l/min
Termostat med afspæringsventil:	26 l/min
Termostat med afspæringsventil og omskifter:	26 l/min
Termostat High Flow:	58 l/min
Kararmaturer:	31 l/min // 24 l/min



Symbolbeskrivelse



Varmt vand



Kold vand



Fra • er funktionen anvendelig.



Det er kun muligt at benytte én funktion ad gangen.



Afgangen, der ikke benyttes, skal afproppes med prop, der er tilføjet i koblingsmøtrikken. (16 mm / 20 mm)



Kararmaturer
(se s. 14)

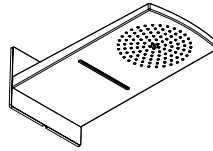

Raindance Rainfall 180
(se s. 28)

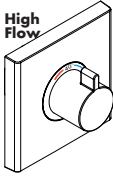

High Flow Termostat
(se s. 28)

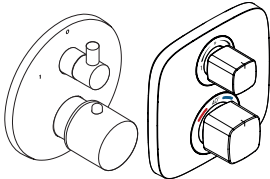

Termostat med afspæringsventil og omskifter
(se s. 16, 22, 24)

Der er mange andre kappesæt og hovedbrugere, der kan monteres på iBox universal. Disse kan findes i den nuværende prislister.

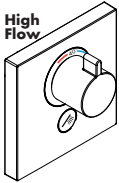

High Flow Termostat med afspæringsventil
(se s. 30, 32)

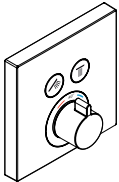

Termostat med afspæringsventil
(se s. 18, 26)

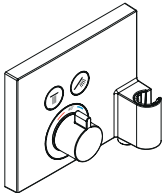

Termostat med afspæringsventil
(se s. 20)

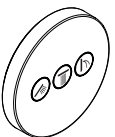
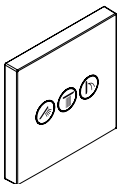

ShowerSelect
3 x Afspæringsventil (se s. 28, 30, 32)





Montagehenvisninger

iBoxen egner seg både for installasjon på dusj eller badekar. Ved enhånd-blandebatteri for badekar / termostat med sperre- og omstillingsventil prioriteres nedre utgangen. Ved installasjon i dusjen skal utgangen som ikke brukes tettes med en plugg.

Store trykkdifferanser mellom kaldt- og varmtvannstilkoblinger skal utlignes.

Basiselementet bygges inn slik at varmtvannstilkobling er på venstre og kaldtvannstilkobling er på høyre side.

Forlengelse 25 mm Artikelnummer 13595000

Monteringsanvisningen er primært for tappevannsinstallasjon og i samsvar med "Bransjekrav for sikker vanninstallasjon (Sverige)." Georg Fischer AB garanterer produktene om bransjeregler og denne monteringsanvisningen blir fulgt.

Se vedlagte monteringsanvisningen for Sanipex Classic.

Installasjonseksempel med målangivelser og ledningsdimensjoner finns fom. side 14.

Monteringsmål i monteringsveiledningen er beregnet for personer som er omtrent 1800 mm høye, målene skal eventuell tilpasses om nødvendig. Her skal man passe på at ved endrede monteringsmålene blir minstehøyden endret, og det må tas hensyn til de endrede tilkoblingsmålene.

Spyle

Komplett installasjon spyles iht. DIN 1988 / EN 1717. Pilene på spyleblokken indikerer hvilke tilløp som er koblet sammen med hvilken utgangsledning, f.eks. kaldtvann med utgang 1 og varmtvann med utgang 2. Hvis det kun er nødvendig med en utgang, skal spyleblokken dreies med 90° etter den første spylingen.

Tekniske data

Driftstrykk	maks. 1 MPa
Anbefalt driftstrykk:	0,1 - 0,5 MPa
Prøvetrykk	1,6 MPa
(1 MPa = 10 bar = 147 PSI)	
Varmtvannstemperatur	maks. 80 °C
Anbefalt temperatur for varmt vann	65 °C
Tilkoblingsmål:	G 3/4
Tilkoblinger:	kaldt høyre - varm venstre
Fri gjennomstrømning ved 0,3 MPa:	
Dusj-blandebatteri:	32 l/min
Termostat:	43 l/min
Termostat med sperreventil:	26 l/min
Termostat med sperre- og omstillingsventil:	26 l/min
Termostat High Flow:	58 l/min
Blandebatteri for badekar:	31 l/min // 24 l/min

10



Montasje se side 34

Symbolbeskrivelse



Varmtvann



Kaldtvann



F.o.m. • er funksjonen garantert



Kun en forbruker mulig, ikke to samtidig.



Utgangen som ikke brukes tettes med en propp som settes i koplingsmutteren. (16 mm / 20 mm) og utgang på lbox som ikke brukes plugges



Blandebatteri for badekar
(se side 14)

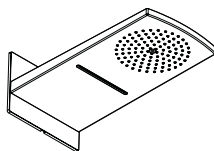

Raindance Rainfall 180
(se side 28)

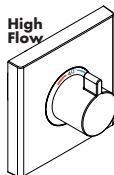

High Flow Termostat
(se side 28)

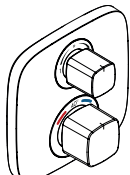
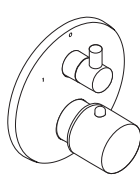

Termostat med sperre- og omstillingsventil
(se side 16, 22, 24)

Det er også andre ferdigesett og hodedusjer som kan monteres på iBox universal. Disse finner du i HG prislister.

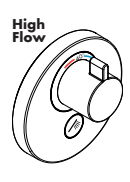
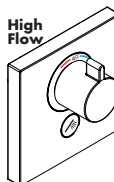

High Flow Termostat med sperreventil
(se side 30, 32)

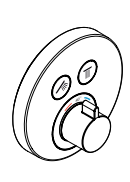
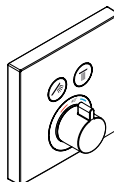

Termostat med sperreventil
(se side 18, 26)

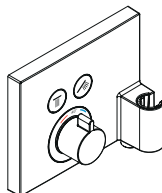

Termostat med sperreventil
(se side 20)

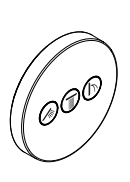
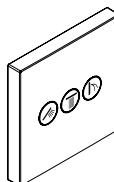

ShowerSelect
3 x Sperreventil (se side 28, 30, 32)





Asennusohjeet

iBox soveltuu sekä amme- että myös suihkuasennukseen. Kun käytetään yksioite amme- ja suihkuhanaa / termostaattia yhdistetyllä käyttöventtiili/vaihtimella, alempi ulosotto on ensisijainen. Suihkuasennuksessa käyttämättä jäänyt lähtö pitää tulpata.

Suuret paine-erot kylmä- ja kuumavesiliitäntöjen välillä on tasattava.

Asenna runko-osa siten, että lämminvesiliitäntä tulee vasemmalle ja kylmävesiliitäntä aina oikealle puolelle.

Jatko-osa 25 mm tuotenumero 13595000

Asennusohjeet ovat ensisijaisesti vesijohtovedelle ja noudattavat "Branschregler för Säker Vatteninstallation"-ohjeistusta. Georg Fischer AB takaa tuotteiden ja järjestelmän toimivuuden, jos näitä asennusohjeita noudatetaan.

Katso liitteenä olevat asennusohjeet Sanipex Classic.

Asennusesimerkit mittoineen ja putkitietoineen löytyvät alkaen sivulta 14.

Asennusohjeessa annetut asennusmitat sopivat n. 180 cm:n pituiselle henkilölle, ja niitä on tarvittaessa muutettava. Tässä on otettava huomioon, että asennuskorkeuden muuttuessa muuttuu myös vähimmäiskorkeus, ja muutos on otettava huomioon liitäntöjen mitoissa.

Huuhtelu

Koko asennettu järjestelmä on huuhdeltava DIN 1988/ EN 1717 mukaisesti. Huuhtelulohkossa olevat nuolet osoittavat mikä tulo on liitettyä mihinkin lähtöön, esim. kylmävesi lähtöön 1 ja lämminvesi lähtöön 2. Jos tarvitaan vain 1 lähtö, ensimmäisen huuhtelun jälkeen huuhtelulohkoa on kierrettävä 90°.

Tekniset tiedot

Käyttöpain:	maks. 1 MPa
Suositteltu käyttöpain:	0,1 - 0,5 MPa
Koestuspaine:	1,6 MPa
(1 MPa = 10 bar = 147 PSI)	
Kuuman veden lämpötila:	maks. 80 °C
Kuuman veden suosituslämpötila:	65 °C
Liitäntämitat:	G 3/4
Liittimet:	kylmä oikealla - kuuma vasemmalla
Vapaa läpivirtaus 0,3 MPa paineella:	
Suihkusekoittaja:	32 l/min
Termostaatti:	43 l/min
Termostaatti sulkuventtiilillä:	26 l/min
Termostaatti sulku- ja vaihtventtiilillä:	26 l/min
Termostaatti High Flow:	58 l/min
Ammesekoittaja:	31 l/min // 24 l/min

Merkin kuvaus



Lämmin vesi



Kylmä vesi



Tämä toiminta on taattuna • alkaen.



Vain yksi vedenkäyttöpiste kerrallaan on mahdollista, ei kahta samanaikaisesti.



Lähtöä jota ei käytetä, tulpataan tulpalla, joka asennetaan muunnosliitimeen (16 mm / 20 mm).





Ammesekoittaja
(katso sivu 14)

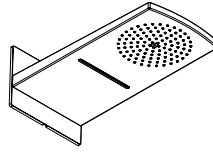

Raindance Rainfall 180
(katso sivu 28)

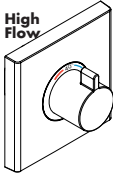

High Flow Termostaatti
(katso sivu 28)

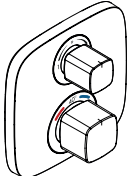
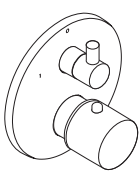

Termostaatti sulku- ja
vaihtoverteillä
(katso sivu 16, 22, 24)

Valikoimassa on paljon muita pintaosia ja yläsuihkuja, jotka voidaan asentaa iBox universal-runko-osan kanssa. Nämä löytyvät voimassaolevasta hinnastosta.

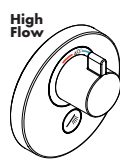
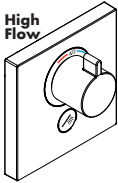

High Flow Termostaatti
sulkuventtiilillä
(katso sivu 30, 32)

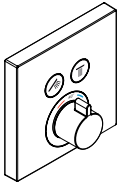

Termostaatti
sulkuventtiilillä
(katso sivu 18, 26)

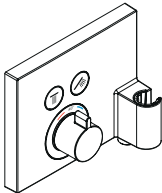

Termostaatti
sulkuventtiilillä
(katso sivu 20)

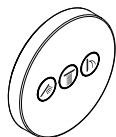
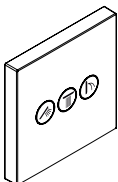

ShowerSelect
3 x Sulkuventtiili (katso
sivu 28, 30, 32)



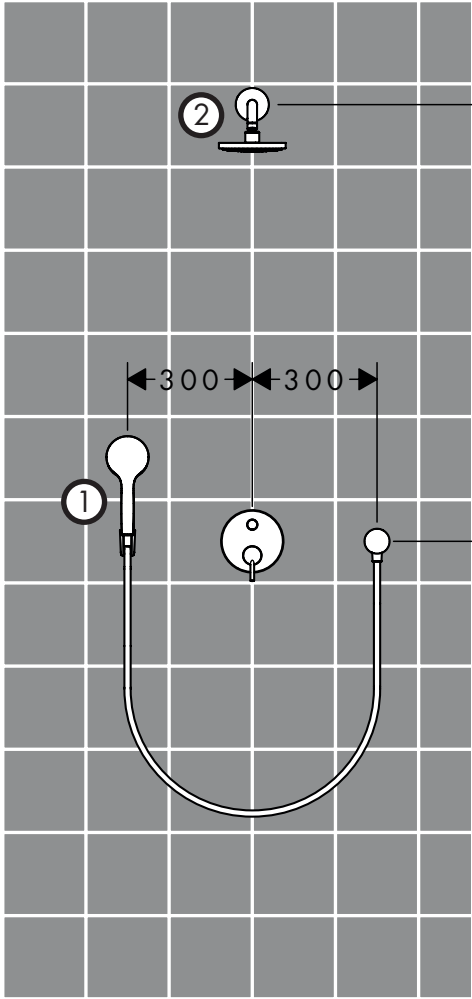
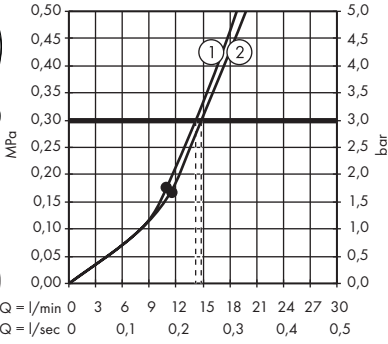

Talis S

32475000
RSK 8227149

Croma 100

27450000
RSK 8376736

Showerarm 230 mm

27412000
RSK 8376731

Fixfit

27454000
RSK 8184316

Croma 100 Vario + Porter S + Isiflex

1,60 m
27594000
RSK 8376743

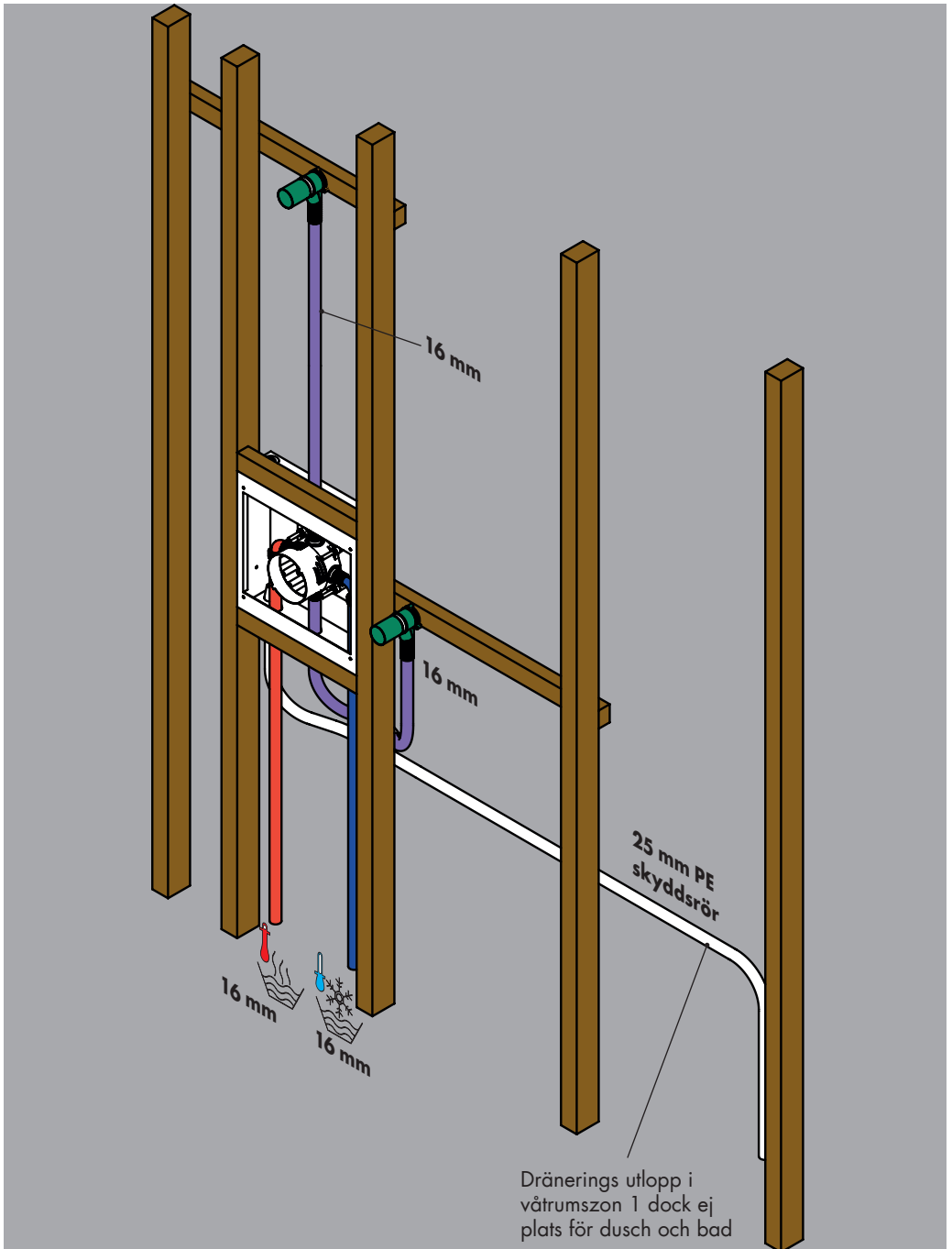

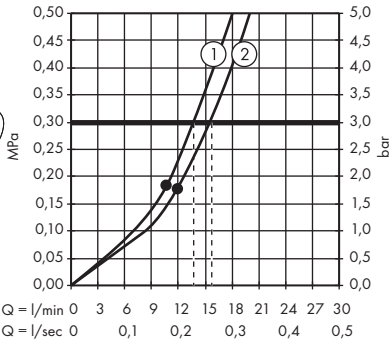
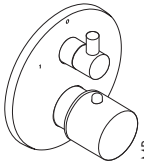

Q = l/min 0 3 6 9 12 15 18 21 24 27 30
 Q = l/sec 0 0,1 0,2 0,3 0,4 0,5

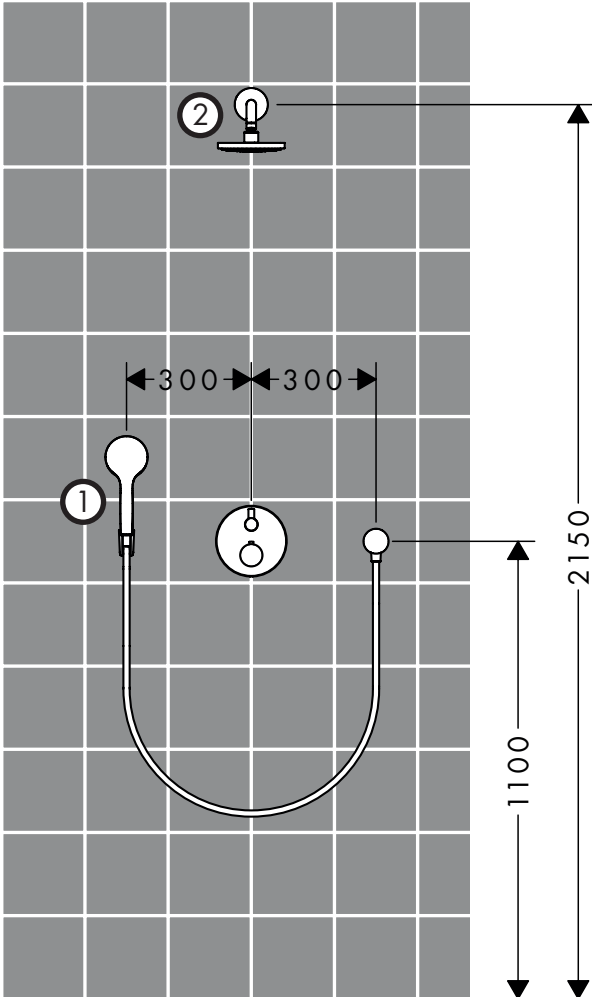

Ecostat S

15721000
 RSK 8310069

Croma 100

27450000
 RSK 8376736

Showerarm 230 mm

27412000
 RSK 8376731

Fixfit

27454000
 RSK 8184316

Croma 100 Vario + Porter S + Isiflex

1,60 m
 # 27594000
 RSK 8376743

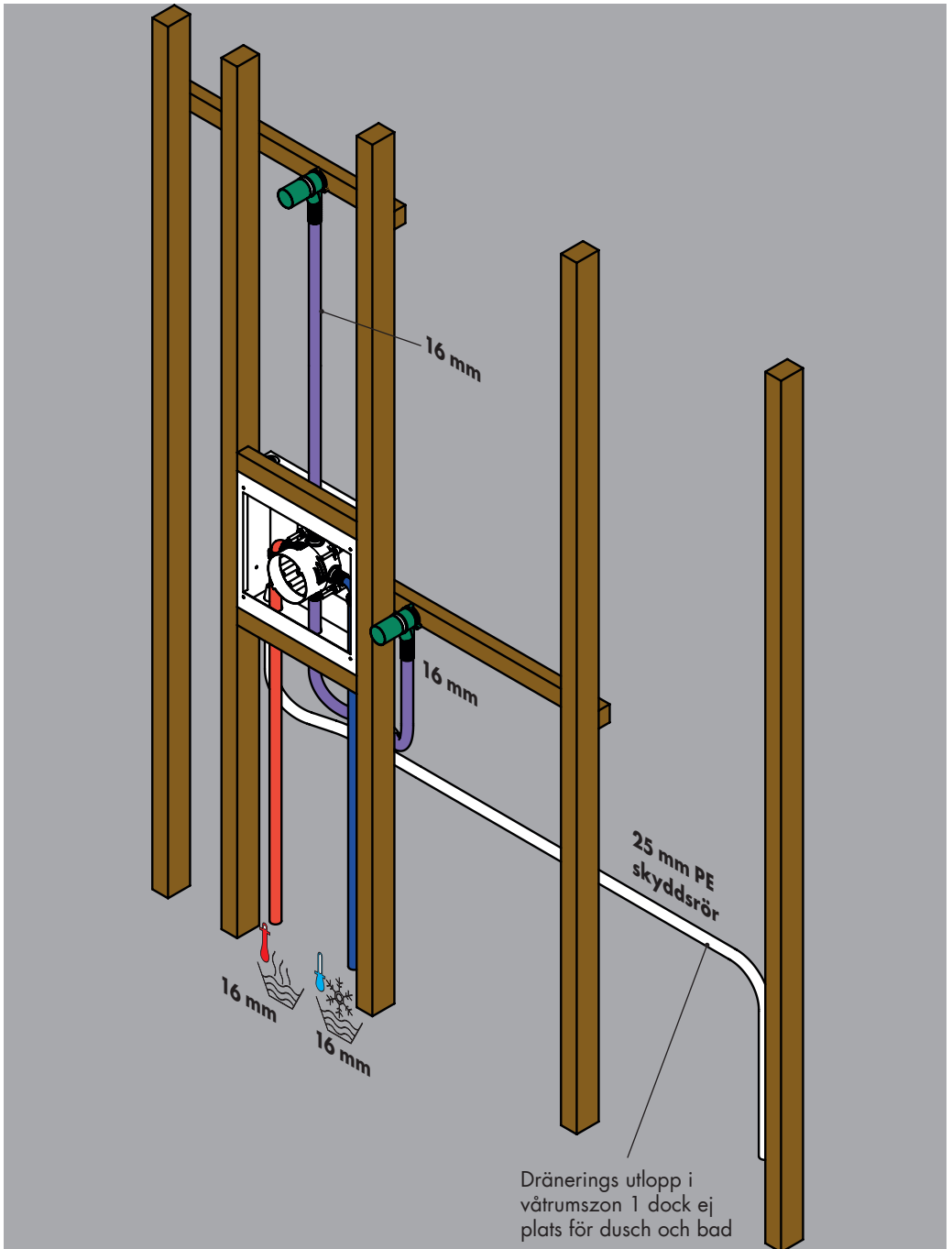

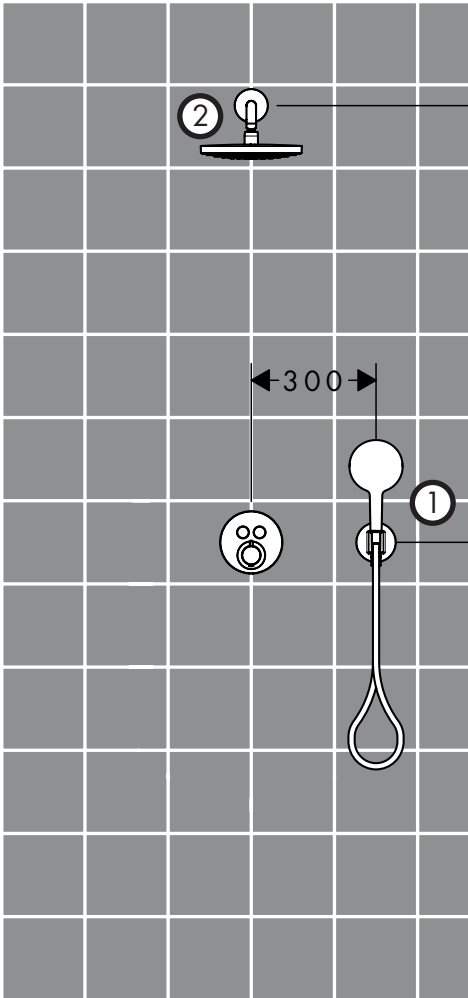
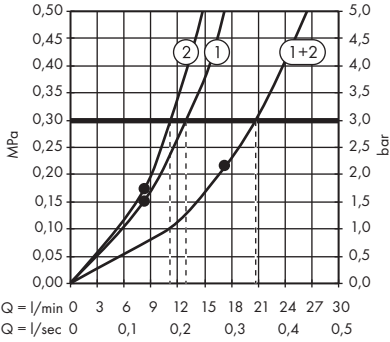
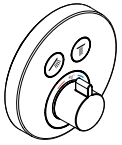

ShowerSelect S

15743000
RSK 8310290

Raindance Select S 240 2jet

26466000
RSK 8376901

Raindance Select S 120 3jet

26530000
RSK 8376814

Isiflex 1,60 m

28276000
RSK 8377181

Fixfit Porter S

26487000
RSK 8310371

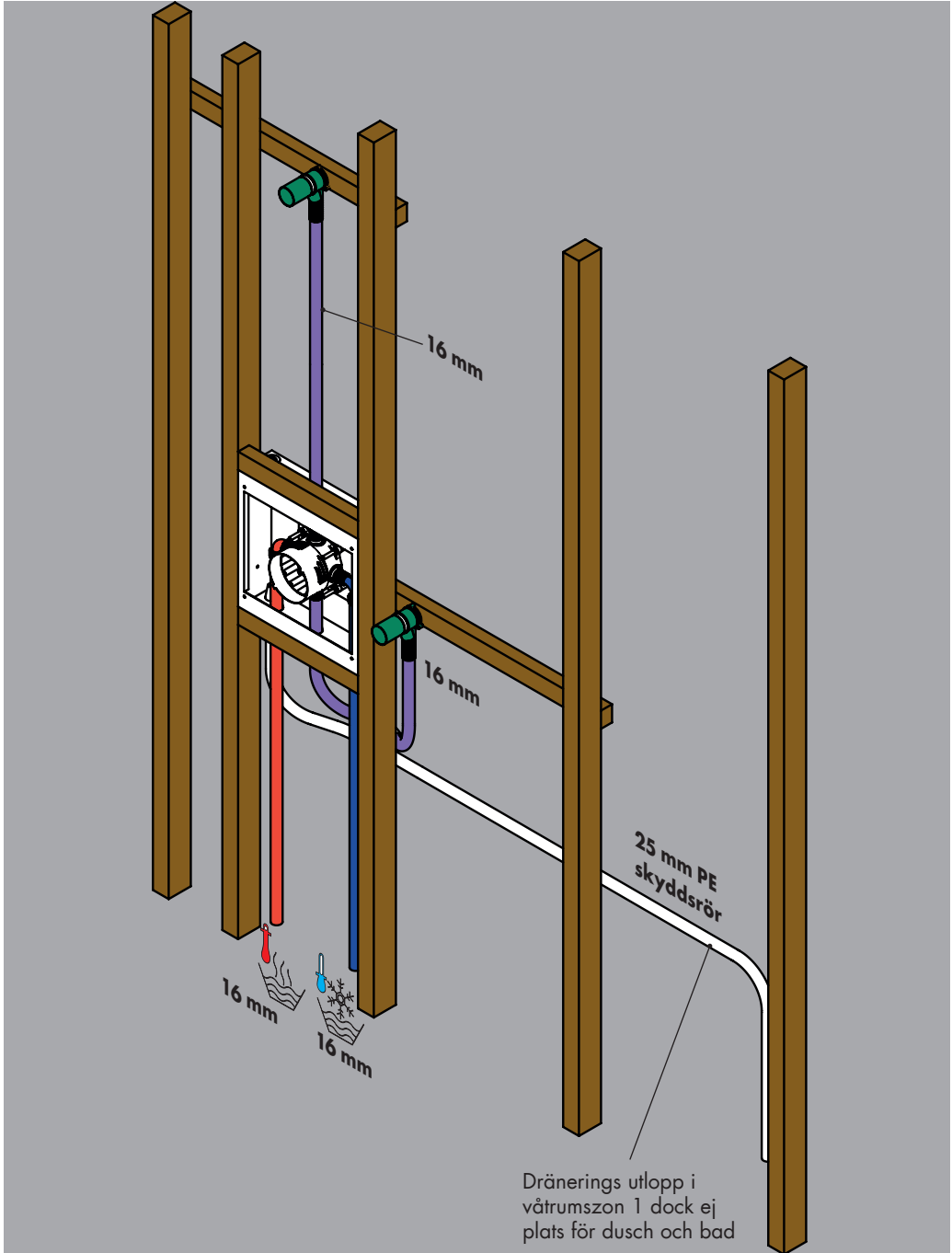

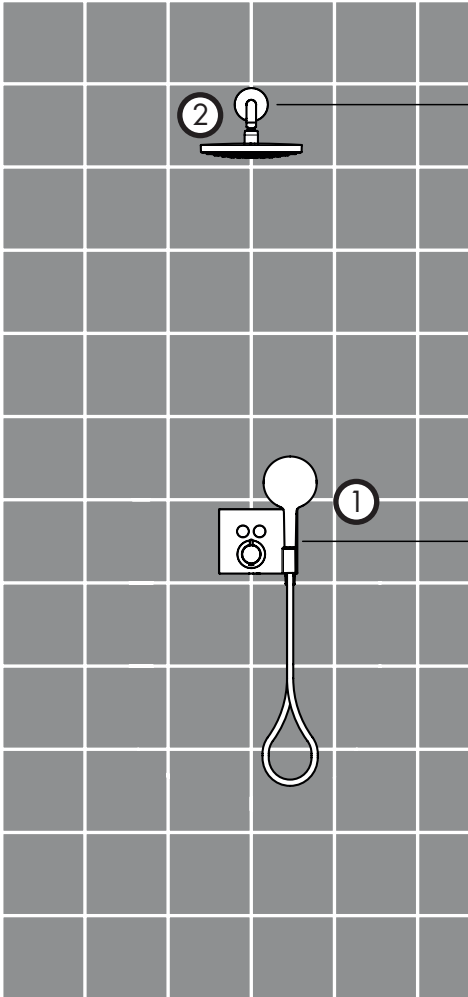
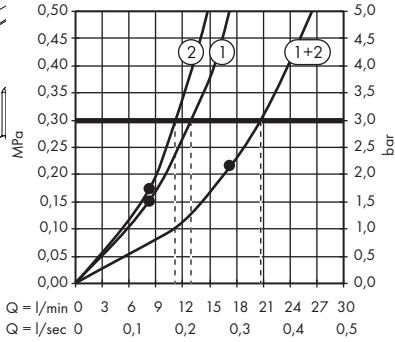
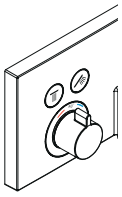

ShowerSelect

15765000
RSK 8310281

Raindance Select S 240 2jet

26466000
RSK 8376901

Raindance Select S 120 3jet

26530000
RSK 8376814

Isiflex 1,60 m

28276000
RSK 8377181

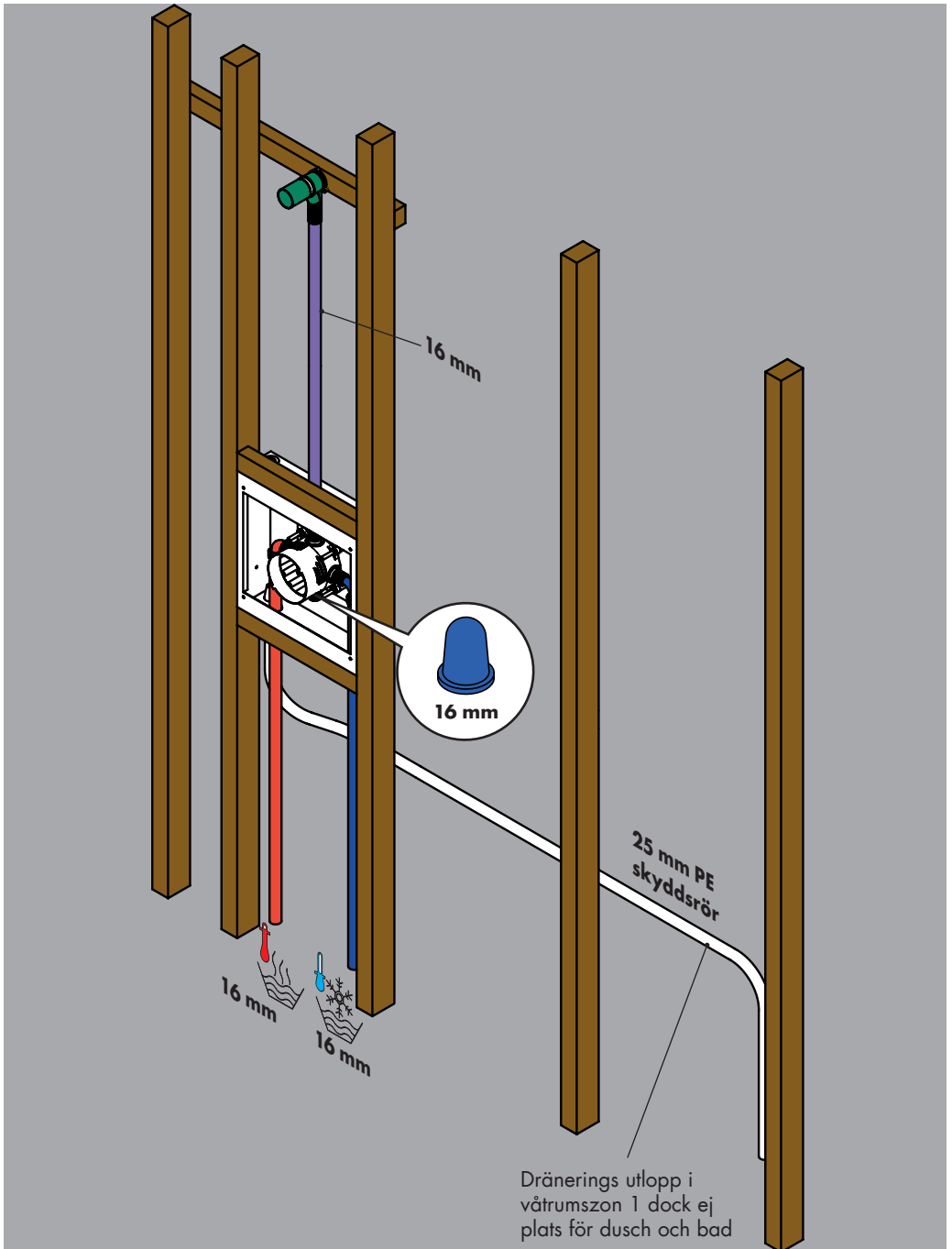

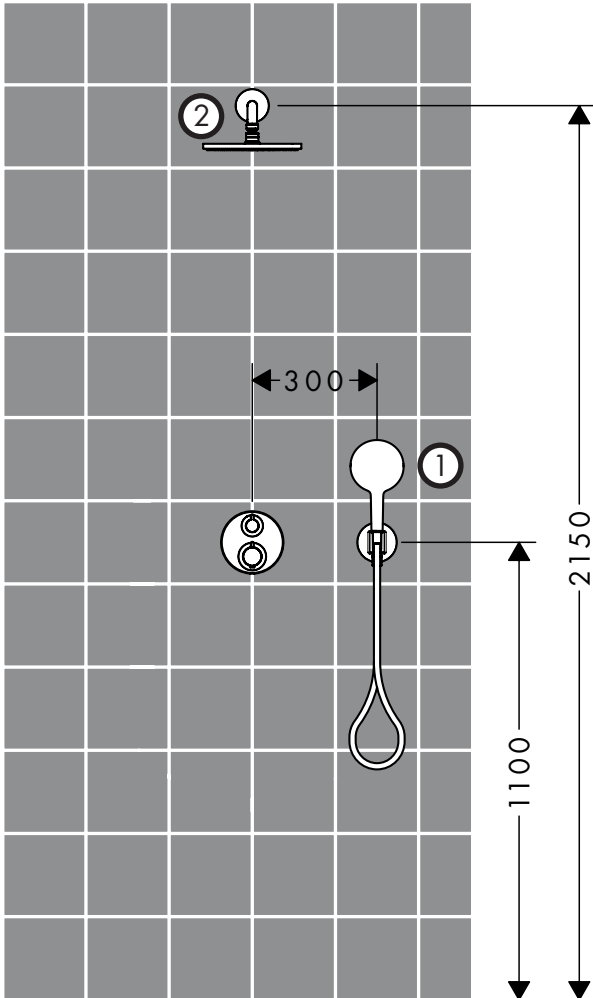
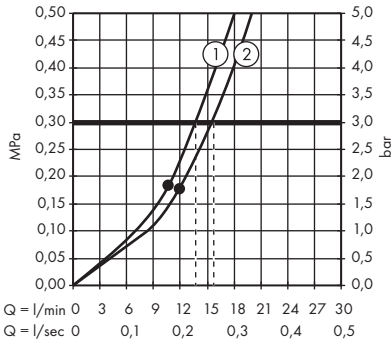
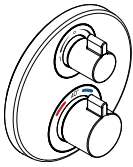

Ecostat S

15758000
RSK 8310282

Raindance S 240 Air 1jet

27474000
RSK 8184286

Raindance Select S 120 3jet

26530000
RSK 8376814

Isiflex 1,60 m

28276000
RSK 8377181

Fixfit Porter S

26487000
RSK 8310371

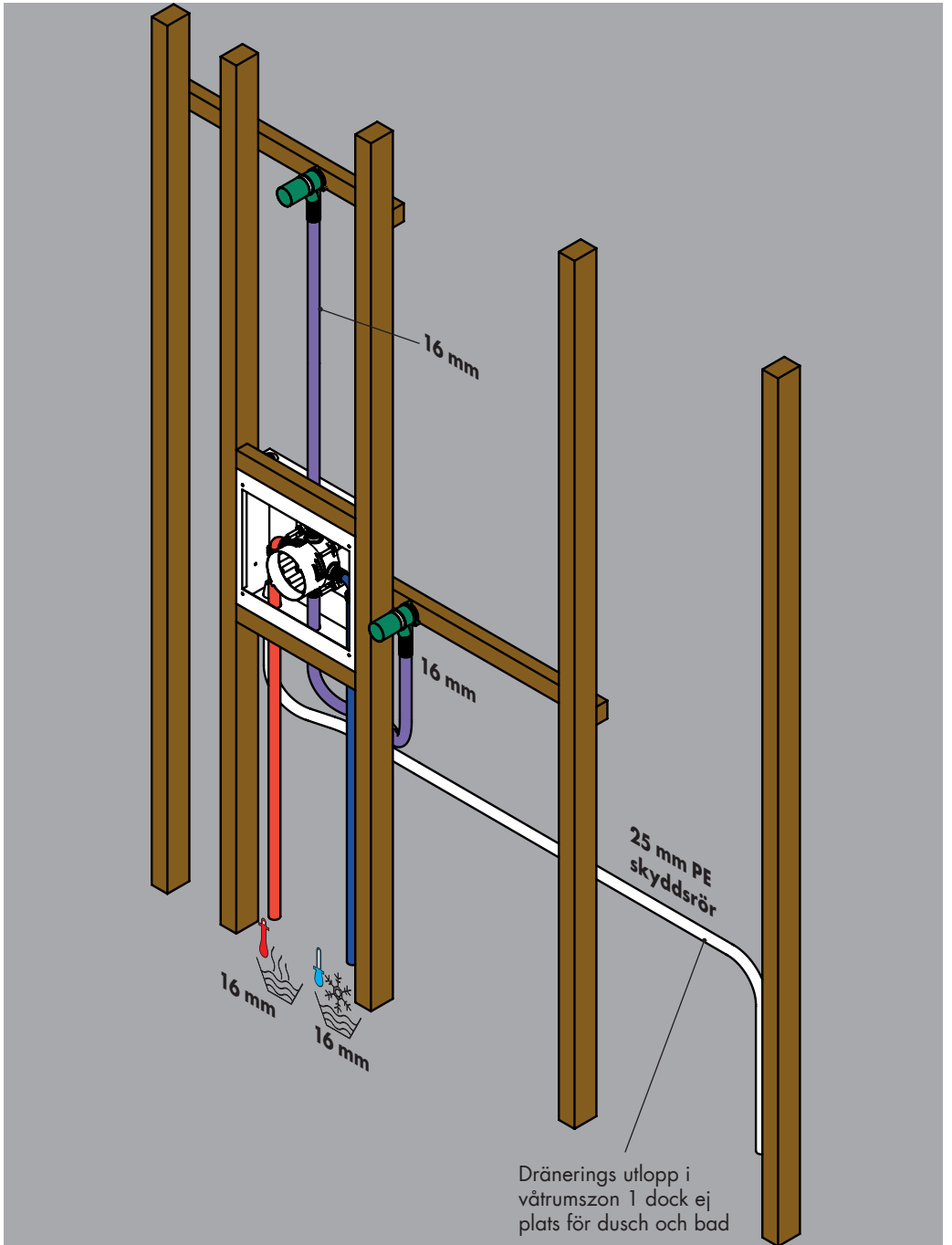

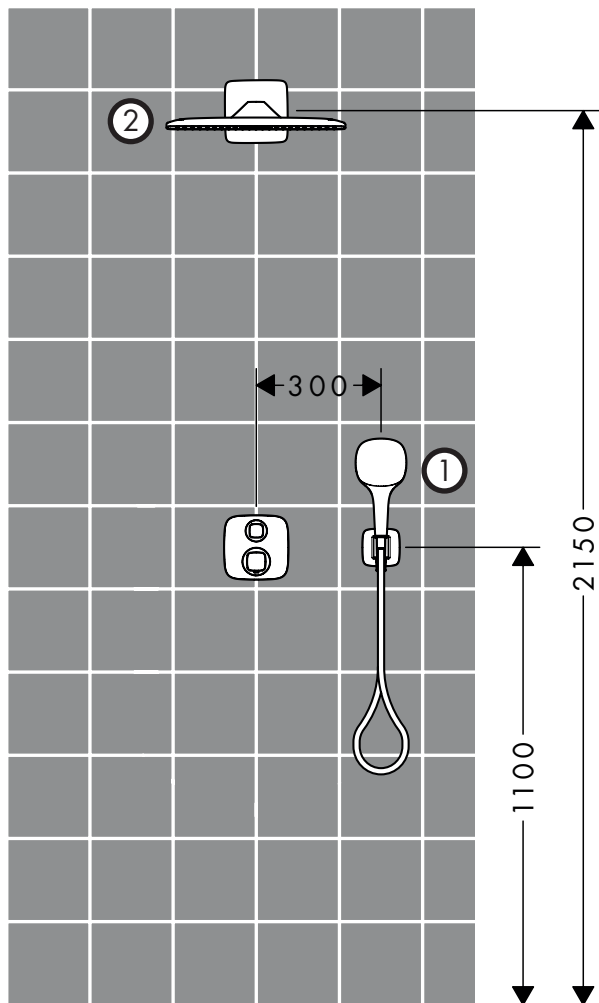
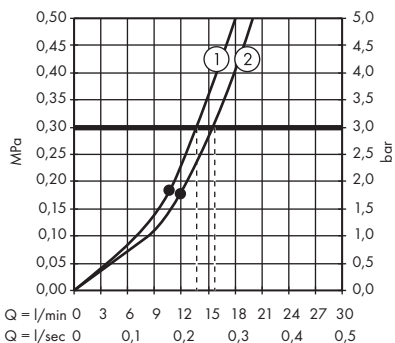
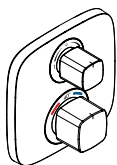

Ecostat E

15708000
RSK 8310293

Raindance E 420 Air 1jet

27372000
RSK 8184358

Raindance Select E 120 3jet

26520000
RSK 8376810

Isiflex 1,60 m

28276000
RSK 8377181

Fixfit Porter E

26485000
RSK 8310369

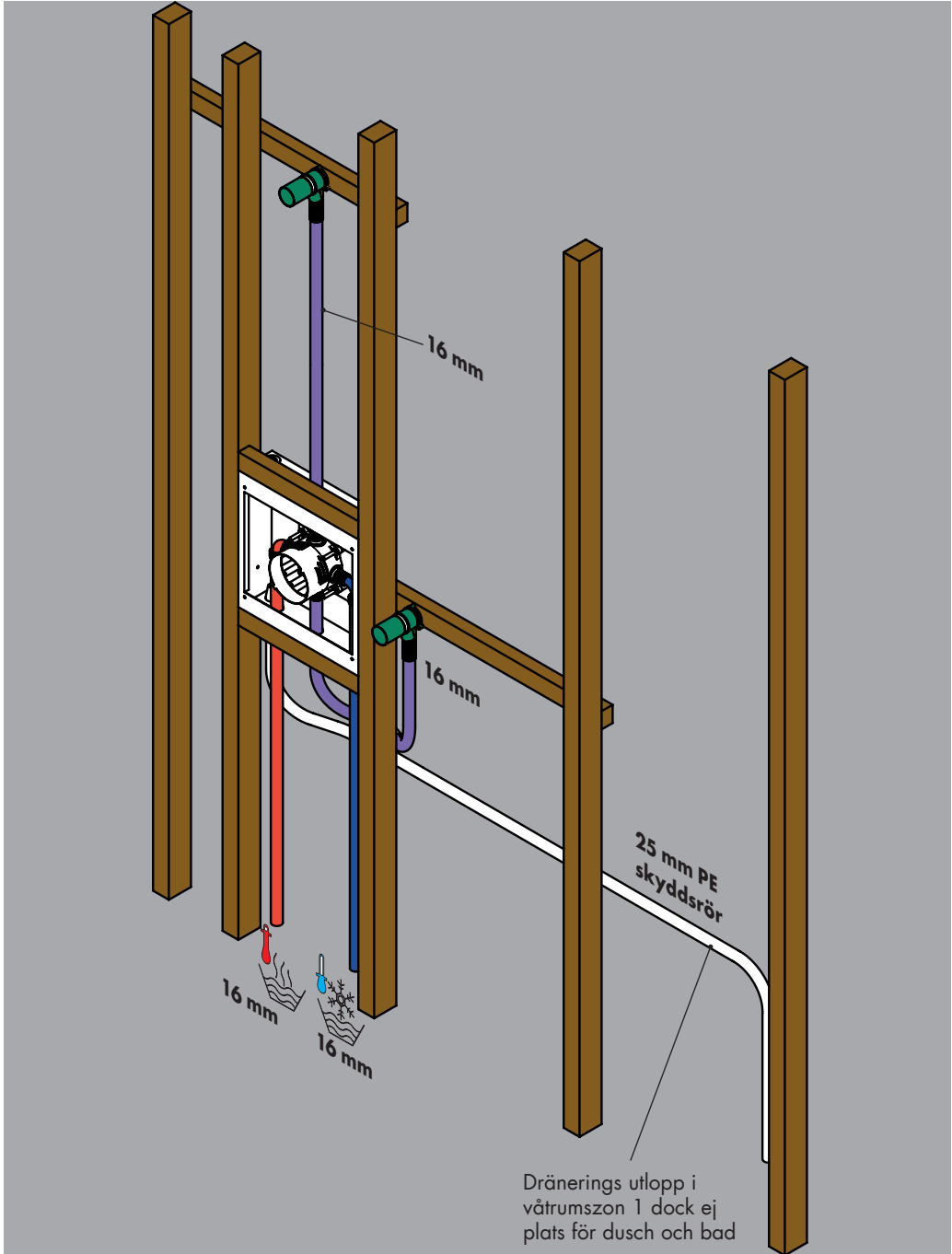

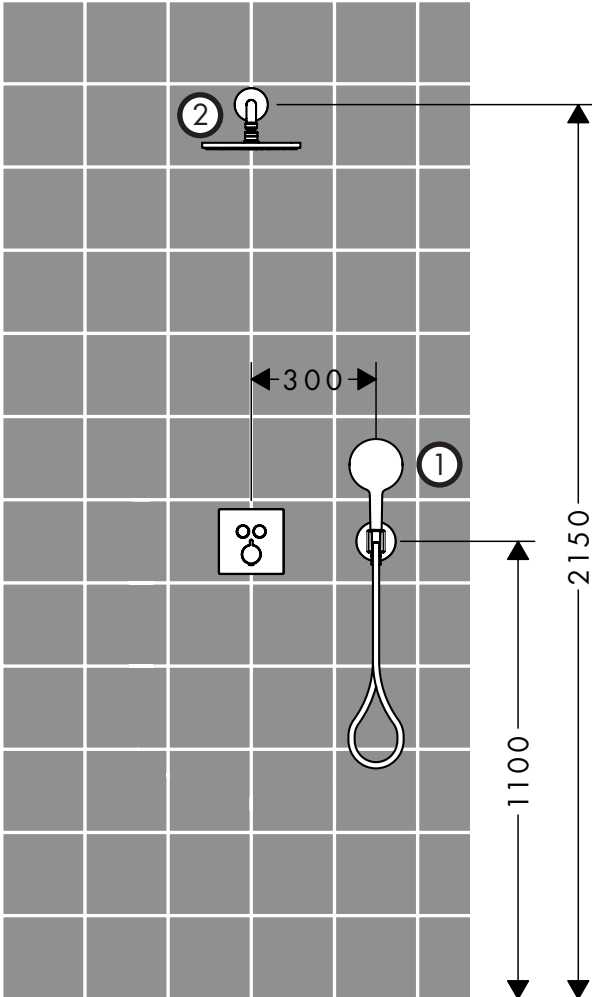
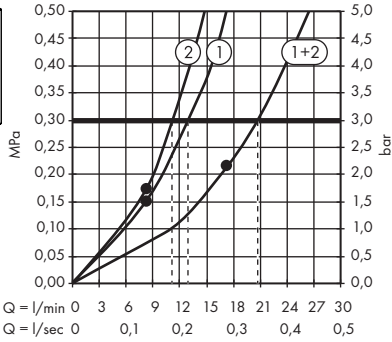
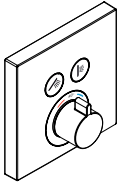

ShowerSelect

15738600
RSK 8310373

Raindance S 240 Air 1jet

27474000
RSK 8184286

Raindance Select S 120 3jet

26530000
RSK 8376814

Isiflex 1,60 m

28276000
RSK 8377181

Fixfit Porter S

26487000
RSK 8310371

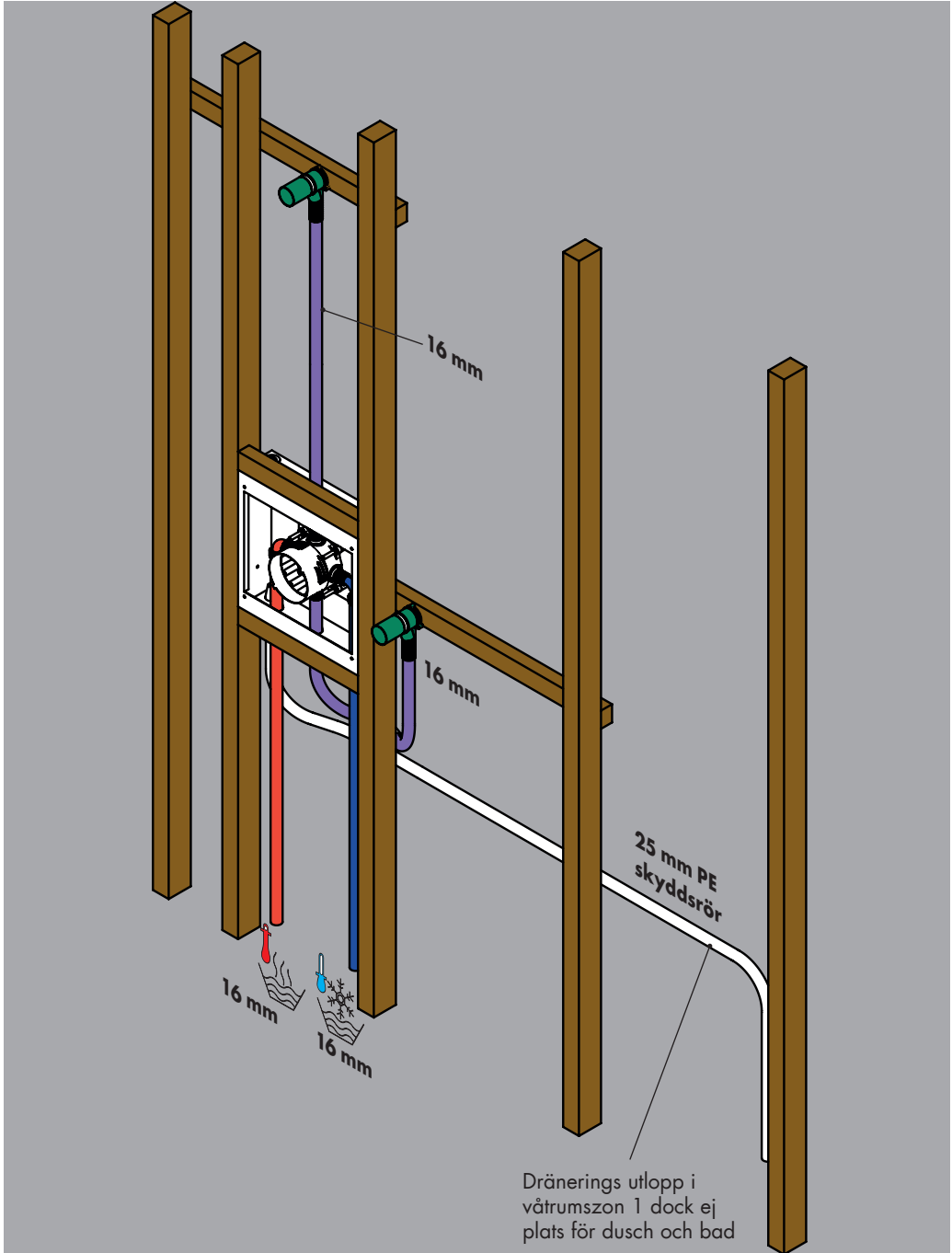

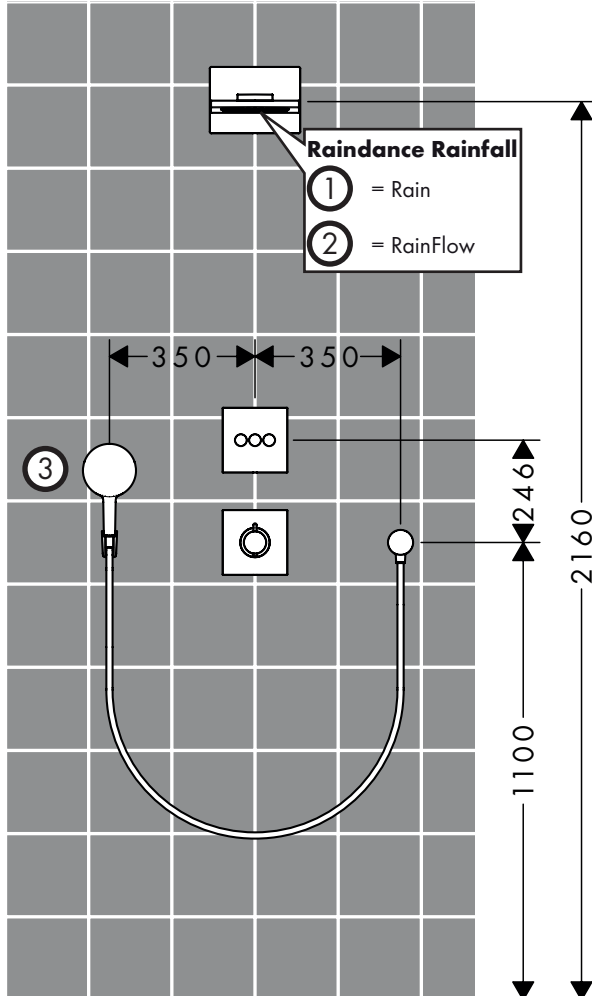
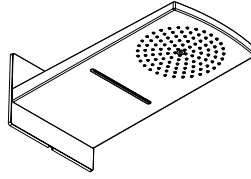
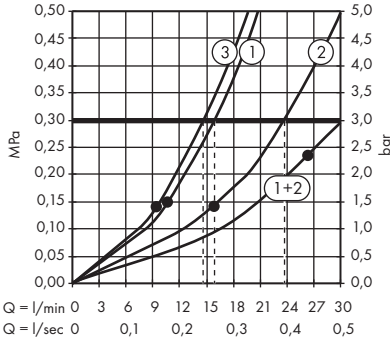
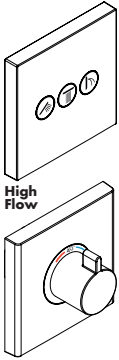

Raindance Rainfall

① = Rain

② = RainFlow

ShowerSelect Highflow

15760000
RSK 8310220

ShowerSelect 3x

15764000
RSK 8310224

Raindance Rainfall 180 Air 2jet

28433000
RSK 8184290

Raindance Select S 120 3jet

26530000
RSK 8376814

Isiflex 1,60 m

28276000
RSK 8377181

Porter S

28331000
RSK 8378315

Fixfit PuraVida

26485000
RSK 8310369

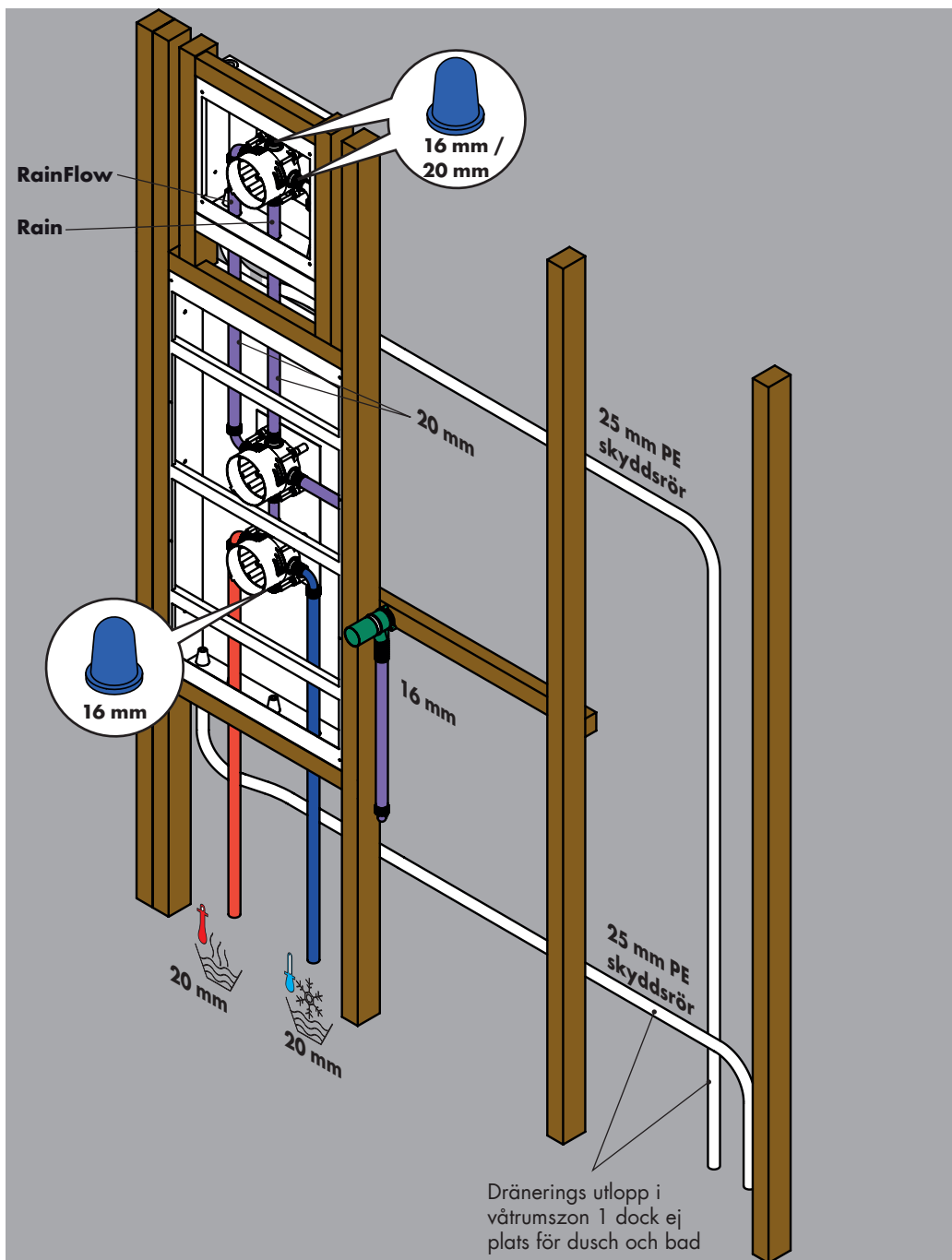

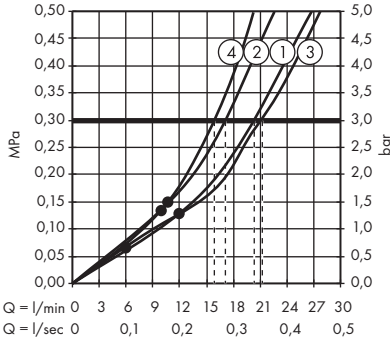
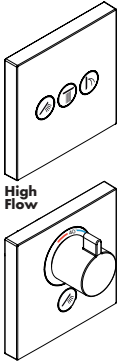

Raindance Select 460 3jet

- ① = Mono
- ② = RainStream
- ③ = Rain

350

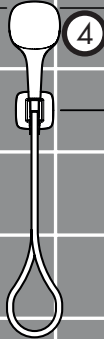

④

246
2200

1100

ShowerSelect Highflow

15735400
RSK 8310374

ShowerSelect 3x

15736400
RSK 8310375

Rainmaker Select 460 3jet

24006400
RSK 8184359

Rainmaker Select 460, 100mm

24010180
RSK 8310376

Raindance Select E 120 3jet

26520400
RSK 8376811

Isiflex 1,60 m

28276000
RSK 8377181

Fixfit Porter Square

26486000
RSK 8310370

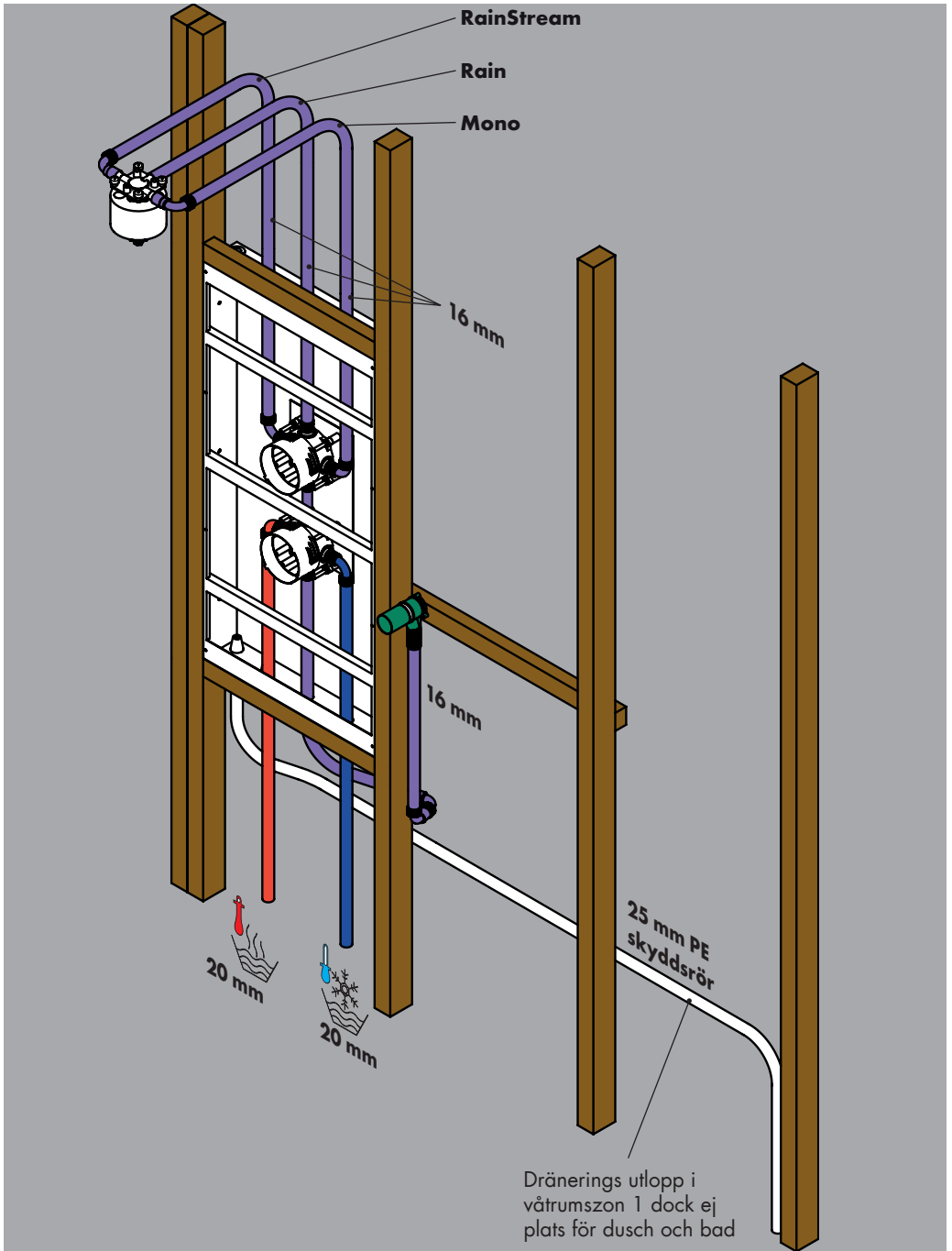

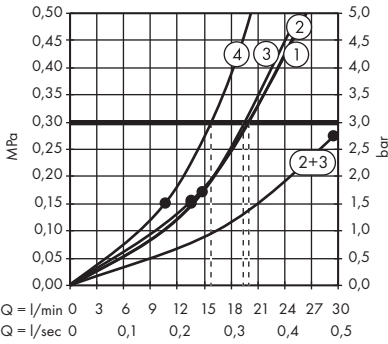
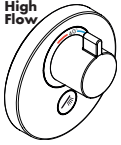
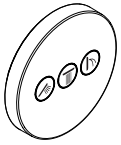

Raindance Rainmaker

- ① = RainAir
- ② = WhirlAir
- ③ = RainAir XXL

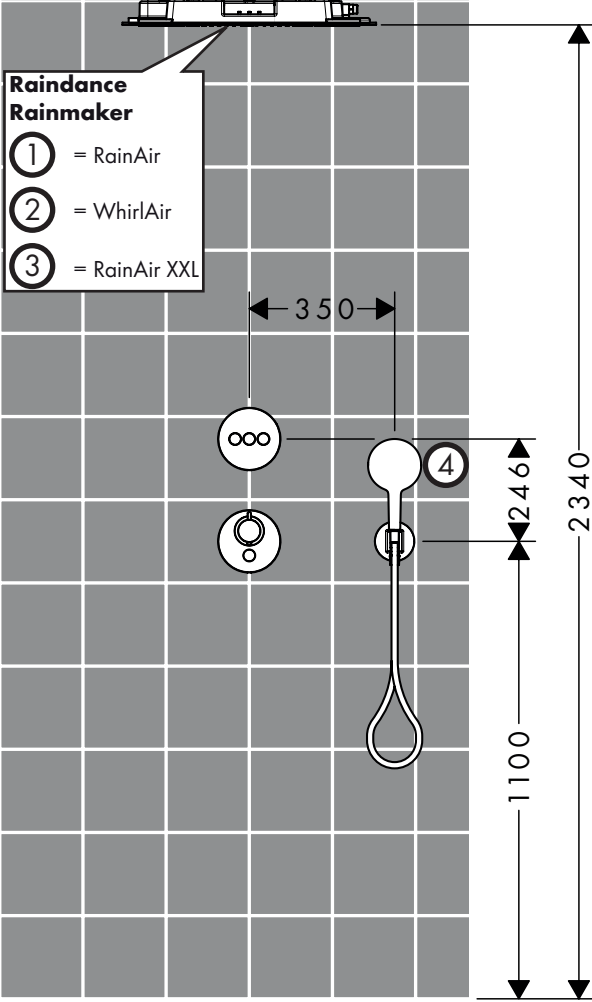

ShowerSelect S

15742000
RSK 8310291

ShowerSelect S 3x

15745000
RSK 8310288

Raindance Rainmaker 600 mm

26115000
RSK 8184353

Raindance Rainmaker

28412180
RSK 8310306

Raindance Select S 120 3jet

26530000
RSK 8376814

Isiflex 1,60 m

28276000
RSK 8377181

Fixfit Porter S

26487000
RSK 8310371

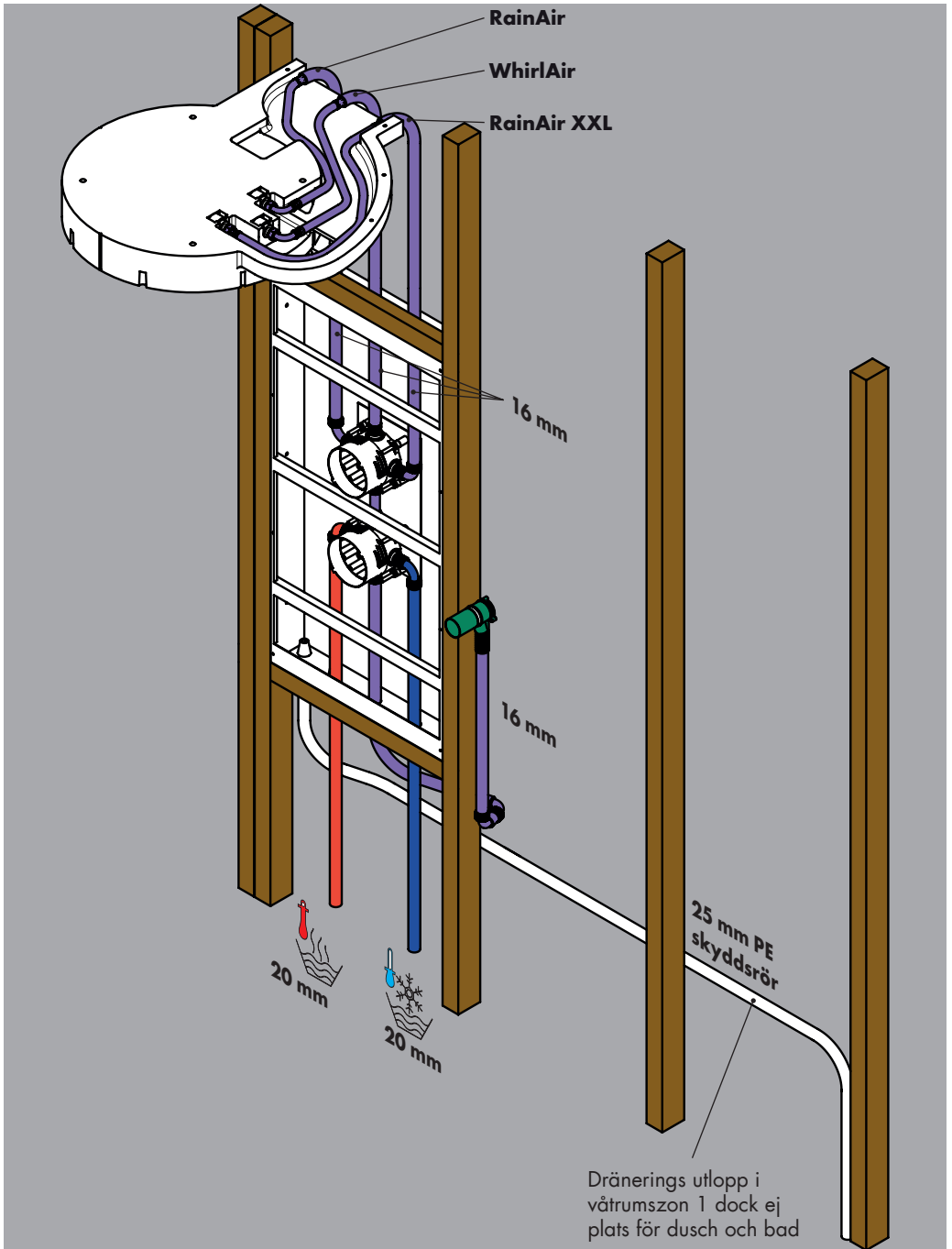



Våtrumsinnervägg keramik

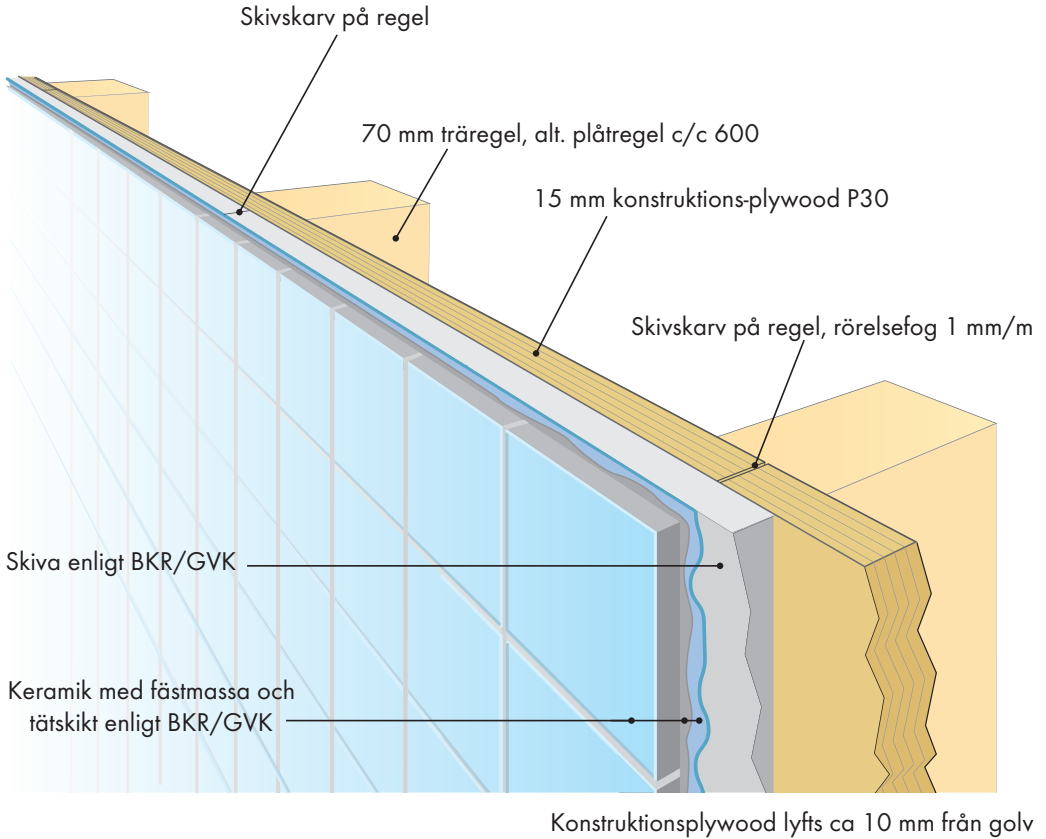

Hinweis!

Dieser spezielle Wandaufbau ist nur in Schweden notwendig.

Note!

This special wall installation is only necessary in Sweden.

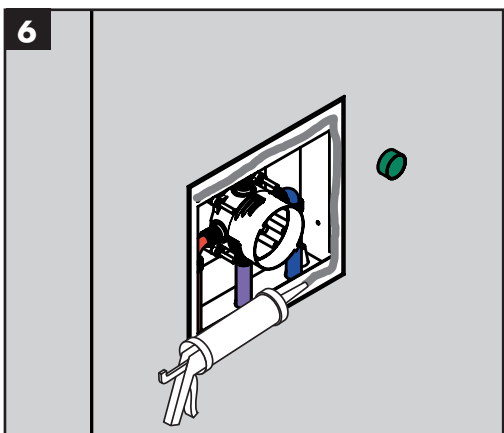
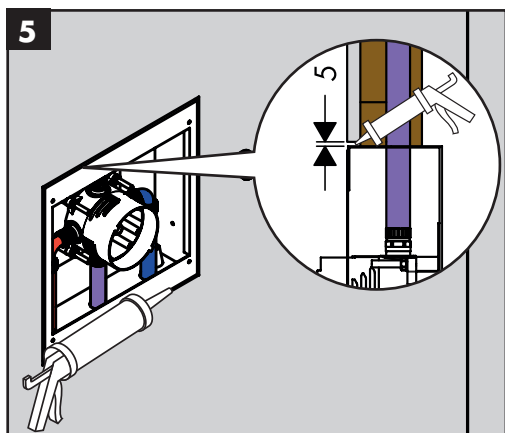
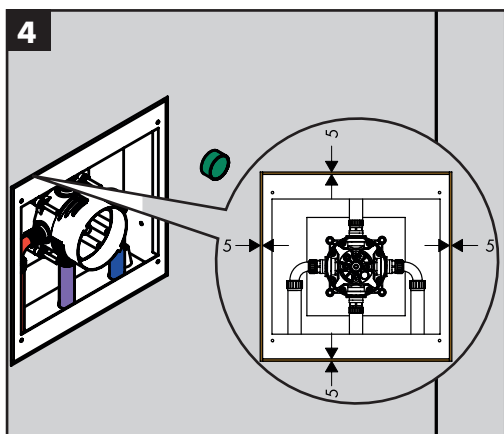
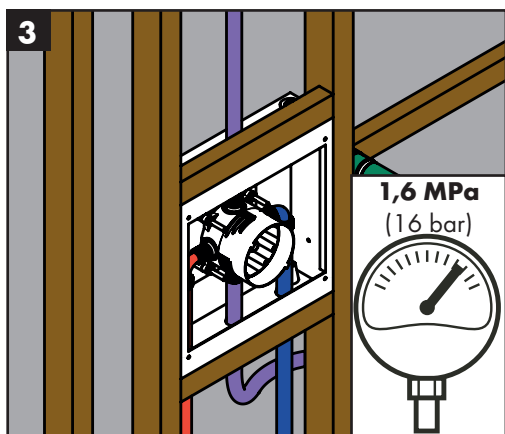
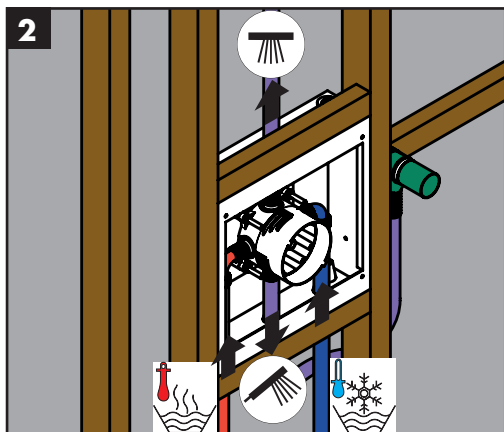
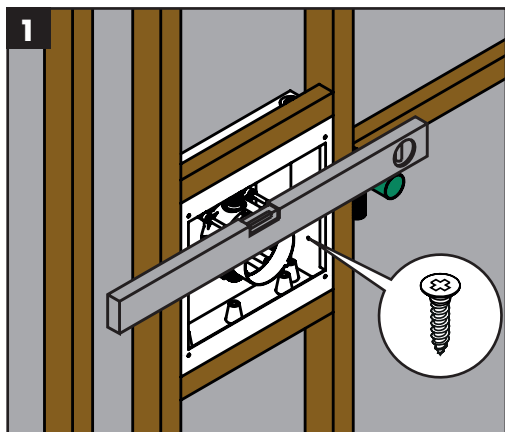

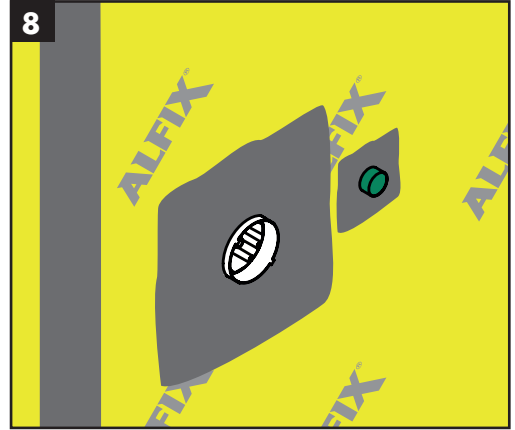
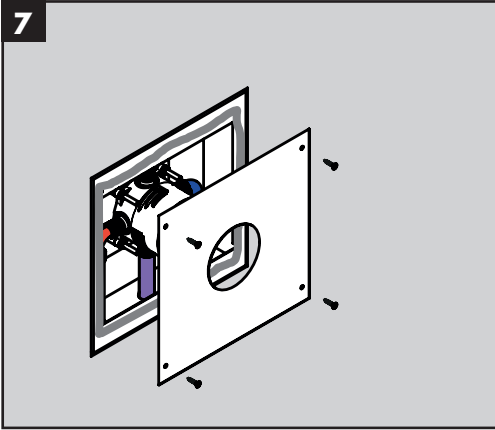

Våtrum

Tätskikt med Alfix rollade system



http://www.alfix.com/files/pdf/pdf_printfiler_se/se_rolladesystem.pdf



Våtrum

Tätskikt med Alfix folie system

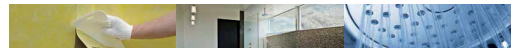

http://www.alfix.com/files/pdf/pdf_printfiler_se/se_foliesystem.pdf

Vådtrum

Vandtætning med Alfix

http://www.alfix.com/files/pdf/pdf_printfiler_dk/dk_vaadrumsbrochure.pdf

Våtrum

Vannetting med Alfix

http://www.alfix.com/files/pdf/pdf_printfiler_no/no_vaadrumsbrochure.pdf

Wetrooms

Tanking with Alfix

http://www.alfix.com/files/pdf/pdf_printfiler_gb/gb_vaadrumsbrochure.pdf

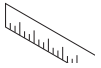

RSK: 8310344 HG#01820180

RSK: 8236121 GF#200 119 151

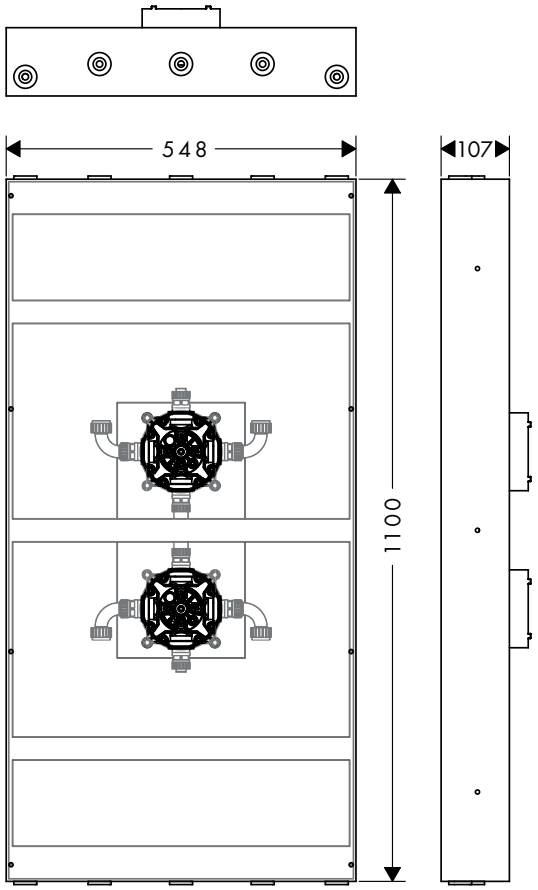
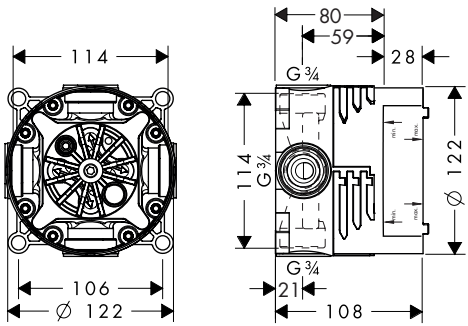

RSK: 8236120 GF#200 119 150

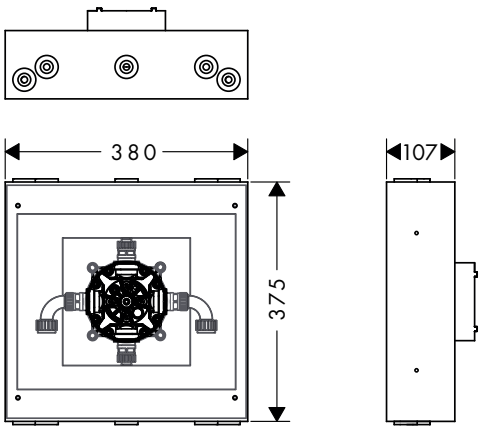

Länk till Georg Fischer AB

http://www.gfps.com/content/gfps/country_SE/sv.html

Länk till nedladdning av Sanipex installation.

http://www.gfps.com/content/gfps/country_SE/sv/support_and_services/downloads/teknisk-information.html

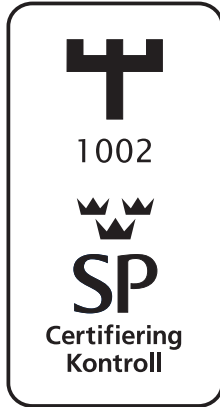

hansgrohe