

VG6000 Series Forged Brass Valves

Product Bulletin

PB_VG6000
Issue Date 04 2008

The VG6000 forged brass valve series is primarily designed to regulate the flow of water in response to the demand of a controller in zone and terminal unit applications and can be used in combination with VA-703x Thermal ON/OFF Actuators and VA-747x Electronic Terminal Unit Valve Actuators.

The valves are available in 2-way PDTC (Normally Open), 3-way mixing and 3-way mixing with built-in bypass configurations.

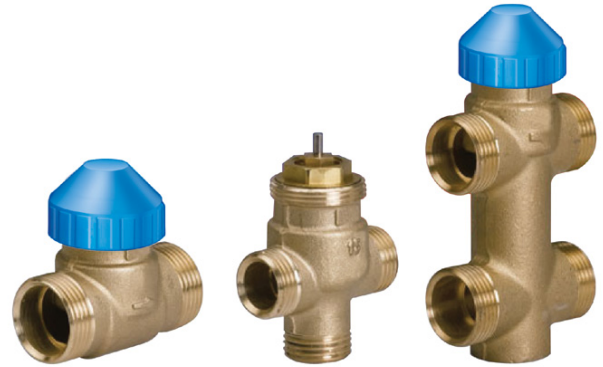

VG6000 Valves

Table 1: Features and Benefits

Features	Benefits
2-way PDTC (NO) and 3-way configurations	Flexible applications
3-way with built-in bypass configuration	Reduces piping installation time and cost
3-way valves designed for mixing and diverting application	Wide range of application
Suitable for VA-703x and VA-747x Series Actuators	Allows valve operation with the most common controller outputs
Forged brass body, stainless steel stem and spring	Ensure long life and it is compact
Rubber compound plug for bubble-tight shut-off	Maximises energy saving
Actuator can be field installed after piping	Simplifies installation in confined location
Commissioning Cap	Easy commissioning and manual operation without actuator
Built-in return spring	Allows the valve to return to normal position when actuator is not mounted or when VA-703x Actuator is de-energised

Ordering Codes and Dimensions

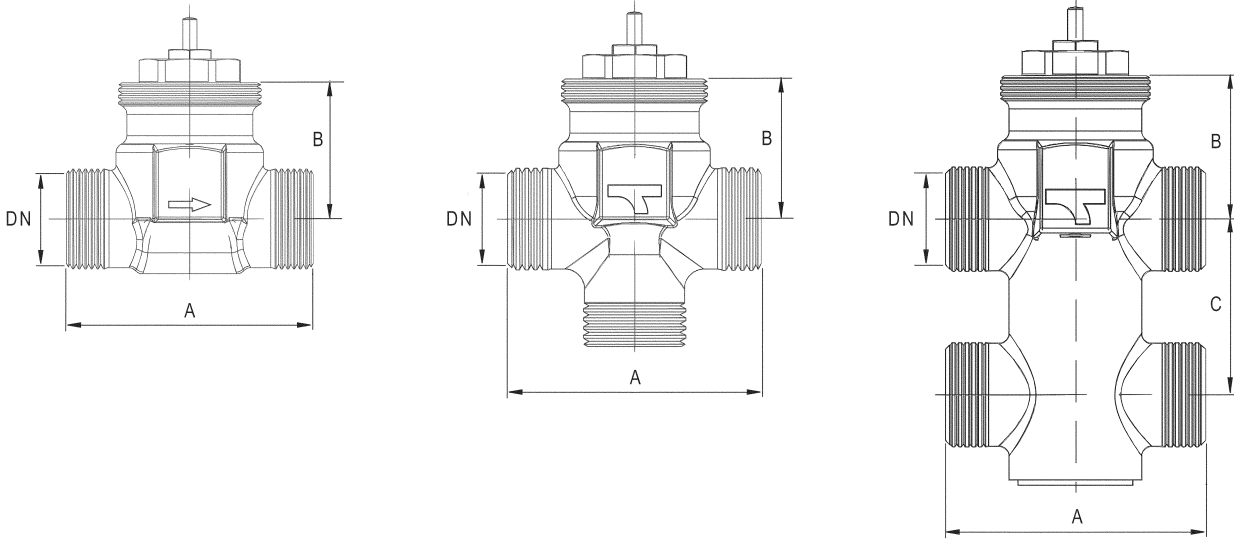

Ordering Codes	Body Type	Body Size	Kvs Control Port	Kvs Bypass Port	Close-Off Pressure (kPa)	Dimensions (mm)		
						A	B	C
VG6210EC	2-way PDTC (NO)	DN15	1.7	-	250	52	29	-
VG6210JC		DN20	2.6	-	150	56	28	-
VG6210LC		DN25	4.5	-	70	82	30.5	-
VG6810EC	3-way Mixing / Diverting	DN15	1.7 Mixing 1.7 Diverting	1.2 Mixing 1.3 Diverting	200	52	29	-
VG6810JC		DN20	2.5 Mixing 2.6 Diverting	1.6 Mixing 1.8 Diverting	100	56	28	-
VG6810LC		DN25	4.5 Mixing 4.5 Diverting	3.1 Mixing 3.1 Diverting	70	82	30.5	-
VG6510EC	3-way with built-in by-pass Mixing / Diverting	DN15	1.7 Mixing 1.7 Diverting	1.2 Mixing 1.3 Diverting	200	52	29	40
VG6510JC		DN20	2.5 Mixing 2.6 Diverting	1.6 Mixing 1.8 Diverting	100	56	28	40
VG6510LC		DN25	4.5 Mixing 4.5 Diverting	3.1 Mixing 3.1 Diverting	70	82	30.5	74

Valve Selection

The valve size for water applications can be defined using the diagrams below.

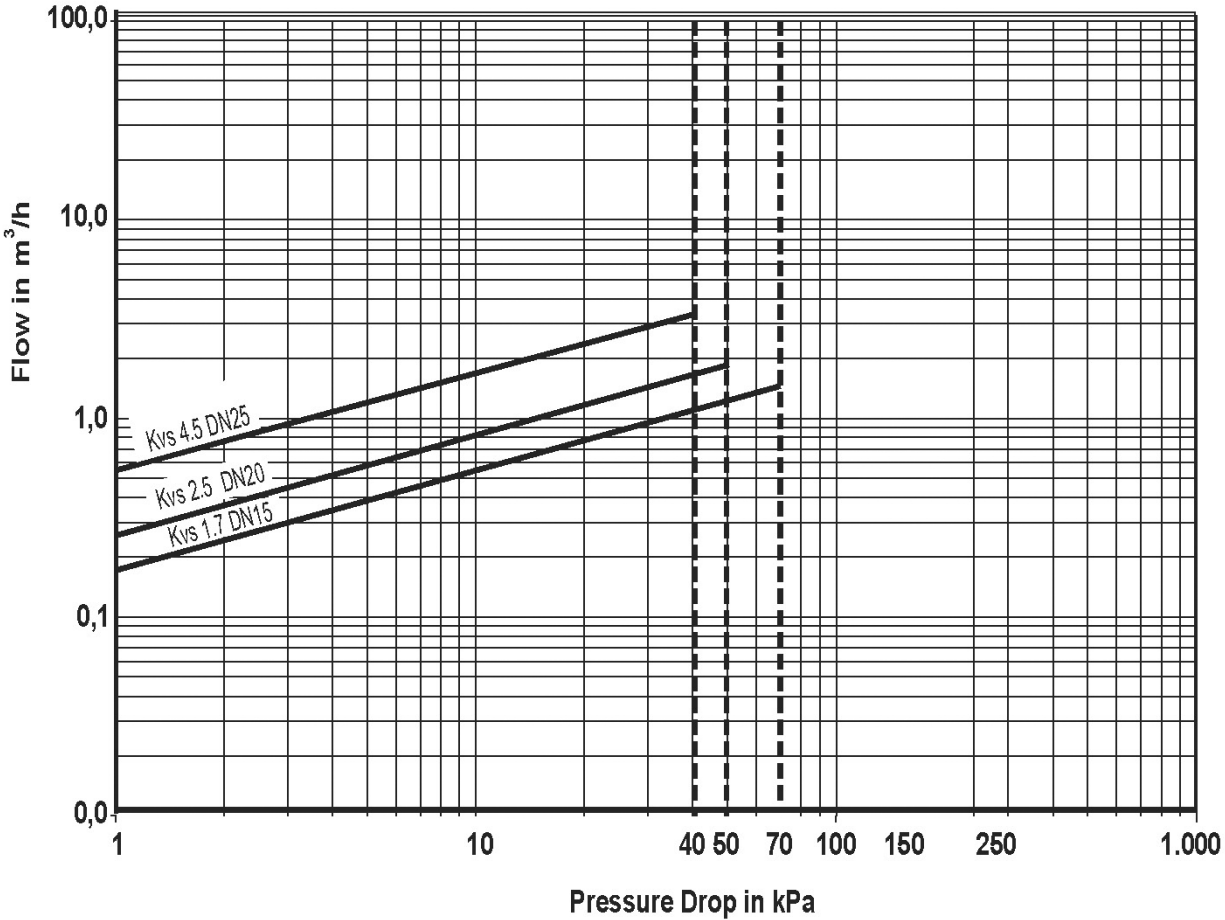

Kvs selection diagram in SI units

Valve - Actuators Combinations

The VG6000 series valves are designed to be used with following actuators:

VA-7030 Electrothermic Actuators







Item code	Action	Auxiliary Switch	Supply voltage
VA-7030-21NO	Direct Acting (stem extends when actuator is energized)	---	24 VAC / VDC
VA-7035-21NO		X	
VA-7030-21NC	Reverse Acting (stem retracts when actuator is energized)	---	
VA-7035-21NC		X	
VA-7030-23NO	Direct Acting (stem extends when actuator is energized)	---	230 VAC / VDC
VA-7035-23NO		X	
VA-7030-23NC	Reverse Acting (stem retracts when actuator is energized)	---	
VA-7035-23NC		X	

VA-747x Electric Actuators

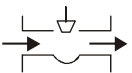
Item code	Control Type	Supply voltage
VA-7470-1001	Floating	24 VAC
VA-7472-1001	Proportional	
VA-7472-9001	Direct Acting (stem extends when increased input signal)	

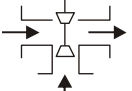
See "VA-703x Electro-thermic Actuator" and "VA-747x Electronic Terminal Unit Valve Actuator" Product Bulletins for more information.

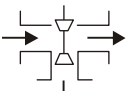
Operation

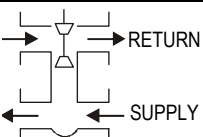
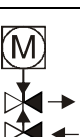
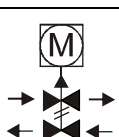
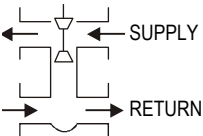
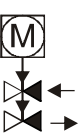
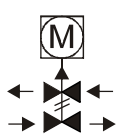
Valve Type	Stem Movement / Flow	
	Actuator Stem down	Actuator Stem up
 2-Way PDTC (NO)		
 3-Way MIXING		
 3-Way DIVERTING		
 3-Way + bypass		
 3-Way + bypass		

Operation

These valves are used for hot or cold water and for water glycol mixtures up to 50%.

Note: These valves are intended to control equipment under normal operating conditions. Where failure or malfunction of the valves could lead to an abnormal operating condition that could cause personal injury or damage to the equipment or other property, other devices (limit or safety controls) or systems (alarm or supervisory systems) intended to warn of or protect against failure or malfunction of the valves must be incorporated into and maintained as part of the control system.

Mounting Instructions

General Guidelines

In addition to general installation instructions, please observe the following points:

- Ensure that valve body and piping are free of impurities.
- Pay attention to position of the valve relative to the flow direction.
- Note flow symbols on valve body.
- Ensure that threaded connections of valve and piping are tighten.
- Ensure installation without tension and torque.
- Do not use the valve as a step or fixation point. Only piping supports it.
- Protect valve from dust or dirt on construction sites.
- Provide strainer or filter upstream of valve.
- Use compensators to balance thermal expansion of piping.
- Ensure that stem thread and shaft are kept free of paint.

Installation Site Information

The valve installation site should be easily accessible and provide sufficient room for service and removal of actuators. Manual shut-off valves should be located up and downstream of the control valve, to facilitate service and repairs without drainage of the piping system. The control valve should preferably be installed in vertical or horizontal position.

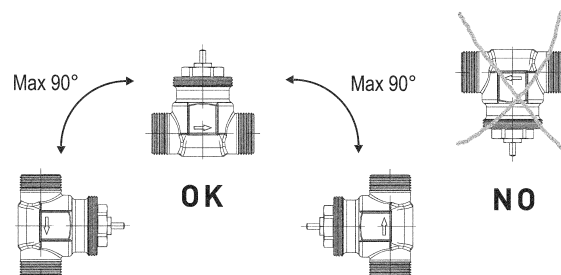

Piping should be insulated to protect actuators against high temperatures. Insulation should leave sufficient room for service of stem packing. To ensure trouble free function of the control valves the pipe immediately upstream of the valve should be straight for the length of at least 2x DN and the pipe immediately downstream straight for the length at least 6x DN.

Commissioning

Prior to commissioning check information on material, pressure, temperature and flow direction in conjunction with the installation piping system plan. Impurities in the piping system and valves, such as dirt, welding beads etc. will cause the system to leak. Prior to commissioning a new installation or re-commissioning after repairs or service, ensure that:

- Correct installation and assembly work has been completed.
- Only qualified personnel carry out commissioning.
- Correct functional position of the valve is ascertained.
- Maintenance of existing protective facilities is carried out.

Valve Removal

In addition to general guidelines the following points should be observed:

- Pressure free piping system
- Cooled fluid
- Drained piping system
- With corrosive or aggressive fluids, the piping system should be vented.

Work to be performed by qualified personnel only.

Technical Specifications

Products	VG6000		
Models	VG6210...	VG6810...	VG6510...
Body Type	2-way PDTC (NO)	3-way mixing/diverting	3-way mixing diverting with built-in by-pass
Body Rating	PN16 Nominal, maximum rated pressure		
Inherent Flow Characteristic	Quick Opening		
Service	Water, glycol solutions (max 50%) for HVAC applications. Fluid Group 1 according 67/548/EEC. (proper water treatment is recommended, refer to VDI 2035)		
Body Size	DN15 DN20 DN25		
Max Pressure drop Δp	DN15: 70 kPa DN20: 50 kPa DN25: 40 kPa		
Kv_s and max. close-off pressure	See "Ordering Code and Dimensions" on page 2		
Body Connecticus	Gas BSP Parallel (ISO 228/1, BS 2779, DIN 259)		
Nominal Stroke	2.5 mm		
Connection to Actuator	M30 x 1.5		
Materials	Body: EN12165 CW617 Brass CuZn40Pb2 Trim: Stem: AISI 303 stainless steel (X10CrNiS1809) Spring: AISI 302 stainless steel (X10CrNi1809) Plug: EPDM		
Leakage	Max 0,01% of KVS, Class IV for ANSI FCI 70-2 and EN60534-4 modif. 1		
Fluid Temperature Limits	2...110 °C		
Ambient Temperature Limits	2...50 °C		
Max weight packaging excluded	2-way NO	3-way mixing / diverting	3 way mixing / diverting + built-in bypass
	DN15	200g	200g
	DN20	200g	250g
	DN25	500g	550g
CE Compliance	PED (Pressure Equipment Directive) 23/97/CE (Paragraph 3, comma 3) CE marking is not applicable. ROHS (95/2002/CE)		

The performance specifications are nominal and conform to acceptable industry standards. For application at conditions beyond these specifications, consult the local Johnson Controls office. Johnson Controls, Inc. shall not be liable for damages resulting from misapplication or misuse of its products.

Johnson Controls International, Inc.

Headquarters: Milwaukee, Wisconsin, USA

Branch Offices: Principal Cities World-wide

