

■ Pipe clamp HDC 30x2,5 31 - 35 mm M10 unlined

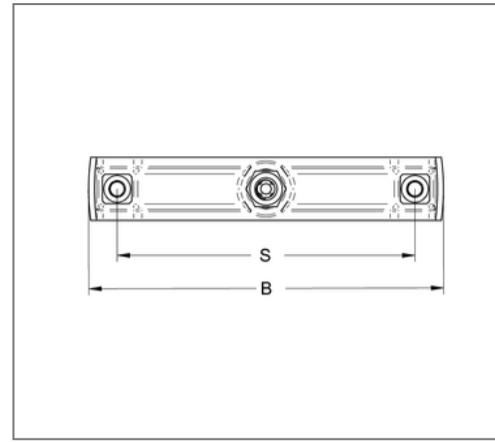
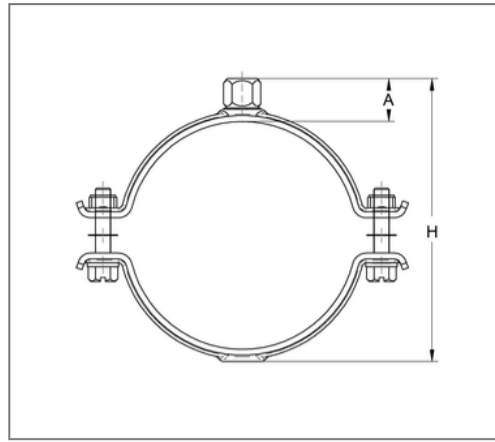

Commercial details

Part no.	47300034
EAN/GTIN	4250928458223
Packing unit	50 pcs
Price unit	100
Quantity unit	pcs
Weight	0,155 kg/pc
Product group	12-034

QR code



Certification



Specification

Brand	Jiangmen Eurofix
Application	Pipe clamp with connection thread according to area sprinkler guidelines for Sprinkler systems.
Specification	two-part
Connection	M10

Technical data

Material	Steel
Surface	galvanized
Sound insulation lining	unlined

Product details

Center distance	55 mm
Connection height	18 mm
Width	77 mm
Height	57 mm
Material dimension	30x2.5 mm
Width material	30 mm
Material thickness	2.5 mm
load Fz	2.5 kN
min. outside pipe diameter	31 mm
max. outside pipe diameter	35 mm
Outside pipe diameter inch	1 inch
Closure screw	M10