

■ Pipe clamp HDC 30x3 88 - 93 mm M10 unlined

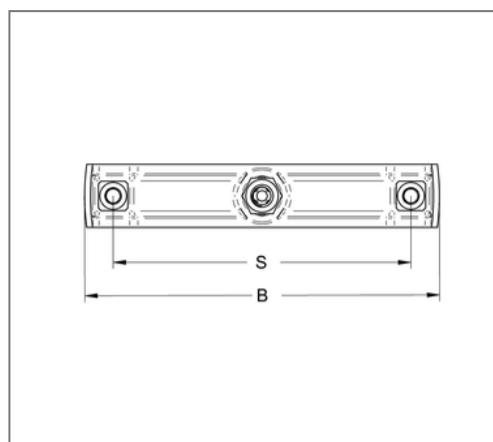
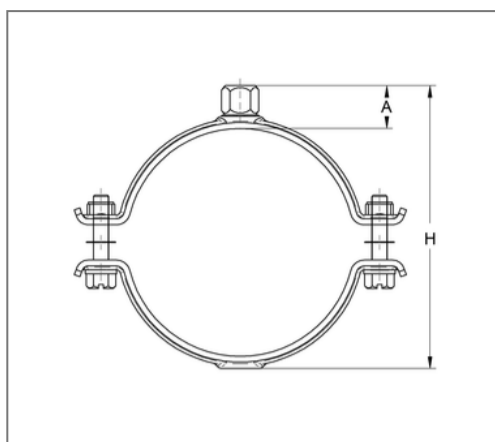

Commercial details

Part no.	47300088
EAN/GTIN	4250928458278
Packing unit	25 pcs
Price unit	100
Quantity unit	pcs
Weight	0,319 kg/pc
Product group	12-034

QR code



Certification



Specification

Brand	Jiangmen Eurofix
Application	Pipe clamp with connection thread according to area sprinkler guidelines for Sprinkler systems.
Specification	two-part
Connection	M10

Technical data

Material	Steel
Surface	galvanized
Sound insulation lining	unlined

Product details

Center distance	120 mm
Connection height	20 mm
Width	147 mm
Height	117 mm
Material dimension	30x3 mm
Width material	30 mm
Material thickness	3 mm
load Fz	3.5 kN
min. outside pipe diameter	88 mm
max. outside pipe diameter	93 mm
Outside pipe diameter inch	3 inch
Closure screw	M10