

## ■ Clamping bow M10 C-profile 45 Profile height 26 - 60 Clamping thickness 26 mm

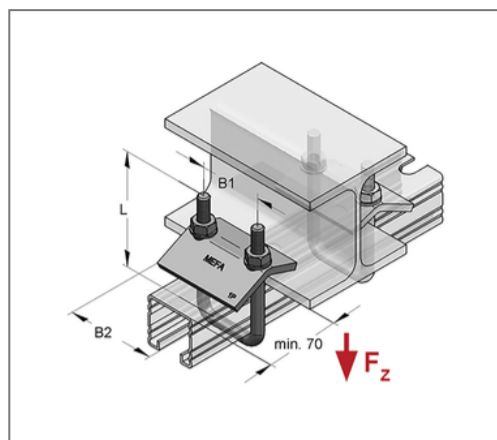
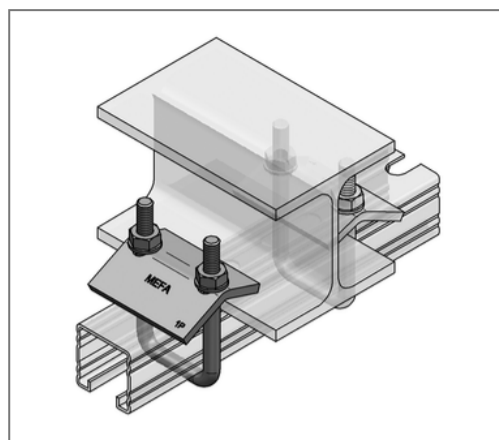

### Commercial details

Part no.	0816720
EAN/GTIN	4250928420466
Packing unit	20 pcs
Quantity unit	pcs
Weight	0,401 kg/pc
Product group	02-081
Price unit	1

### QR code



### Specification

Application area	for mounting of C-profile rail on steel girder
Profile type	45

### Technical data

Material	Steel
Material type	ST 36 FK 4.6
Surface	galvanized

### Product details

load $F_z$	4 kN
Thread	M10
max. clamping thickness	26 mm
Tightening torque	15 Nm
Profile height	26 - 60 mm
Center distance U-bolt B1	56 mm
Width tensioning bracket B2	80 mm
Length U-bolt L	100 mm
min. edge distance	70 mm