

■ Stex 45 Threaded bolt GB M8 x 110 mm

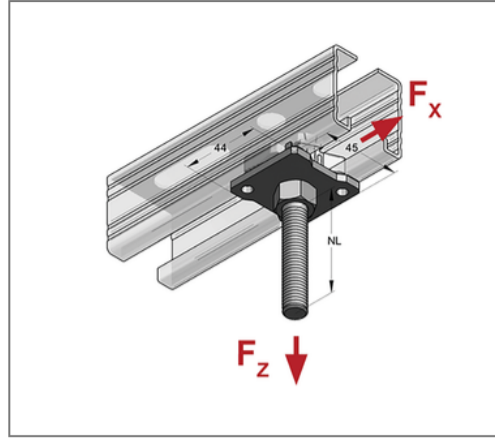
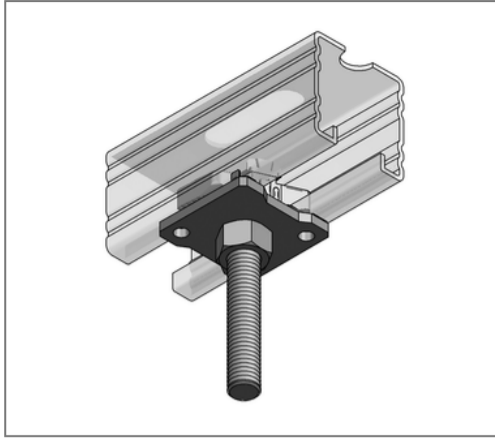

Commercial details

Part no.	1281110
EAN/GTIN	4250928424761
Packing unit	20 pcs
Quantity unit	pcs
Weight	0,154 kg/pc
Product group	02-128
Price unit	1

QR code



Specification

Application area	quick-fixing system for direct pipe clamp attachment to Stex profile rails with permanently integrated threaded bolt and nut.
------------------	---

Technical data

Material	Steel
Material type	S235
Surface	galvanized
Strength class	4.6

Product details

Thread	M8
Length thread	110 mm
Usable length	71 mm