

■ Pipe clamp Titan HD 50x5 133 mm 1/2" unlined

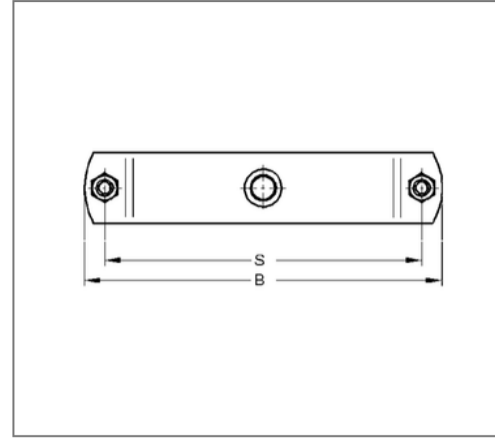
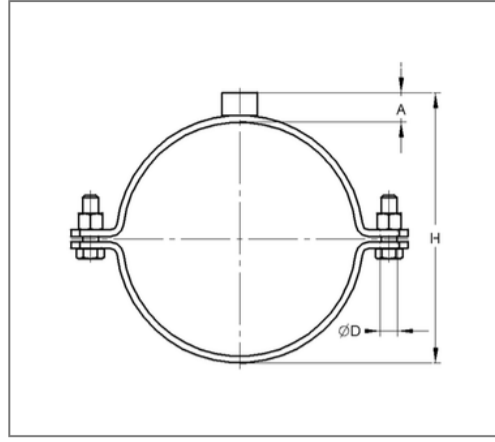
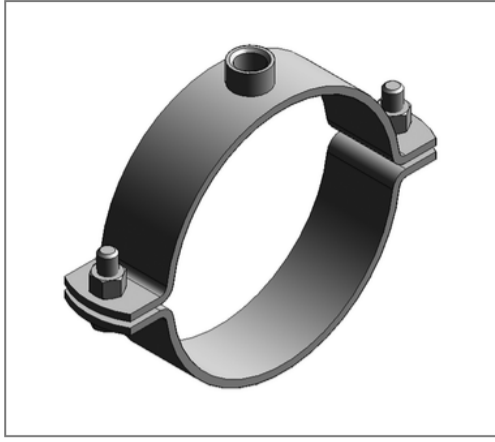

Commercial details

Part no.	0072584
EAN/GTIN	4250928403957
Packing unit	1 pcs
Price unit	100
Quantity unit	pcs
Weight	1,22 kg/pc
Product group	01-007

QR code

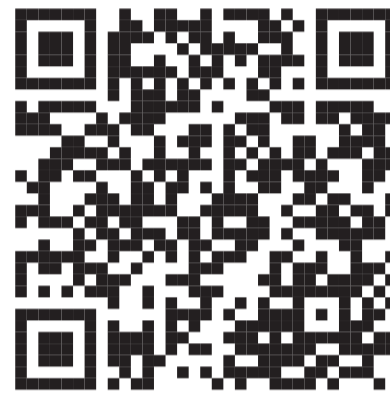

Certification



Specification

Application area	Pipe clamp for fastening pipes in the heavy load range.
Specification	two-part
Connection	1/2"
Closure	Screw coupling

Technical data

Material	Steel
Material type	S235
Surface	galvanized
Sound insulation lining	unlined

Product details

Center distance	183 mm
Connection height	20 mm
Width	212 mm
Height	158 mm
Material dimension	50x5 mm
load Fz	6 kN
Outside pipe diameter	133 mm
Closure screw	M12

Remark

Delivery time	5 - 8 working days ex works. Exchange and return are excluded.
---------------	--