

■ Insulated pipe clamp Husky IV 19 15 mm Insulation 17.5 M8/M10

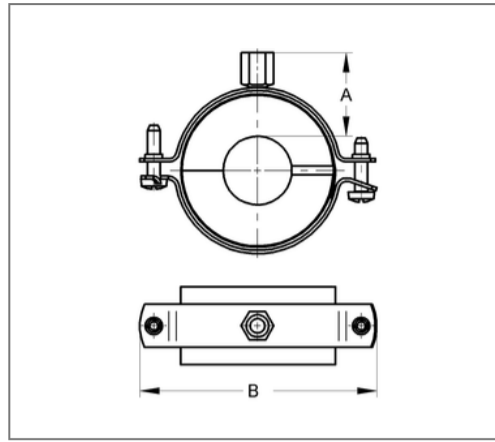

Commercial details

Part no.	6840150
EAN/GTIN	4250928440679
Packing unit	24 pcs
Price unit	1
Quantity unit	pcs
Weight	0,0934 kg/pc
Product group	06-684

QR code



Certification



Specification

Application area	A thermal decoupled mounting of tubes guarantees a reliable prevention of condensate for refrigeration, air-conditioning and drinking water technologies in the sector pipe-clamping
Insulation body	KA/PU

Technical data

Material	Steel
Material type	DD11
Material coat	Plastic
Surface	galvanized
Class	B2
min. temperature resistance	-45 °C
max. temperature resistance	105 °C
Thermal conductivity	0.029 W/mK
Density core	120 kg/m ³
Water vapour diffusion resistance	7000 μ

Product details

Connection	M8/M10
Connection height	37 mm
Width	88 mm
Insulation thickness	17.5 mm
load Fz	0.1 kN
Shell length	36 mm
statical load core	0.27 N/mm ²