

■ Insulated pipe clamp Husky IV 19 168.3 mm Insulation 25.9 M10/M12

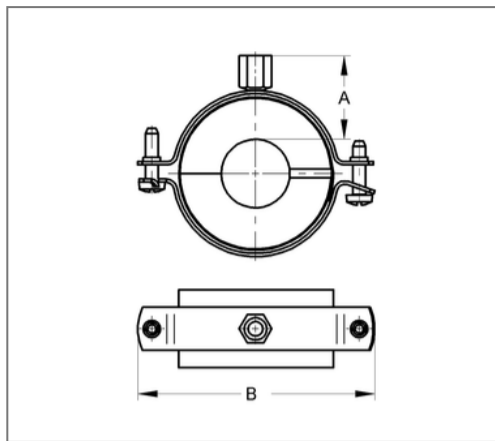

Commercial details

Part no.	6841680
EAN/GTIN	4250928440921
Packing unit	2 pcs
Price unit	1
Quantity unit	pcs
Weight	1,15 kg/pc
Product group	06-684

QR code



Certification



Specification

Application area	A thermal decoupled mounting of tubes guarantees a reliable prevention of condensate for refrigeration, air-conditioning and drinking water technologies in the sector pipe-clamping
Insulation body	KA/PU

Technical data

Material	Steel
Material type	S235
Material coat	Plastic
Surface	galvanized
Class	B2
min. temperature resistance	-45 °C
max. temperature resistance	105 °C
Thermal conductivity	0.029 W/mK
Density core	120 kg/m ³
Water vapour diffusion resistance	7000 μ

Product details

Connection	M10/M12
Connection height	51 mm
Width	297 mm
Insulation thickness	25.9 mm
load Fz	1.86 kN
Shell length	51 mm
statical load core	0.27 N/mm ²