

■ Pipe clamp Sigma 20x1 20 - 23 mm M8 EPDM

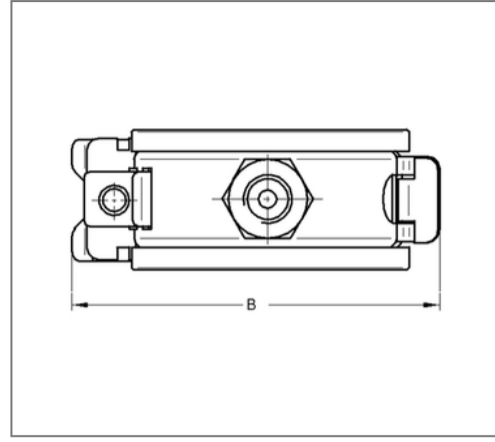
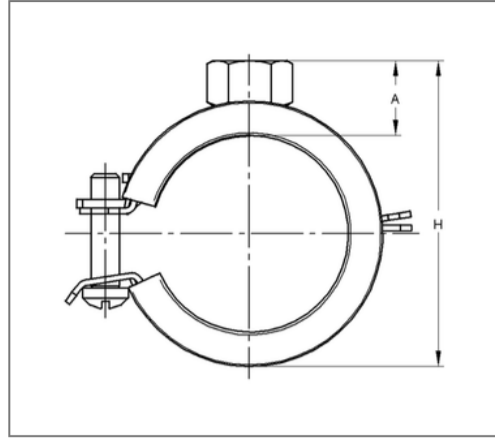

Commercial details

Part no.	14510231
EAN/GTIN	4250928432186
Packing unit	100 pcs
Price unit	100
Quantity unit	pcs
Weight	0,0330 kg/pc
Product group	01-045

QR code



Certification



Specification

Application area	Pipe clamp for fixing pipes.
Specification	one-part
Connection	M8
Closure	Sigma safety quick-closure

Technical data

Material	Steel
Material type	DC01-A, DD11
Surface	galvanized
Insulation thickness	3 mm
Temperature resistance	-35 °C - 100 °C
Sound insulation lining	Rubber EPDM

Product details

Connection height	12 mm
Width	51 mm
Colour sound insulation lining	black
Height	38 - 41 mm
Material dimension	20x1 mm
load Fz	0.45 kN
Clamping range	20 - 23 mm
Outside pipe diameter inch	1/2 inch
Closure screw	M5