

## ■ Pipe clamp Trabant 20x1 21 - 25 mm M8/M10 TPE

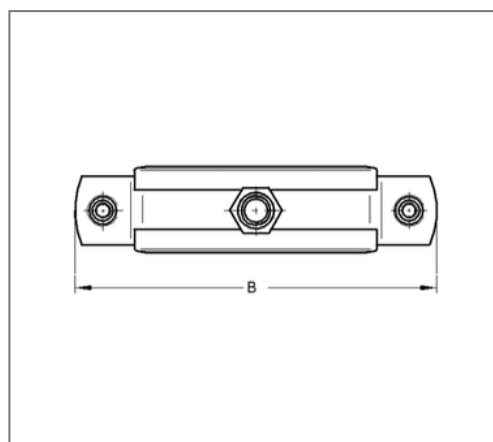
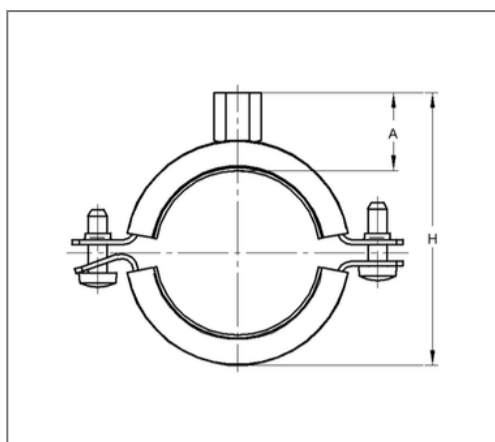

### Commercial details

Part no.	042625101
EAN/GTIN	4250928409195
Packing unit	100 pcs
Price unit	100
Quantity unit	pcs
Weight	0,0580 kg/pc
Product group	01-042

### QR code



### Certification



### Specification

Application area	Pipe clamp for fixing pipes.
Specification	two-part
Connection	M8/M10
Closure	Snap-in closure

### Technical data

Material	Steel
Material type	DD11
Surface	galvanized
Insulation thickness	4.5 mm
Temperature resistance	-35 °C - 100 °C
Sound insulation lining	Rubber TPE

### Product details

Connection height	22 mm
Width	69 mm
Colour sound insulation lining	black
Height	48 - 53 mm
Material dimension	20x1 mm
load Fz	0.29 kN
Clamping range	21 - 25 mm
Outside pipe diameter inch	1/2 inch
Closure screw	M6