

■ Pipe clamp Trabant 25x2,5 108 - 114 mm M8/M10 TPE

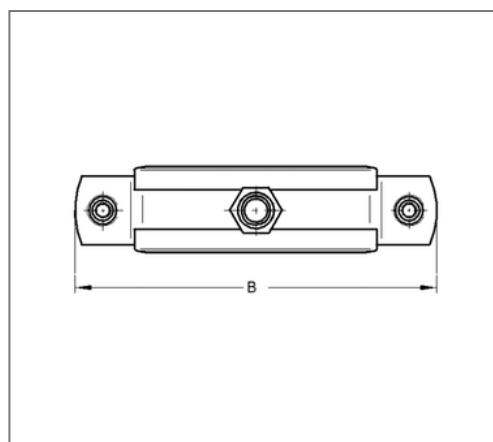
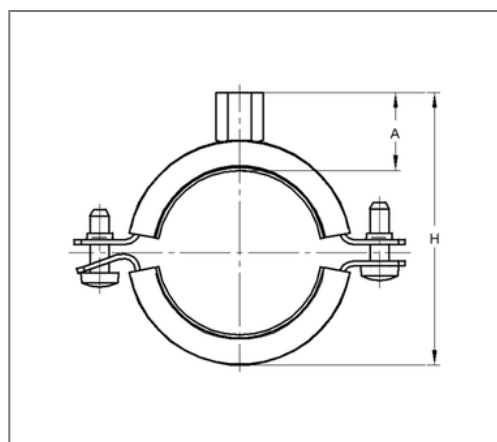

Commercial details

Part no.	0427141
EAN/GTIN	4250928409294
Packing unit	50 pcs
Price unit	100
Quantity unit	pcs
Weight	0,253 kg/pc
Product group	01-042

QR code



Certification



Specification

Application area	Pipe clamp for fixing pipes.
Specification	two-part
Connection	M8/M10
Closure	Snap-in closure

Technical data

Material	Steel
Material type	DD11
Surface	galvanized
Insulation thickness	4.5 mm
Temperature resistance	-35 °C - 100 °C
Sound insulation lining	Rubber TPE

Product details

Connection height	26 mm
Width	166 mm
Colour sound insulation lining	black
Height	142 - 148 mm
Material dimension	25x2.5 mm
load Fz	1.9 kN
Clamping range	108 - 114 mm
Outside pipe diameter inch	4 inch
Closure screw	M6