

■ Insulated pipe clamp Polar Plus 54 mm Insulation 20 M8/M10

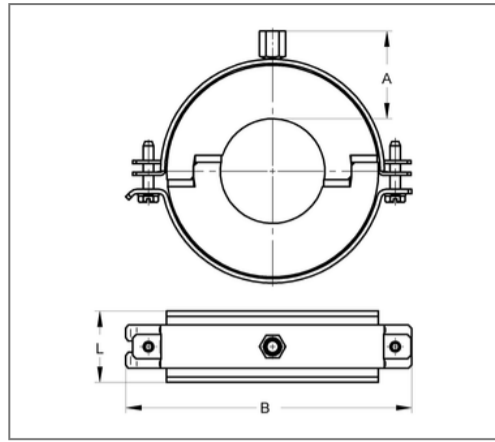
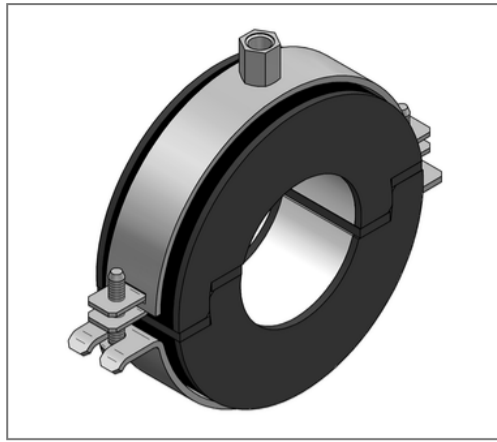

Commercial details

Part no.	74620540
EAN/GTIN	4250928442581
Packing unit	20 pcs
Price unit	1
Quantity unit	pcs
Weight	0,162 kg/pc
Product group	06-746

QR code



Certification



Specification

Application area	A thermal decoupled mounting of tubes guarantees a reliable prevention of condensate for refrigeration, air-conditioning and drinking water technologies in the sector pipe-clamping
Insulation body	AC/PU

Technical data

Material	Steel
Material type	DD11
Surface	galvanized
Class	B2
min. temperature resistance	-50 °C
max. temperature resistance	105 °C
Thermal conductivity	0.031 W/mK
Density core	145 kg/m ³
Water vapour diffusion resistance	7000 μ

Product details

Connection	M8/M10
Connection height	37 mm
Width	124 mm
Insulation thickness	20 mm
load Fz	0.52 kN
Shell length	36 mm
statical load core	0.38 N/mm ²