

## ■ Insulated pipe clamp Polar Plus 88.9 mm Insulation 20 M8/M10

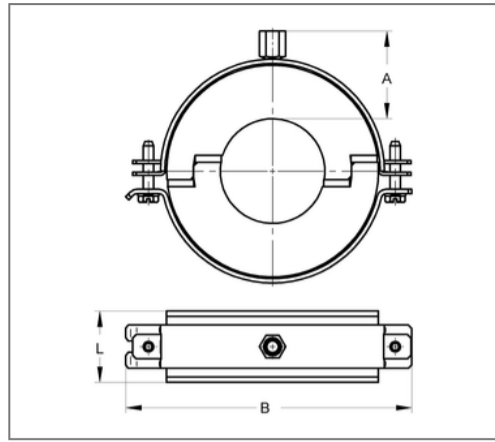
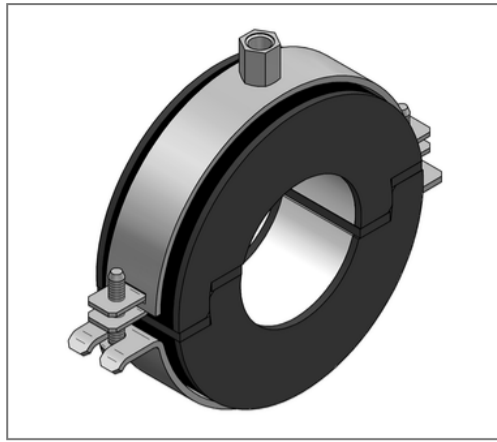

### Commercial details

Part no.	74620890
EAN/GTIN	4250928442642
Packing unit	15 pcs
Price unit	1
Quantity unit	pcs
Weight	0,295 kg/pc
Product group	06-746

### QR code



### Certification



### Specification

Application area	A thermal decoupled mounting of tubes guarantees a reliable prevention of condensate for refrigeration, air-conditioning and drinking water technologies in the sector pipe-clamping
Insulation body	AC/PU

### Technical data

Material	Steel
Material type	DD11
Surface	galvanized
Class	B2
min. temperature resistance	-50 °C
max. temperature resistance	105 °C
Thermal conductivity	0.031 W/mK
Density core	145 kg/m <sup>3</sup>
Water vapour diffusion resistance	7000 μ

### Product details

Connection	M8/M10
Connection height	39 mm
Width	165 mm
Insulation thickness	20 mm
load Fz	1.03 kN
Shell length	41 mm
statical load core	0.38 N/mm <sup>2</sup>