

## ■ Insulated pipe clamp Husky IV 19 88.9 mm Insulation 26.1 M10/M12

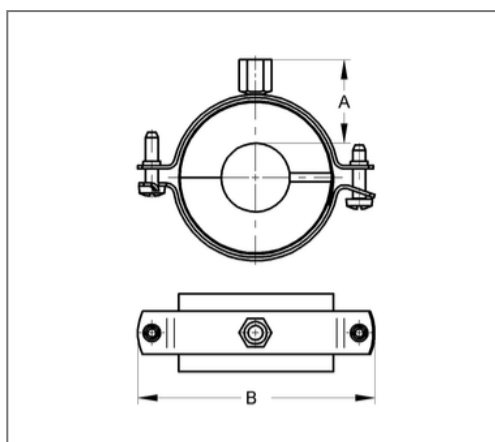

### Commercial details

Part no.	6840891
EAN/GTIN	4250928440853
Packing unit	8 pcs
Price unit	1
Quantity unit	pcs
Weight	0,365 kg/pc
Product group	06-684

### QR code



### Certification



### Specification

Application area	A thermal decoupled mounting of tubes guarantees a reliable prevention of condensate for refrigeration, air-conditioning and drinking water technologies in the sector pipe-clamping
Insulation body	KA/PU

### Technical data

Material	Steel
Material type	DD11
Material coat	Plastic
Surface	galvanized
Class	B2
min. temperature resistance	-45 °C
max. temperature resistance	105 °C
Thermal conductivity	0.029 W/mK
Density core	120 kg/m <sup>3</sup>
Water vapour diffusion resistance	7000 μ

### Product details

Connection	M10/M12
Connection height	43 mm
Width	187 mm
Insulation thickness	26.1 mm
load Fz	0.75 kN
Shell length	42 mm
statical load core	0.27 N/mm <sup>2</sup>