

■ Insulated pipe clamp Husky II 13 133 mm Insulation 17 M10/M12

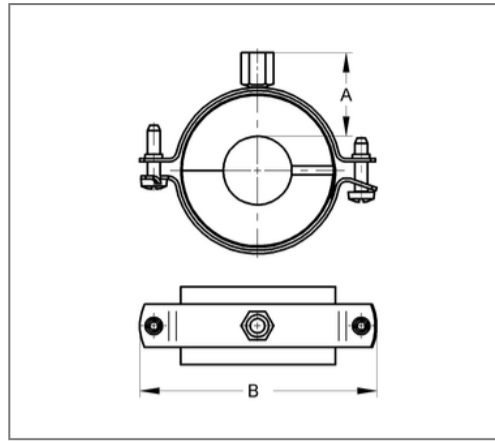

Commercial details

Part no.	6831331
EAN/GTIN	4250928440624
Packing unit	4 pcs
Price unit	1
Quantity unit	pcs
Weight	0,401 kg/pc
Product group	06-683

QR code



Certification



Specification

Application area	A thermal decoupled mounting of tubes guarantees a reliable prevention of condensate for refrigeration, air-conditioning and drinking water technologies in the sector pipe-clamping
Insulation body	KA/PU

Technical data

Material	Steel
Material type	DD11
Material coat	Plastic
Surface	galvanized
Class	B2
min. temperature resistance	-45 °C
max. temperature resistance	105 °C
Thermal conductivity	0.029 W/mK
Density core	120 kg/m ³
Water vapour diffusion resistance	7000 μ

Product details

Connection	M10/M12
Connection height	42 mm
Width	215 mm
Insulation thickness	17 mm
load Fz	1.13 kN
Shell length	42 mm
statical load core	0.27 N/mm ²

Remark

Note	delivery time on demand
------	-------------------------