

■ Pipe clamp Trabant 25x2,5 137 - 141 mm M10/M12 EPDM

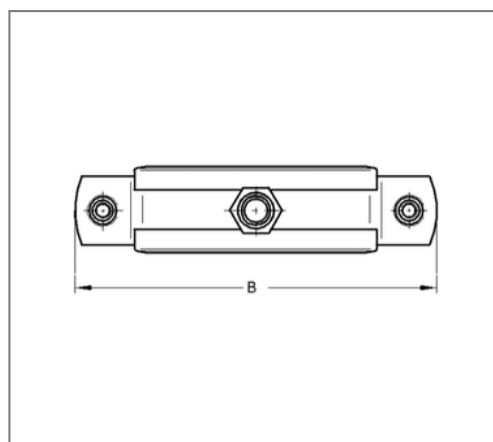
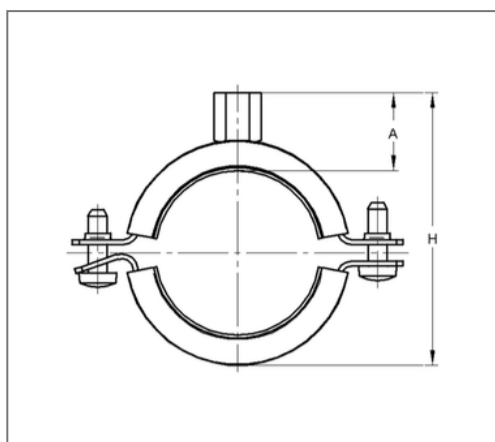

Commercial details

Part no.	04272411
EAN/GTIN	4250928409324
Packing unit	25 pcs
Price unit	100
Quantity unit	pcs
Weight	0,343 kg/pc
Product group	01-042

QR code



Certification



Specification

Application area	Pipe clamp for fixing pipes.
Specification	two-part
Connection	M10/M12
Closure	Snap-in closure

Technical data

Material	Steel
Material type	DD11
Surface	galvanized
Insulation thickness	4.5 mm
Temperature resistance	-35 °C - 100 °C
Sound insulation lining	Rubber EPDM

Product details

Connection height	27 mm
Width	192 mm
Colour sound insulation lining	black
Height	172 - 178 mm
Material dimension	25x2.5 mm
load Fz	2.2 kN
Clamping range	137 - 141 mm
Outside pipe diameter inch	5 inch
Closure screw	M6

Remark

Note	not certified acc. to RAL GZ-656
------	----------------------------------