

■ Pipe clamp Maxima PSM 35x4 133 - 136 mm M10/M12 TPE

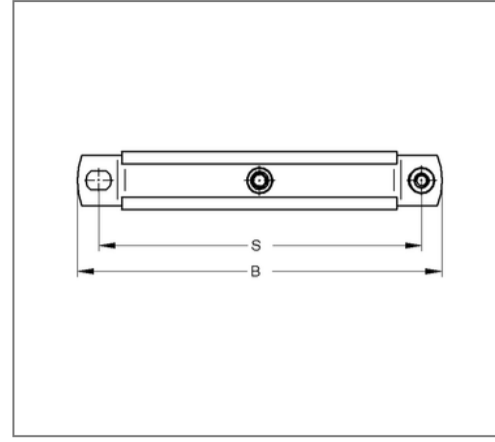
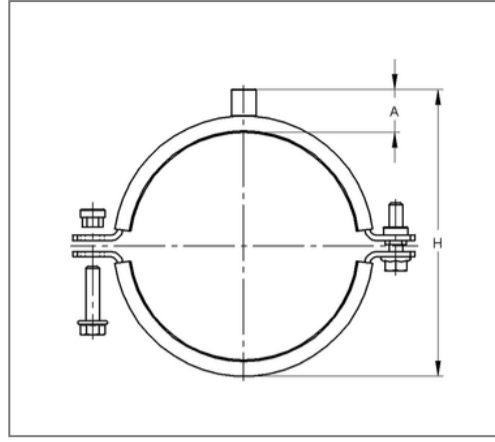
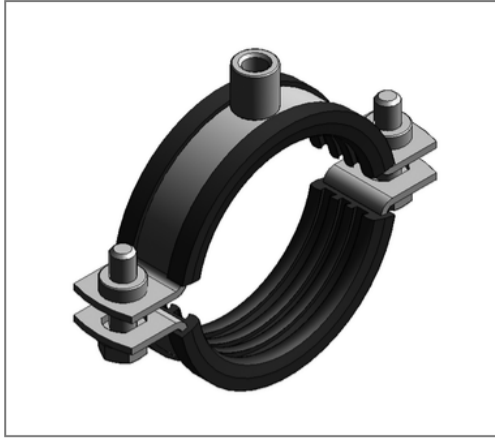

Commercial details

Part no.	0088136
EAN/GTIN	4250928407337
Packing unit	1 pcs
Price unit	100
Quantity unit	pcs
Weight	0,867 kg/pc
Product group	01-008

QR code



Certification



Specification

Application area	Pipe clamp for fixing pipes.
Specification	two-part
Connection	M10/M12
Closure	Pendulum stick nuts

Technical data

Material	Steel
Material type	S235
Surface	galvanized
Insulation thickness	6 mm
Temperature resistance	-35 °C - 100 °C
Sound insulation lining	Rubber TPE

Product details

Center distance	190 mm
Connection height	31 mm
Width	220 mm
Colour sound insulation lining	black
Height	174 - 177 mm
Material dimension	35x4 mm
load Fz	5 kN
Clamping range	133 - 136 mm
Closure screw	M10

Remark

Delivery time	5 working days ex works
Notice	With thread M16 or sleeve 1/2 Inch exchange and return are excluded.