

## ■ Pipe clamp Maxima PSM 35x4 270 - 275 mm M10/M12 TPE

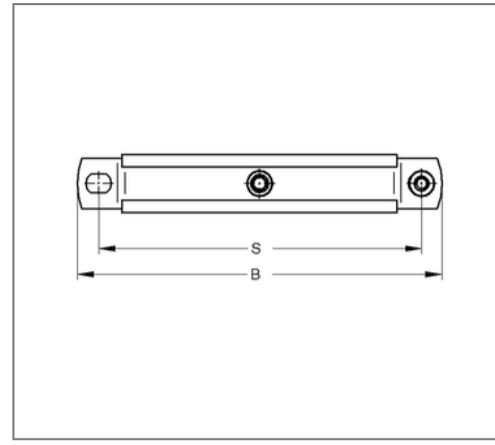
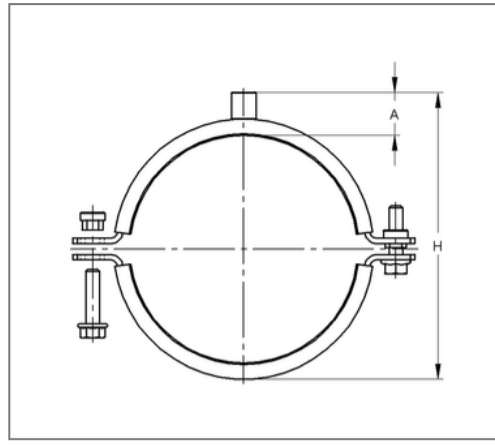
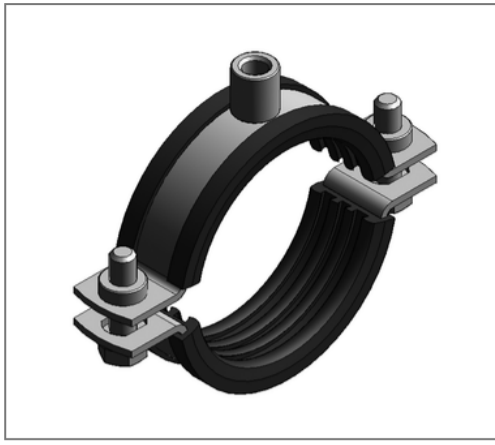

### Commercial details

Part no.	0080374
EAN/GTIN	4250928405982
Packing unit	1 pcs
Price unit	100
Quantity unit	pcs
Weight	1,48 kg/pc
Product group	01-008

### QR code



### Certification



### Specification

Application area	Pipe clamp for fixing pipes.
Specification	two-part
Connection	M10/M12
Closure	Pendulum stick nuts

### Technical data

Material	Steel
Material type	S235
Surface	galvanized
Insulation thickness	6 mm
Temperature resistance	-35 °C - 100 °C
Sound insulation lining	Rubber TPE

### Product details

Center distance	329 mm
Connection height	31 mm
Width	359 mm
Colour sound insulation lining	black
Height	311 - 316 mm
Material dimension	35x4 mm
load Fz	5 kN
Clamping range	270 - 275 mm
Outside pipe diameter inch	10 inch
Closure screw	M10

### Remark

Delivery time	5 working days ex works
Notice	With thread M16 or sleeve 1/2 Inch exchange and return are excluded.