

■ Sliding support T h=104 35 x 4 mm 60 mm unlined hot-dip galv.

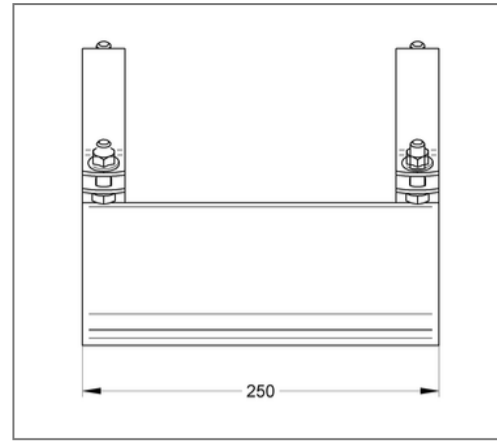
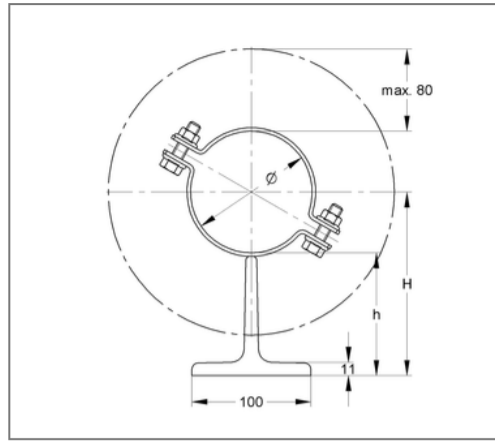
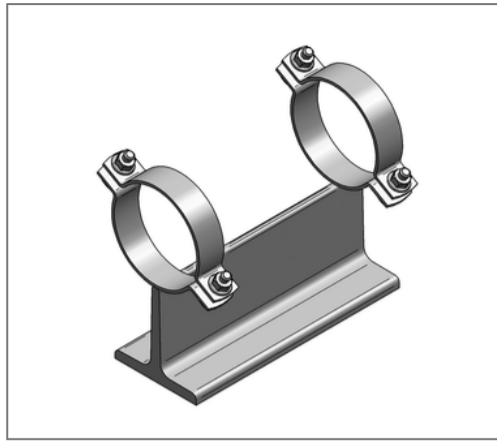

Commercial details

Part no.	145fa0060
EAN/GTIN	4250928459893
Packing unit	1 pcs
Quantity unit	pcs
Weight	5,36 kg/pc
Product group	14-148
Price unit	1

QR code



Specification

Specification	T-support
Closure screw	M10

Technical data

Material	Steel
Material type	S235
Surface	hot-dip galvanized
Sound insulation lining	unlined
Safety factor	1.54

Product details

Outer pipe diameter	60 mm
Material dimension pipe clamp	35x4 mm
Width substructure	100 mm
Height base	104 mm
Length of substructure	250 mm
load Fx	4.82 kN
load Fy	8 kN
load Fz hanging	6.84 kN
load Fz standing	13.67 kN