

■ Sliding support T h=105 50 x 5 mm 64 mm unlined hot-dip galv.

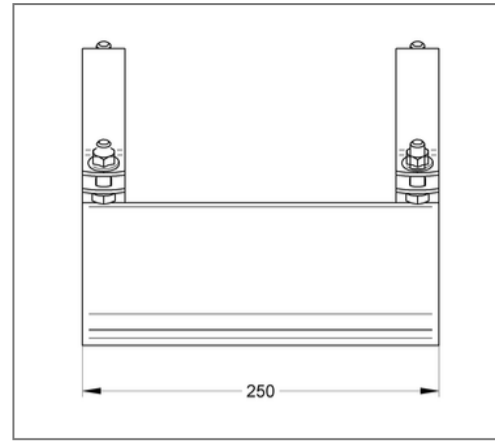
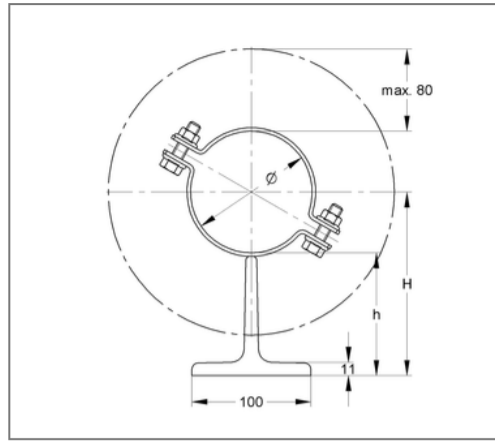
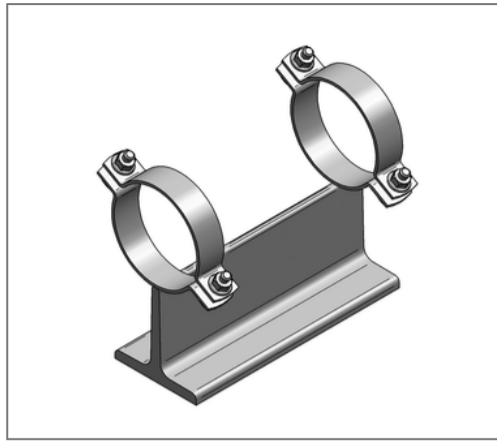

Commercial details

Part no.	145fa0064
EAN/GTIN	4250928459909
Packing unit	1 pcs
Quantity unit	pcs
Weight	6,13 kg/pc
Product group	14-148
Price unit	1

QR code



Specification

Specification	T-support
Closure screw	M12

Technical data

Material	Steel
Material type	S235
Surface	hot-dip galvanized
Sound insulation lining	unlined
Safety factor	1.54

Product details

Outer pipe diameter	64 mm
Material dimension pipe clamp	50x5 mm
Width substructure	100 mm
Height base	105 mm
Length of substructure	250 mm
load Fx	6.74 kN
load Fy	10 kN
load Fz hanging	9.77 kN
load Fz standing	19.53 kN