



Picomag

The smart plug-and-play flowmeter

Are you looking for space-saving flow and temperature measurement technology? Do you prefer to use cost-efficient devices in your plants? Do you need to follow specifications or regulatory requirements for process monitoring at numerous measuring points?

Yes? Then Picomag is the ideal device for your application:

- Robust compact design
- Secure commissioning and configuration via Bluetooth
- Cost-efficient operation without maintenance
- Efficient online ordering



[Picomag – An introduction](#)



Product overview

Picomag is available with various nominal diameters.
The compact size also makes it perfect for installation in skids.

Small

DN 15 to 25 (½ to 1")

[Click to navigate](#)

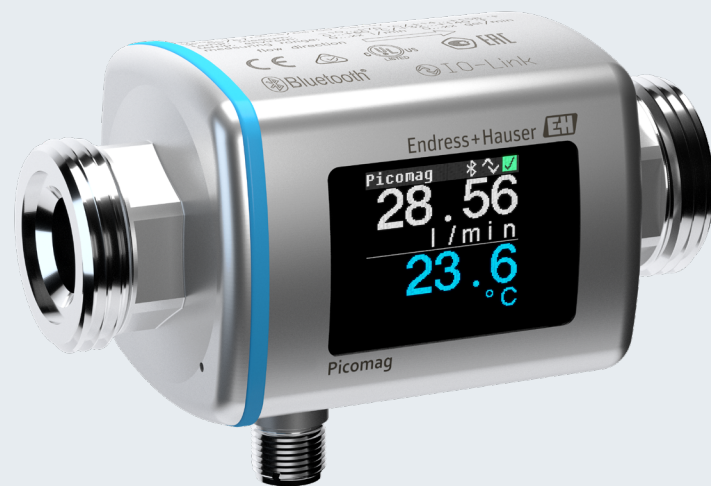

DN 15 (½")

Max. flow rate: 25 l/min (6.6 gal/min)
Installation length: 110 mm (4.33 in)
Connection: External thread G½"

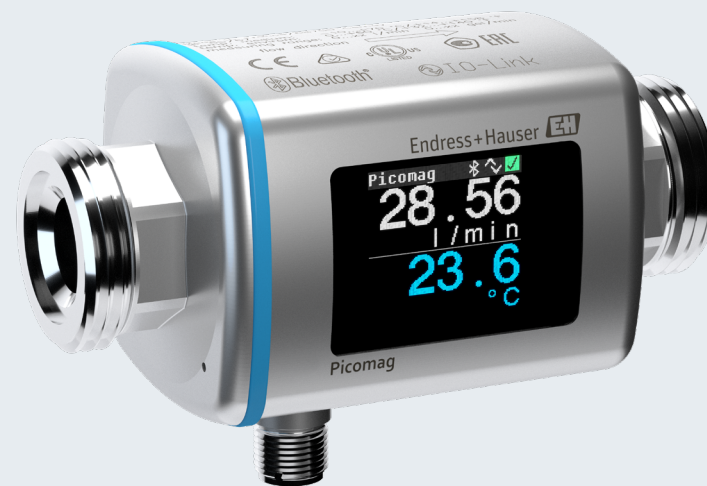

DN 20 (¾")

Max. flow rate: 50 l/min (13.2 gal/min)
Installation length: 110 mm (4.33 in)
Connection: External thread G¾"

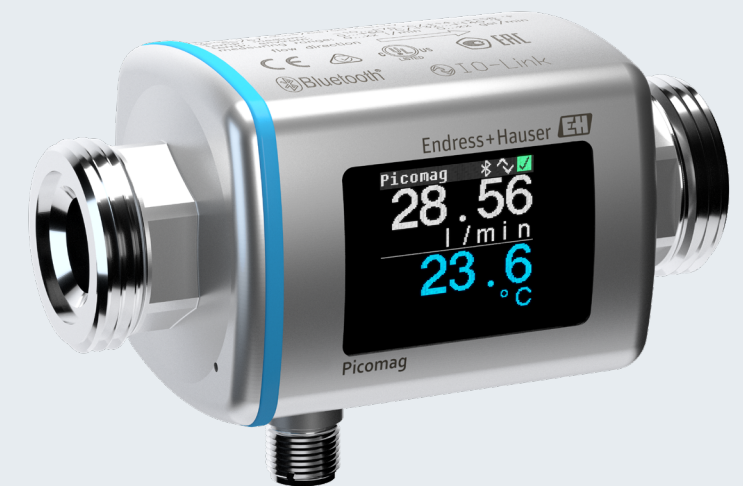

DN 25 (1")

Max. flow rate: 100 l/min (24.6 gal/min)
Installation length: 110 mm (4.33 in)
Connection: External thread G1"

Product overview

Picomag is available with various nominal diameters.
The compact size also makes it perfect for installation in skids.

Large
DN 50 (2")

Click to navigate



DN 50 (2")

Max. flow rate: 750 l/min (198 gal/min)

Installation length: 200 mm (7.87 in)

Connection: External thread G2"

Product overview

Picomag is available with various nominal diameters.
The compact size also makes it perfect for installation in skids.

Accessories

Click to navigate

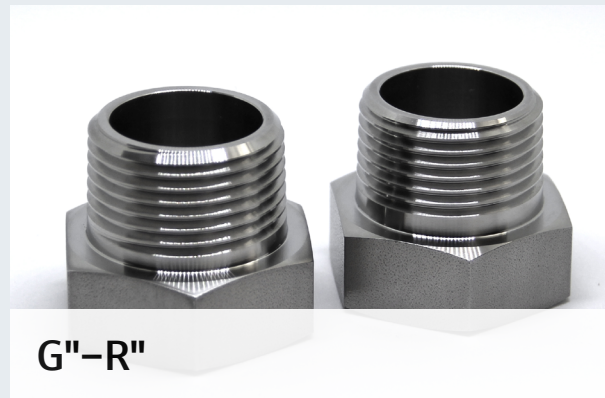

G"-R"



G"-G" internal thread



G"-Tri-clamp

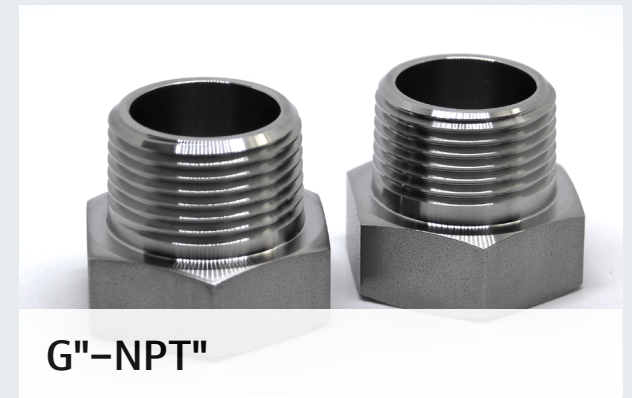

G"-NPT"

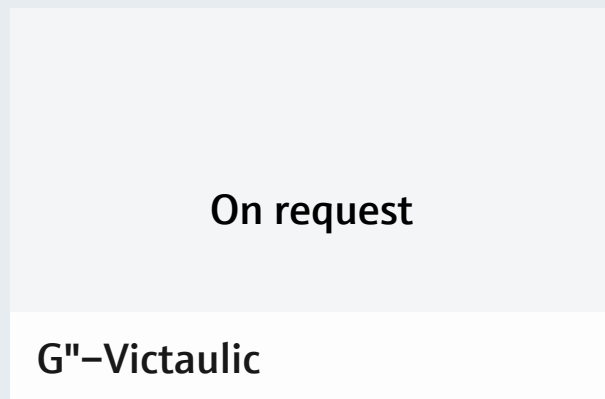

On request

G"-Victaulic

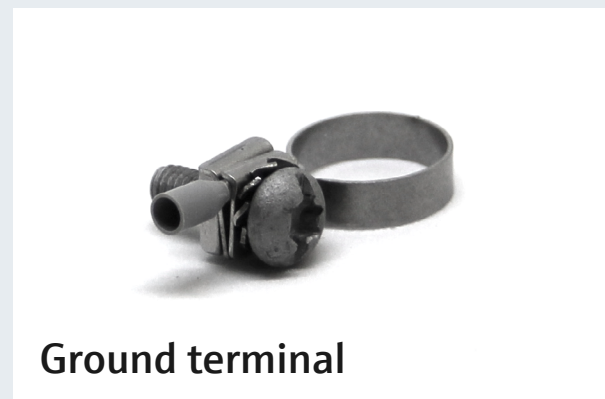

Ground terminal

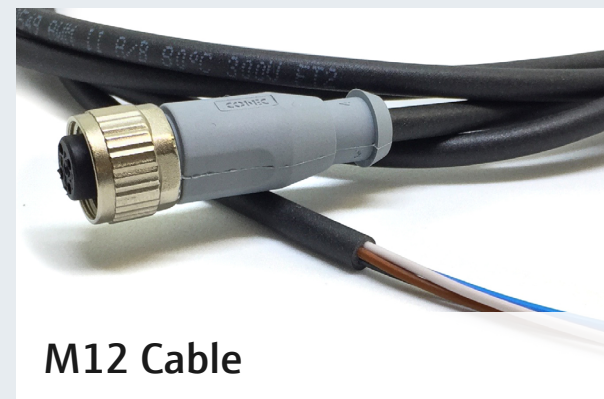

M12 Cable



Seal

Auto-rotatable display field

The display field rotates automatically depending on the installation position and flow direction. This means that the values are always easy to read.

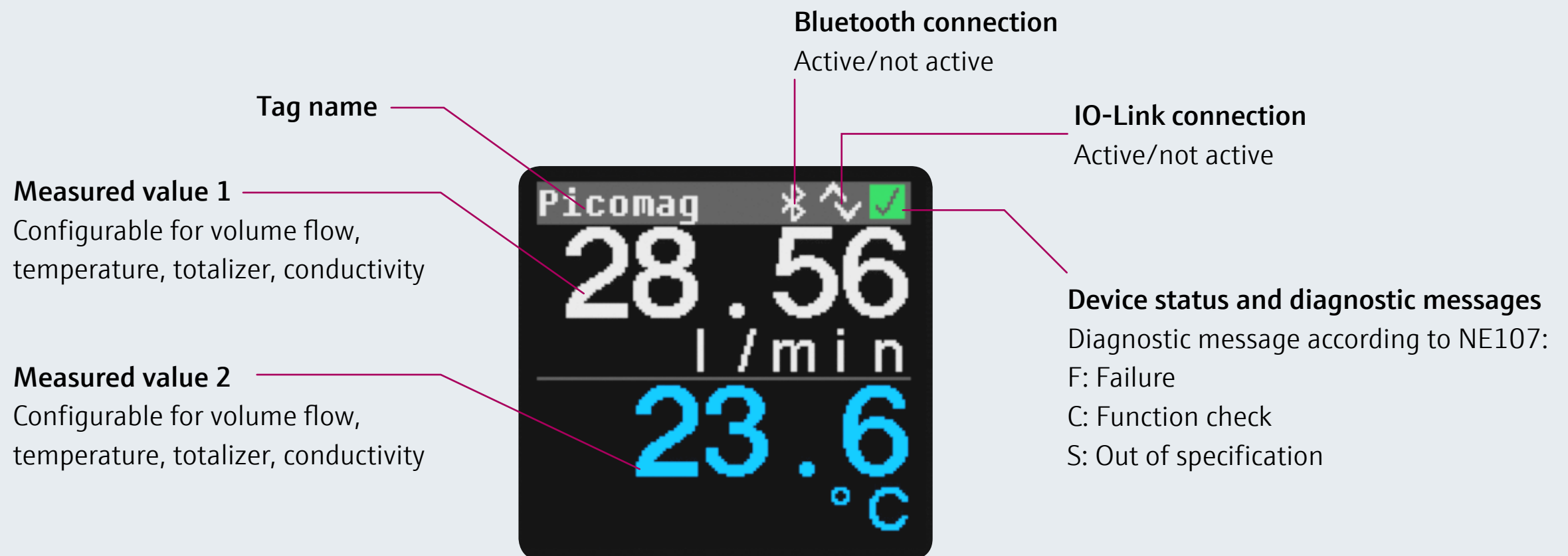

SmartBlue App

For commissioning in the field

The app allows for configuration as well as comprehensive access to device data. The connection is established via Bluetooth.

- Simple and fast navigation through device and diagnostic functions
- Wireless configuration/data retrieval:
 - Configuration of display, outputs, flow direction, units, etc.
 - Requesting diagnostics messages, etc.
- Available for Android and iOS
- Range: up to 10 meters



[SmartBlue App \(iOS\)](#)



[SmartBlue App \(Android\)](#)



[How to](#)



IO-Link

For seamless integration into your plant

Thanks to the IO-Link connection, Picomag can be integrated seamlessly into any communication and process automation system:

- Compatible with all standard fieldbus systems
- Comprehensive data access via the control room
- Simple parameterization without additional tools
- Automatic configuration after device replacement
- Easy wiring
- Industry 4.0 ready



[How to](#)

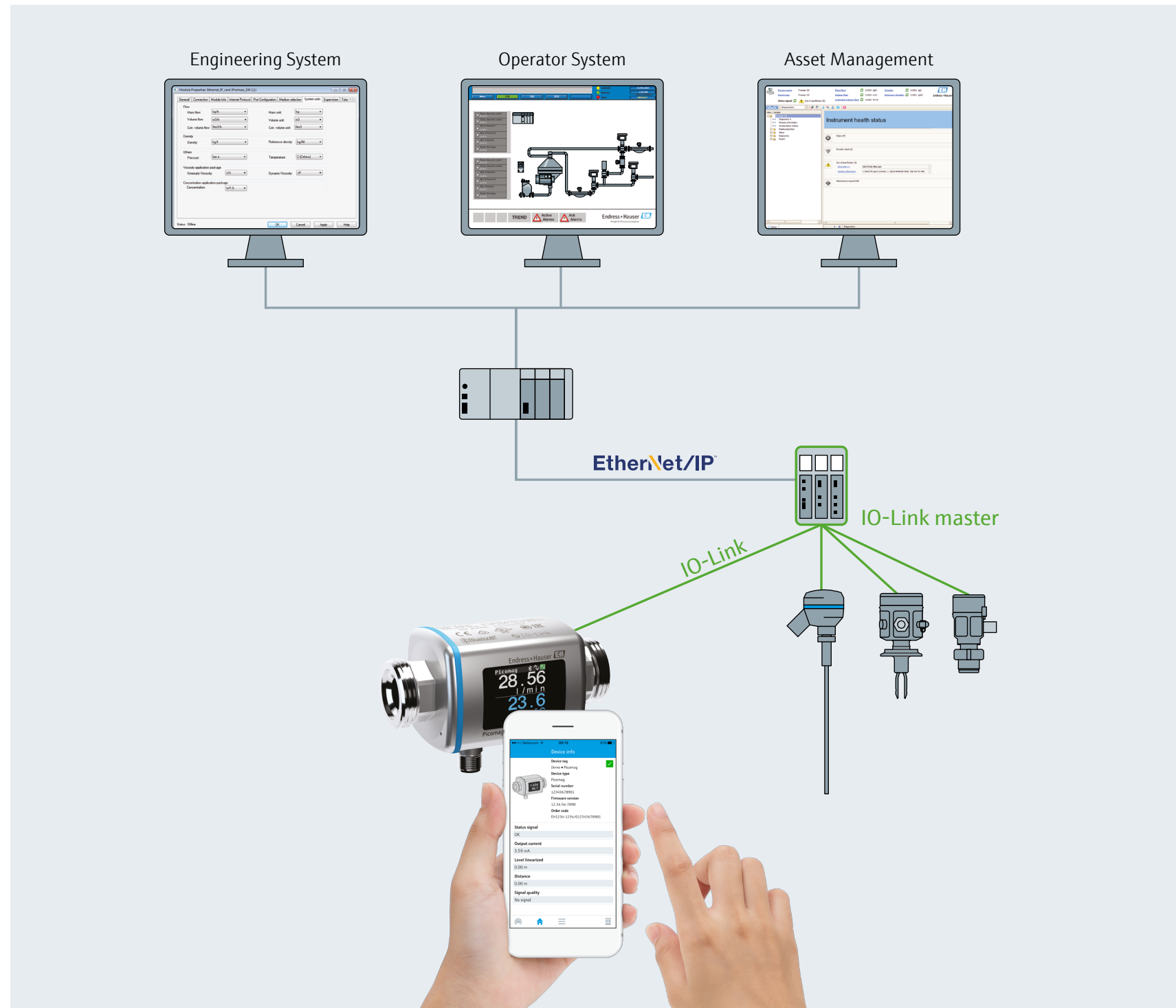

Adapter sets and cable connectors

For easy installation and electrical connection

Installation

Click to navigate

In addition to the standard thread connection, there are other adapter sets that can be used to install Picomag in pipes with a wide variety of process connections.

- 1 Pipe
- 2 Seal (not included in delivery)
- 3 Adapter ([available adapters](#))
- 4 Seal (included in delivery)
- 5 Measuring device connection

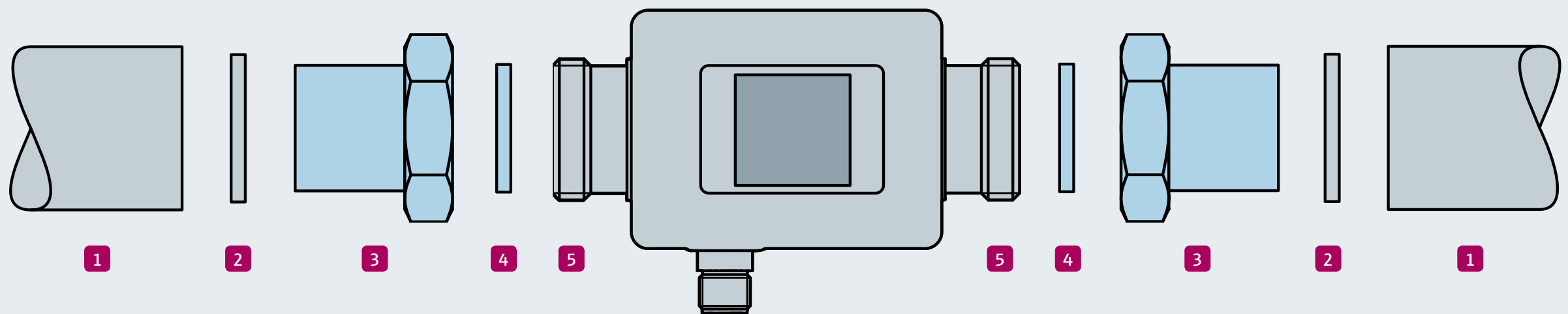

Adapter sets and cable connectors

For easy installation and electrical connection

Electrical connection
Signal outputs

Click to navigate

The cable connector (M12, A-coded) allows Picomag to be connected to your process control system quickly and easily.

A = Connection socket
B = Connection plug
1 = Supply voltage L+
(DC 19 to 30 V, max. 2 W)

2 = Output 2 (configurable)
3 = Supply voltage L-
4 = Output 1 (configurable)

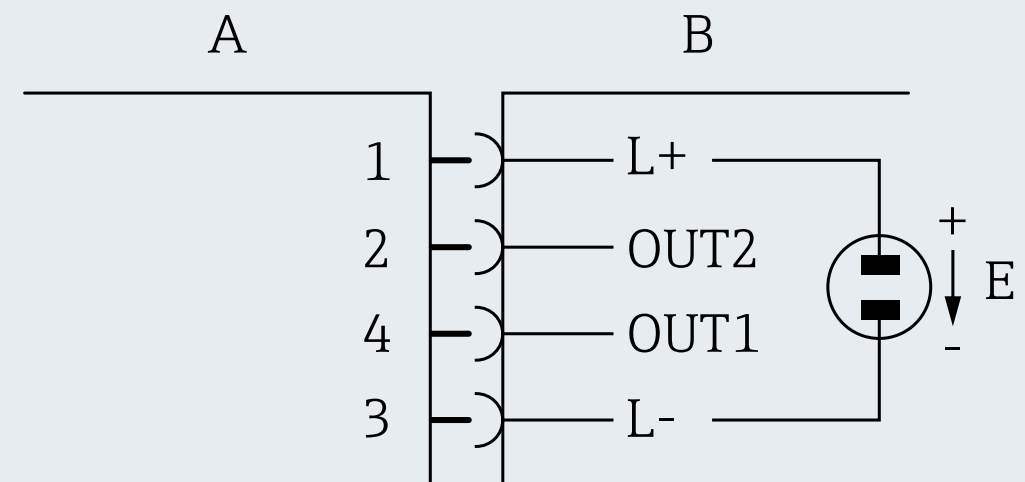
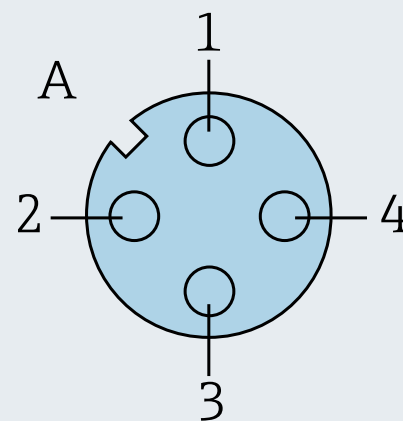
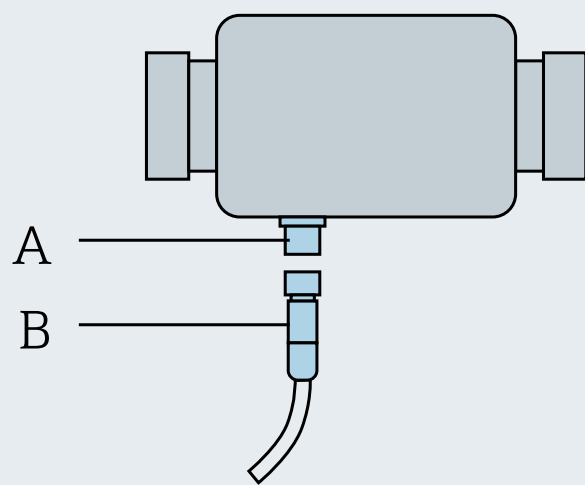

Application areas and examples

Picomag enables a reliable flow/temperature measurement of all conductive liquids

Example 1 – Metal industry

Measuring and monitoring cooling water
(industrial ovens)

[Click to navigate](#)



Application and measurement task

Various industrial ovens are cooled using a cooling circuit with water flowing through multiple cooling lines.

- Nominal diameters: DN 40 to 50 (1½ to 2")
- Nominal pressure: max. 20 bar (290 psi)
- Temperature of water discharge: 40 to 48 °C (104 to 118 °F)

Solution and advantages with Picomag

- Picomag can be used to monitor flow and water temperature simultaneously:
 - Flow → Monitoring
 - Temperature → Cooling performance monitoring
- Compact design → Cooling lines can be installed close together

Application areas and examples

Picomag enables a reliable flow/temperature measurement of all conductive liquids

Example 2 – Food industry
Monitoring cold/warm water
(process cooling/heating)

Click to navigate



Application and measurement task

A wide range of machines and systems for processing foodstuffs have a double jacket in which the cooling/heating water is measured.

Solution and advantages with Picomag

- Compact size → space-saving installation in the machine
- Simultaneous measurement of flow and temperature → Adherence to the optimal processing temperature

Application areas and examples

Picomag enables a reliable flow/temperature measurement of all conductive liquids

Example 3 – Beverage industry
Measuring and monitoring rinsing water
(cleaning containers)

Click to navigate



Application and measurement task

Applications for cleaning containers (bottles, crates, etc.) and tunnel pasteurization use water or leach solutions as rinsing water.

Solution and advantages with Picomag

The water supply and drainage are measured precisely in order to guarantee efficient use of water in the rinsing systems.

Technical data and dimensions

Technical data

Click to navigate

Measuring principle	Electromagnetic flow measurement	Nominal diameter	DN 15 (½"), DN 20 (¾"), DN 25 (1"), DN 50 (2")
Fluid	Suited for conductive liquids ($\geq 10 \mu\text{S/cm}$)	Measured variables	Volume flow, temperature, conductivity (temperature-compensated)
Display	1.4" TFT color display, auto-rotatable (dependent on orientation)	Process connections	Standard: external thread (G½", G¾", G1", G2") Optional: adapter sets for internal (G) and external (R, NPT) threads, Tri-clamp, Victaulic
Operation	<ul style="list-style-type: none"> SmartBlue App for smartphone or tablet IO-Link for operation via process control system 	Measuring range	<ul style="list-style-type: none"> DN 15: max. 25 l/min (6.6 gal/min) DN 20: max. 50 l/min (13.2 gal/min) DN 25: max. 100 l/min (26.4 gal/min) DN 50: max. 750 l/min (198.1 gal/min)
Material	Housing: 1.4404/316L, 1.4409/CF3M; Measuring tube: PEEK; Electrodes: 1.4435/316L; Process connection: 1.4404/316L; Display: polycarbonate; Seals: FKM	Inlet/outlet run	Not required (0 × DN)
Power supply	DC 18 to 30 V	Process pressure	16 bar (232 psi)
Process temperature	-10 to +70 °C (14 to +158 °F) temporarily up to +85 °C (+185 °F)	Max. measured error	Flow: $\pm 0.8\%$ o.r. $\pm 0.2\%$ o.f.s. Temperature: ± 2.5 °C (± 4.5 °F)
Degree of protection	IP65/67 (Type 4 enclosure)	Repeatability	Flow: $\pm 0.2\%$ o.f.s. Temperature: ± 0.5 °C (± 0.9 °F) Conductivity: $\pm 5\%$ o.r. $\pm 5 \mu\text{S/cm}$
In-/outputs (selectable)	2 freely selectable in-/outputs; current outputs (4–20 mA), pulse/switch output, voltage output (2 to 10 V), IO-Link, status inputs (e.g. for a totalizer reset)	Approvals	Drinking water approval (in prep.), UL listed (Underwriters Laboratories Inc.)
Communication	Via Bluetooth or IO-Link		

Subject to modification

The Picomag measuring system fulfills the EMC requirements according to IEC/EN 61326. It also conforms to the requirements of the EU and ACMA directives and thus carries the  and the  mark.

Technical data and dimensions

Dimensions
DN 15 to 25 (½ to 1")

Click to navigate

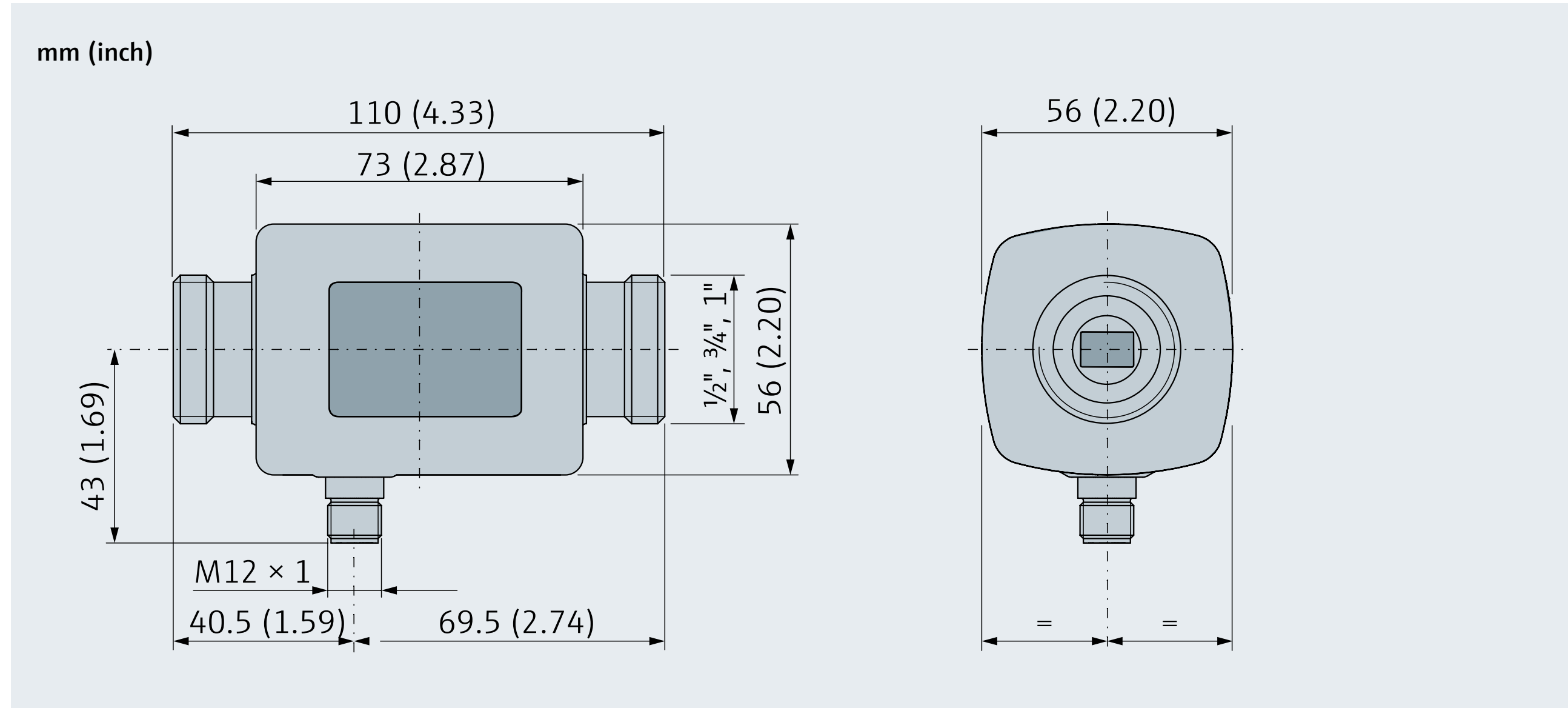

Technical data and dimensions

Dimensions DN 50 (2")

Click to navigate

