

### Cantilever Bracket AK

Group: 1354 / 2754

#### Application

Ready-to-use brackets mainly for mounting pipes to walls.  
For further options, e.g. double-versions see chapter "HCP Products"

#### Installation

When used in combination with slide elements, a Tie Rod is absolutely essential for absorbing the forces running along the centre line of the pipe.  
For cantilever lengths  $\geq 500$  mm we recommend the integration of a prop-up (see drawing below).

#### Technical Data

1 = Type 27/25  
2 = Type 27/37

Type 41/41

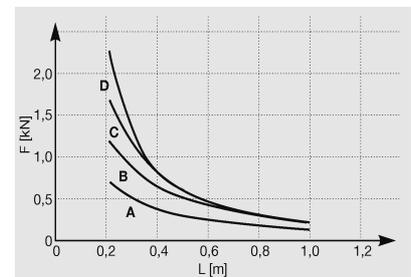
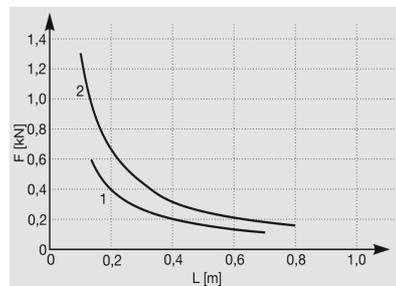
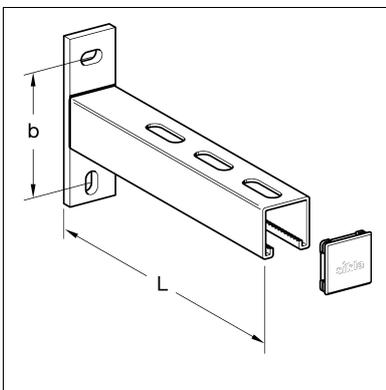

Type 41/62

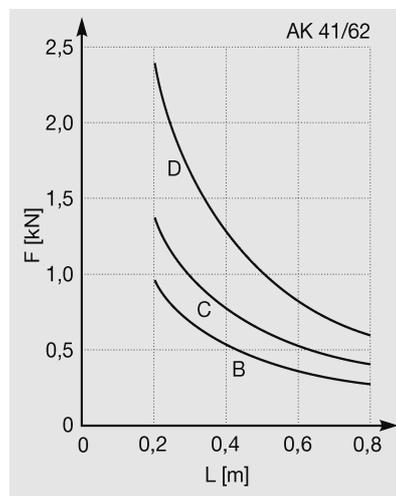
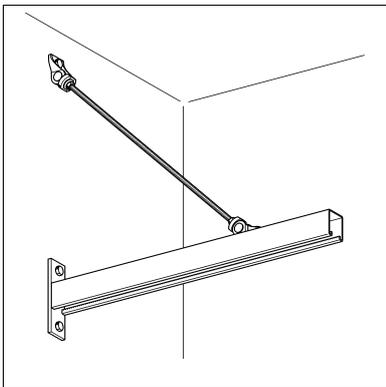

#### Anchor load classes

A = 1.5 kN  
B = 2.5 kN  
C = 3.5 kN  
D = 6.0 kN

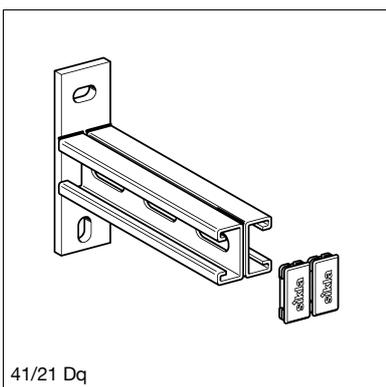
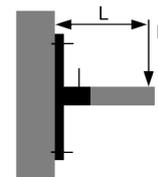

41/21 Dq

$\sigma_{\text{perm}} \leq 160 \text{ N/mm}^2$   
 $f_{\text{perm}} \leq L/150$  for  $L > 450$  mm  
 $f_{\text{perm}} \leq 3$  mm for  $L \leq 450$  mm

Material: Steel, electro-galvanised, Type Dq = HCP

Type	L [mm]	Wall plate [mm]	b [mm]	Dimensions of elongated hole [mm]	W [kg]	Quantity [pack]	Part number
27/25 - 200	203	88 x 30 x 6	64	10 x 15	0.25	25	<b>112326</b>
27/25 - 250	253	88 x 30 x 6	64	10 x 15	0.29	25	<b>112327</b>
27/25 - 300	303	88 x 30 x 6	64	10 x 15	0.34	25	<b>112328</b>
27/25 - 500	503	88 x 30 x 6	64	10 x 15	0.49	25	<b>112329</b>
27/25 - 700	703	88 x 30 x 6	64	10 x 15	0.65	1	<b>112330</b>
27/37 - 300	304	88 x 30 x 6	64	10 x 15	0.43	25	<b>111458</b>
27/37 - 500	504	88 x 30 x 6	64	10 x 15	0.64	25	<b>111459</b>
27/37 - 700	704	88 x 30 x 6	64	10 x 15	0.84	1	<b>111460</b>
27/37 - 800	804	88 x 30 x 6	64	10 x 15	0.96	1	<b>111461</b>
41/41 - 200	196	134 x 40 x 8	100	13 x 18	0.68	10	<b>115609</b>
41/41 - 260	258	134 x 40 x 8	100	13 x 18	0.81	10	<b>153973</b>
41/41 - 320	321	134 x 40 x 8	100	13 x 18	0.92	10	<b>115618</b>
41/41 - 445	446	134 x 40 x 8	100	13 x 18	1.16	10	<b>115627</b>
41/41 - 570	571	134 x 40 x 8	100	13 x 18	1.41	10	<b>115636</b>
41/41 - 820	821	134 x 40 x 8	100	13 x 18	1.89	1	<b>149268</b>
41/41 - 1010	1008	134 x 40 x 8	100	13 x 18	2.25	1	<b>149277</b>
41/62 - 320	321	134 x 40 x 8	100	13 x 18	1.42	10	<b>113296</b>
41/62 - 445	446	134 x 40 x 8	100	13 x 18	1.76	10	<b>113297</b>
41/62 - 570	571	134 x 40 x 8	100	13 x 18	2.25	10	<b>113298</b>
41/62 - 820	821	134 x 40 x 8	100	13 x 18	3.05	1	<b>113299</b>
41/62 - 1010	1008	134 x 40 x 8	100	13 x 18	3.59	1	<b>113300</b>
27/25 q - 300	303	88 x 30 x 5	64	10 x 15	0.34	25	<b>112366</b>
41/21 Dq - 320	321	134 x 40 x 8	100	13 x 18	1.20	10	<b>180164</b>
41/21 Dq - 570	571	134 x 40 x 8	100	13 x 18	1.95	10	<b>190424</b>