

GEBERIT FLOWFIT PRODUKTDATBLAD

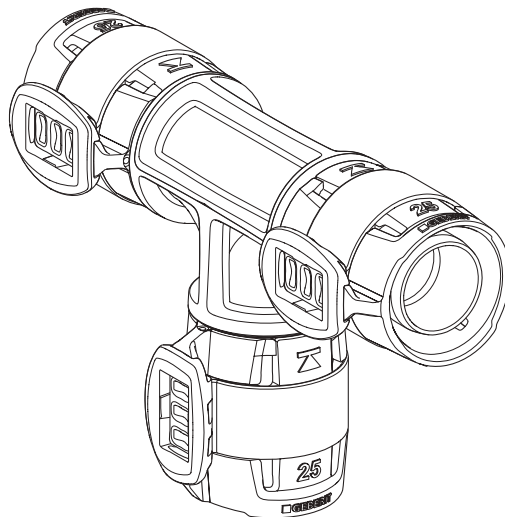

4 SORTIMENT

4.1 GEBERIT SYSTEMRÖR ML, RAKLÄNGD

Geberit systemrör ML, raklängd

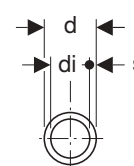
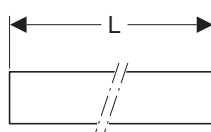
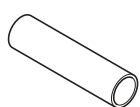

Artikelnr	RSK nr.	DN	d [mm]	di [mm]	s [mm]	L (m)
619.010.00.1	2005477	12	16	12	2	3
619.011.00.1	2005479	15	20	16	2	3
619.012.00.1	2005480	20	25	20	2,5	3
619.013.00.1	2005481	25	32	26,4	2,8	3
619.014.00.1	2005482	32	40	34	3	3
619.015.00.1	2005483	40	50	42,4	3,8	3
619.016.00.1	2005484	50	63	55	4	3
619.020.00.1	2005485	12	16	12	2	5
619.021.00.1	2005487	15	20	16	2	5
619.022.00.1	2005488	20	25	20	2,5	5
619.023.00.1	2005489	25	32	26,4	2,8	5
619.024.00.1	2005490	32	40	34	3	5
619.025.00.1	2005491	40	50	42,4	3,8	5
619.026.00.1	2005492	50	63	55	4	5
619.027.00.1	2005493	65	75	65,8	4,6	5

4.2 GEBERIT FLOWFIT KOPPLINGAR

Geberit FlowFit koppling

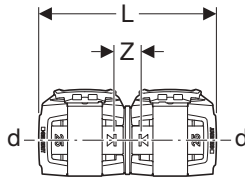
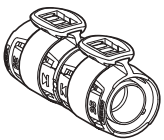

Artikelnr	RSK nr.	DN	d [mm]	L [cm]	Z [cm]
620.010.00.1	2252891	12	16	7,7	1,2
620.011.00.1	2252892	15	20	7,7	1,2
620.012.00.1	2252893	20	25	7,7	1,2
620.013.00.1	2252894	25	32	8,7	1,5
620.014.00.1	2252895	32	40	8,7	1,5
620.015.00.1	2252896	40	50	14,1	2,2
620.016.00.1	2252897	50	63	15,1	2,4
620.017.00.1	2252898	65	75	15,1	2,4

Geberit FlowFit lång koppling

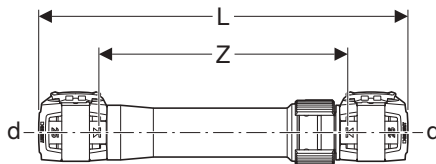
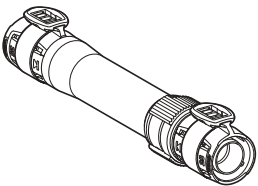

Artikelnr	RSK nr.	DN	d [mm]	L [cm]	Z [cm]
620.020.00.1	2252899	12	16	20	13,5
620.021.00.1	2252900	15	20	20	13,5
620.022.00.1	2252901	20	25	20	13,5
620.023.00.1	2252902	25	32	22,2	15
620.024.00.1	2252903	32	40	23,5	16,3
620.025.00.1	2252904	40	50	34	22

4.3 GEBERIT FLOWFIT REDUCERINGAR

Geberit FlowFit reducering

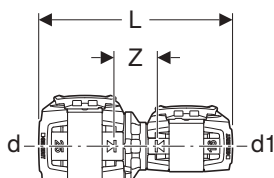
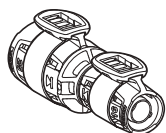

Artikelnr	RSK nr.	DN	d [mm]	d1 [mm]	L [cm]	Z [cm]
620.031.00.1	2252905	15/12	20	16	8,4	1,9
620.032.00.1	2252906	20/12	25	16	8,4	1,9
620.042.00.1	2252912	20/15	25	20	8,4	1,9
620.033.00.1	2252907	25/15	32	20	8,9	2
620.043.00.1	2252913	25/20	32	25	8,9	2
620.034.00.1	2252908	32/15	40	20	9,2	2,3
620.044.00.1	2252914	32/20	40	25	8,9	2
620.054.00.1	2252918	32/25	40	32	9,4	2,1
620.035.00.1	2252909	40/25	50	32	12,2	2,7
620.045.00.1	2252915	40/32	50	40	12,2	2,7
620.036.00.1	2252910	50/32	63	40	12,9	3
620.046.00.1	2252916	50/40	63	50	15,7	3,4
620.037.00.1	2252911	65/32	75	40	13,6	3,7
620.047.00.1	2252917	65/40	75	50	15,7	3,4
620.057.00.1	2252919	65/50	75	63	16,2	3,5

4.4 GEBERIT FLOWFIT BÖJAR

Geberit FlowFit böj

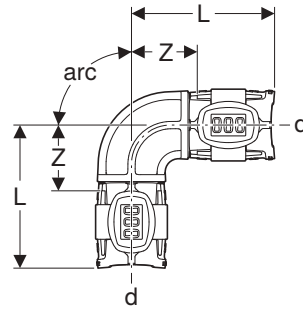
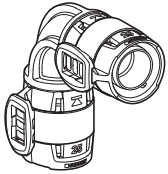

Artikelnr	RSK nr.	DN	d [mm]	L [cm]	Z [cm]
620.062.00.1	2253699	20	25	5,2	1,9
620.063.00.1	2253700	25	32	5,9	2,3
620.064.00.1	2253701	32	40	5,9	2,5
620.065.00.1	2253702	40	50	9	3
620.066.00.1	2253703	50	63	9,9	3,5
620.067.00.1	2253704	65	75	9,9	3,5
620.070.00.1	2253705	12	16	5,8	2,5
620.071.00.1	2253706	15	20	6	2,7
620.072.00.1	2253707	20	25	6,2	3
620.073.00.1	2253708	25	32	7	3,4
620.074.00.1	2253709	32	40	7,5	3,9
620.075.00.1	2253710	40	50	11,5	5,6
620.076.00.1	2253711	50	63	12,5	6,1
620.077.00.1	2253712	65	75	13	6,7

4.5 GEBERIT FLOWFIT T-RÖR

Geberit FlowFit T-rör liksidigt

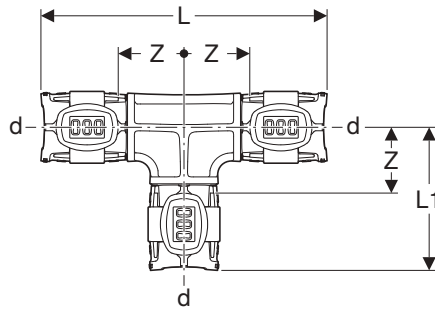
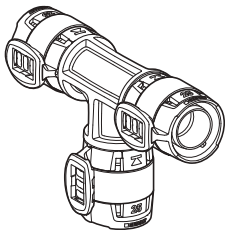

Artikelnr	RSK nr.	DN	d [mm]	L [cm]	L1 [cm]	Z [cm]
620.080.00.1	2254515	12	16	11,5	5,8	2,5
620.081.00.1	2254516	15	20	11,9	6	2,7
620.082.00.1	2254517	20	25	12,4	6,2	2,9
620.083.00.1	2254518	25	32	14	7	3,4
620.084.00.1	2254519	32	40	15	7,5	3,9
620.085.00.1	2254520	40	50	23	11,5	5,6
620.086.00.1	2254521	50	63	24,9	12,5	6,1
620.087.00.1	2254522	65	75	26,1	13,1	6,7

Geberit FlowFit T-rör reducerat

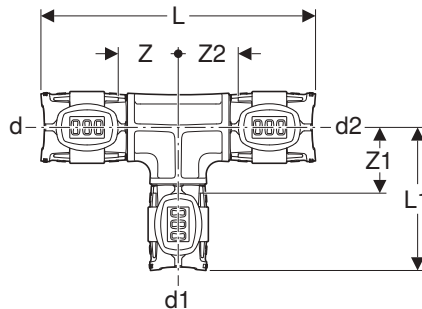
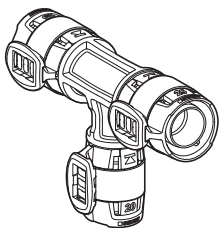

Artikelnr	RSK nr.	DN	d [mm]	d1 [mm]	d2 [mm]	L [cm]	L1 [cm]	Z [cm]	Z1 [cm]	Z2 [cm]
620.101.00.1	2254543	15 / 12 / 12	20	16	16	11,5	6	2,4	2,7	2,5
620.102.00.1	2254544	20 / 15 / 15	25	20	20	11,9	6,2	2,7	2,9	2,7
620.103.00.1	2254545	25 / 20 / 20	32	25	25	12,7	6,7	2,9	3,4	2,9
620.104.00.1	2254546	32 / 15 / 32	40	20	40	12,7	7,2	2,8	3,9	2,8
620.105.00.1	2254547	40 / 32 / 32	50	40	40	17,9	8,7	4	5	4,4
620.106.00.1	2254548	50 / 20 / 50	63	25	63	19,4	9	3,4	5,7	3,4
620.107.00.1	2254549	65 / 20 / 65	75	25	75	19,4	9,6	3,4	6,3	3,4
620.111.00.1	2254550	15 / 12 / 15	20	16	20	11,5	6	2,5	2,7	2,5
620.112.00.1	2254551	20 / 12 / 20	25	16	25	11,5	6,2	2,5	2,9	2,5
620.113.00.1	2254552	25 / 12 / 25	32	16	32	12	6,7	2,4	3,4	2,4
620.114.00.1	2254553	32 / 20 / 32	40	25	40	13,2	7,1	3	3,8	3
620.115.00.1	2254554	40 / 20 / 40	50	25	50	18,9	8,3	3,5	5	3,5

Artikelnr	RSK nr.	DN	d [mm]	d1 [mm]	d2 [mm]	L [cm]	L1 [cm]	Z [cm]	Z1 [cm]	Z2 [cm]
620.116.00.1	2254555	50 / 25 / 50	63	32	63	20,4	9,3	3,9	5,7	3,9
620.117.00.1	2254556	65 / 25 / 65	75	32	75	20,4	9,9	3,9	6,3	3,9
620.121.00.1	2254557	12 / 15 / 12	16	20	16	11,9	5,8	2,7	2,5	2,7
620.122.00.1	2254558	20 / 15 / 20	25	20	25	11,9	6,2	2,7	2,9	2,7
620.123.00.1	2254559	25 / 15 / 20	32	20	25	12,2	6,7	2,7	3,4	2,7
620.124.00.1	2254560	32 / 25 / 32	40	32	40	14,2	7,4	3,5	3,8	3,5
620.125.00.1	2254561	40 / 25 / 40	50	32	50	19,9	8,6	4	5	4
620.126.00.1	2254562	50 / 32 / 50	63	40	63	21,2	9,4	4,3	5,8	4,3
620.127.00.1	2254563	65 / 32 / 65	75	40	75	21,2	10	4,3	6,4	4,3
620.131.00.1	2254564	15 / 15 / 12	20	20	16	11,9	6	2,7	2,7	2,7
620.132.00.1	2254565	15 / 20 / 15	20	25	20	12,4	6	2,9	2,7	2,9
620.133.00.1	2254566	25 / 15 / 25	32	20	32	12,5	6,7	2,7	3,4	2,7
620.135.00.1	2254567	40 / 32 / 40	50	40	50	20,7	8,7	4,4	5	4,4
620.136.00.1	2254568	50 / 40 / 50	63	50	63	23,5	12,2	5,4	6,3	5,4
620.137.00.1	2254569	65 / 40 / 65	75	50	75	23,5	12,8	5,4	6,9	5,4
620.142.00.1	2254570	20 / 20 / 15	25	25	20	12,4	6,2	2,9	2,9	2,9
620.143.00.1	2254571	25 / 20 / 25	32	25	32	13	6,7	2,9	3,4	2,9
620.147.00.1	2254572	65 / 50 / 65	75	63	75	24,9	13	6,1	6,7	6,1

2 / 2

Geberit FlowFit T-rör med invändig gänga

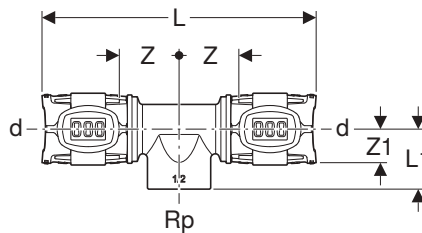
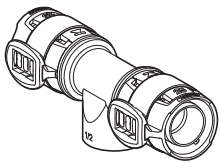

Artikelnr	RSK nr.	DN	d [mm]	Rp ["]	d1 [mm]	L [cm]	L1 [cm]	Z [cm]	Z1 [cm]
620.150.00.1	2254523	12 / 15 / 12	16	1/2	16	11,9	2,4	2,7	1,1
620.157.00.1	2254530	20 / 15 / 15	25	1/2	20	11,9	2,6	2,7	1,3
620.151.00.1	2254524	15	20	1/2	20	11,9	2,4	2,7	1,1
620.152.00.1	2254525	20 / 15 / 20	25	1/2	25	11,9	2,6	2,7	1,3
620.162.00.1	2254531	20	25	3/4	25	12,8	2,8	3,1	1,5
620.163.00.1	2254532	25 / 20 / 25	32	3/4	32	13,4	3,1	3,1	1,7
620.173.00.1	2254536	25	32	1	32	14,4	3,1	3,6	1,6
620.153.00.1	2254526	25 / 15 / 25	32	1/2	32	13	3,1	2,9	1,3
620.164.00.1	2254533	32 / 20 / 32	40	3/4	40	14,7	3,5	3,8	2,1
620.154.00.1	2254527	32 / 15 / 32	40	1/2	40	13,4	3,4	3,1	1,9
620.184.00.1	2254541	32	40	1 1/4	40	15,4	4,4	4,1	2,3
620.174.00.1	2254537	32 / 25 / 32	40	1	40	14,7	4,2	3,8	2,3
620.175.00.1	2254538	40 / 25 / 40	50	1	50	20,2	4,6	4,2	2,5
620.185.00.1	2254542	40	50	1 1/2	50	22	4,6	5,1	2,3
620.165.00.1	2254534	40 / 20 / 40	50	3/4	50	20,2	4	4,2	2,6
620.155.00.1	2254528	40 / 15 / 40	50	1/2	50	18,5	4,1	3,3	2,4
620.166.00.1	2254535	50 / 25 / 50	63	1	63	22	5,1	4,7	3,2
620.176.00.1	2254539	50	63	2	63	24,6	6,6	6	4
620.156.00.1	2254529	50 / 15 / 50	63	1/2	63	20,5	4,6	3,9	3,1
620.177.00.1	2254540	65 / 25 / 65	75	1	75	21,6	5,4	4,5	3,5

4.6 GEBERIT FLOWFIT ÖVERGÅNGAR EJ LÖSTAGBARA

Geberit FlowFit övergång till Geberit Mepla

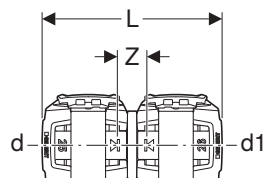
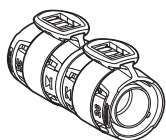

Artikelnr	RSK nr.	DN	d [mm]	d1 [mm]	L [cm]	Z [cm]
620.090.00.1	2257837	12	16	16	7,8	1,3
620.091.00.1	2257838	15	20	20	7,8	1,3
620.092.00.1	2257839	20	25	26	7,8	1,3
620.093.00.1	2257840	25	32	32	8,8	1,6
620.094.00.1	2257841	32	40	40	8,8	1,6
620.095.00.1	2257842	40	50	50	14	2,1
620.096.00.1	2257843	50	63	63	15	2,3
620.097.00.1	2257844	65	75	75	15	2,3

Geberit FlowFit övergång till Geberit Mapress, med slätända, rödgods

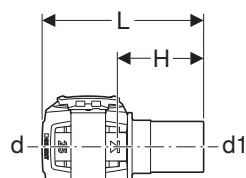
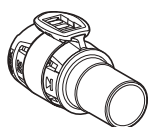

Artikelnr	RSK nr.	DN	d [mm]	d1 [mm]	L [cm]	H [cm]
620.230.00.1	2257819	12/10	16	12	6,8	3,5
620.240.00.1	2257826	12	16	15	6,9	3,6
620.231.00.1	2257820	15/12	20	15	6,9	3,6
620.241.00.1	2257827	15	20	18	6,9	3,6
620.242.00.1	2257828	15/20	20	22	7	3,7
620.232.00.1	2257821	20	25	22	7	3,7
620.233.00.1	2257822	25	32	28	7,7	4,1
620.234.00.1	2257823	32	40	35	8	4,4
620.235.00.1	2257824	40	50	42	12,8	6,9
620.236.00.1	2257825	50	63	54	13,8	7,5

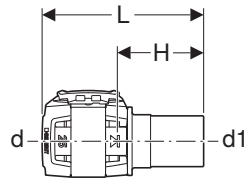
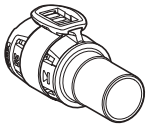
Geberit FlowFit övergång till Geberit Mapress, med slätända, rostfritt stål

Artikelnr	RSK nr.	DN	d [mm]	d1 [mm]	L [cm]	H [cm]
620.250.00.1	2257829	12	16	15	7,1	3,8
620.251.00.1	2257830	15	20	18	7,1	3,8
620.252.00.1	2257831	15/20	20	22	7,2	3,9
620.253.00.1	2257832	20	25	22	7,2	3,9
620.254.00.1	2257833	25	32	28	7,9	4,3
620.255.00.1	2257834	32	40	35	8,2	4,6
620.256.00.1	2257835	40	50	42	12,5	6,6
620.257.00.1	2257836	50	63	54	14,2	7,9

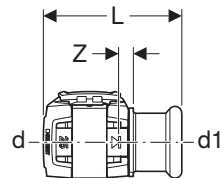
Geberit FlowFit övergång till Geberit Mapress, med pressmuff

Artikelnr	RSK nr.	DN	d [mm]	d1 [mm]	L [cm]	Z [cm]
620.329.00.1	2257810	12/10	16	12	5,4	0,6
620.332.00.1	2257811	12	16	15	5,6	0,6
620.333.00.1	2257812	15	20	18	5,6	0,6
620.334.00.1	2257813	15/20	20	22	5,7	0,6
620.335.00.1	2257814	20	25	22	5,7	0,6
620.336.00.1	2257815	25	32	28	6,4	0,8
620.337.00.1	2257816	32	40	35	6,7	0,8
620.338.00.1	2257817	40	50	42	9,7	1,1
620.339.00.1	2257818	50	63	54	10,7	1,2

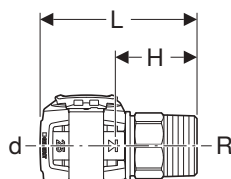
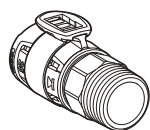
Geberit FlowFit övergång med utvändig gänga, kiselbrons

Artikelnr	RSK nr.	DN	d [mm]	R ["]	L [cm]	H [cm]	SW [mm]
620.300.00.1	2257789	12/10	16	3/8	6,1	2,8	18
620.310.00.1	2257797	12/15	16	1/2	6,1	2,8	22
620.320.00.1	2257804	12/20	16	3/4	6,5	3,2	27
620.301.00.1	2257790	15/10	20	3/8	6,1	2,8	18
620.311.00.1	2257798	15	20	1/2	6,4	3,1	22
620.321.00.1	2257805	15/20	20	3/4	6,5	3,2	27
620.302.00.1	2257791	20/15	25	1/2	6,4	3,1	22
620.312.00.1	2257799	20	25	3/4	6,8	3,5	27
620.322.00.1	2257806	20/25	25	1	6,6	3,3	34
620.303.00.1	2257792	25	32	1	7,5	3,9	34
620.313.00.1	2257800	25/32	32	1 1/4	7,2	3,6	43
620.304.00.1	2257793	32/25	40	1	7,4	3,8	47
620.314.00.1	2257801	32	40	1 1/4	7,4	3,8	47
620.324.00.1	2257807	32/40	40	1 1/2	7,3	3,7	49
620.305.00.1	2257794	40	50	1 1/2	10	4,1	59
620.315.00.1	2257802	40/50	50	2	10,4	4,4	60
620.306.00.1	2257795	50	63	2	11	4,7	74
620.316.00.1	2257803	50/65	63	2 1/2	11,3	4,9	76
620.307.00.1	2257796	65	75	2 1/2	11,4	5	86

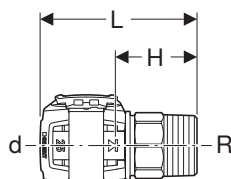
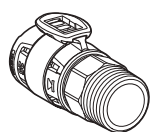
Geberit FlowFit övergång med utvändig gänga, rostfritt stål

Artikelnr	RSK nr.	DN	d [mm]	R ["]	L [cm]	H [cm]	SW [mm]
619.700.00.1	2257782	15	20	1/2	6,4	3,1	22
619.701.00.1	2257783	20	25	3/4	6,8	3,5	27
619.702.00.1	2257784	25	32	1	7,5	3,9	34
619.703.00.1	2257785	32	40	1 1/4	7,4	3,8	47
619.704.00.1	2257786	40	50	1 1/2	10	4,1	59
619.705.00.1	2257787	50	63	2	11	4,7	74
619.706.00.1	2257788	65	75	2 1/2	11,4	5	86

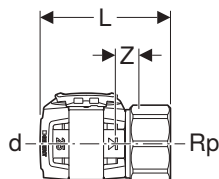
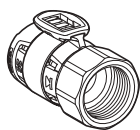
Geberit FlowFit övergång med invändig gänga

Artikelnr	RSK nr.	DN	d [mm]	Rp ["]	L [cm]	Z [cm]	SW [mm]
620.400.00.1	2257720	12/10	16	3/8	5,1	1	22
620.410.00.1	2257728	12/15	16	1/2	5,6	1,3	27
620.420.00.1	2257735	12/20	16	3/4	5,8	1,3	32
620.401.00.1	2257721	15/10	20	3/8	5,3	1,2	22
620.411.00.1	2257729	15	20	1/2	5,5	1,1	27
620.421.00.1	2257736	15/20	20	3/4	5,8	1,3	32
620.402.00.1	2257722	20	25	3/4	5,7	1,2	32
620.412.00.1	2257730	20/25	25	1	6,1	1,5	41
620.403.00.1	2257723	25	32	1	6,4	1,4	41
620.413.00.1	2257731	25/32	32	1 1/4	6,7	1,5	47
620.404.00.1	2257724	32/25	40	1	6,4	1,4	47
620.414.00.1	2257732	32	40	1 1/4	6,7	1,5	47
620.424.00.1	2257737	32/40	40	1 1/2	6,7	1,5	54
620.405.00.1	2257725	40	50	1 1/2	9,3	1,7	60
620.415.00.1	2257733	40/50	50	2	9,7	1,8	67
620.406.00.1	2257726	50	63	2	10,2	1,9	75
620.416.00.1	2257734	50/65	63	2 1/2	10,7	1,9	83
620.407.00.1	2257727	65	75	2 1/2	10,7	2,5	86

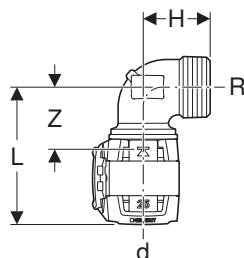
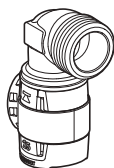
Geberit FlowFit böj 90° med utvändig gänga

Artikelnr	RSK nr.	DN	d [mm]	R ["]	L [cm]	H [cm]	Z [cm]
620.510.00.1	2253728	12/15	16	1/2	5,7	2,5	2,4
620.520.00.1	2253731	12/20	16	3/4	6	3,1	2,7
620.511.00.1	2253729	15	20	1/2	6,1	2,8	2,8
620.521.00.1	2253732	15/20	20	3/4	6	2,7	2,7
620.502.00.1	2253723	20	25	3/4	6	2,9	2,7
620.512.00.1	2253730	20/25	25	1	6,3	3,2	3
620.503.00.1	2253724	25	32	1	6,8	3,1	3,2
620.504.00.1	2253725	32	40	1 1/4	7,3	4,2	3,7
620.505.00.1	2253726	40	50	1 1/2	10,4	4,7	4,5
620.506.00.1	2253727	50	63	2	11,7	5,8	5,4

Geberit FlowFit böj 90° med utvändig gänga, lång

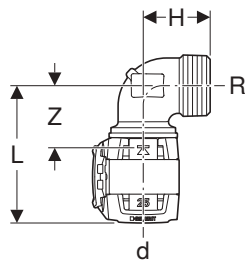
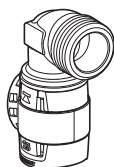

Artikelnr	RSK nr.	DN	d [mm]	R ["]	L [cm]	H [cm]	Z [cm]
620.522.00.1	2253733	12/15	16	1/2	5,7	3,7	2,4
620.523.00.1	2253734	12/20	16	3/4	6	4,5	2,7
620.524.00.1	2253735	15	20	1/2	6,1	3,7	2,8
620.525.00.1	2253736	15/20	20	3/4	6	4,5	2,7
620.526.00.1	2253737	20	25	3/4	6	4,5	2,7
620.527.00.1	2253738	20/25	25	1	6,3	5,6	3
620.528.00.1	2253739	25	32	1	6,8	5,6	3,2

Geberit FlowFit böj 90° med invändig gänga

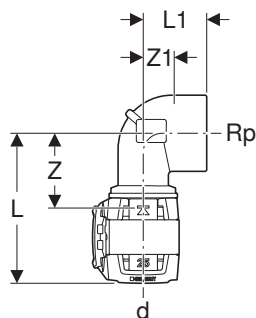
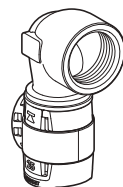

Artikelnr	RSK nr.	DN	d [mm]	Rp ["]	L [cm]	L1 [cm]	Z [cm]	Z1 [cm]
620.540.00.1	2253718	12/15	16	1/2	6,1	2,2	2,8	0,9
620.550.00.1	2253721	12/20	16	3/4	6,3	2,5	3	1,2
620.541.00.1	2253719	15	20	1/2	6,1	2,4	2,8	1,1
620.551.00.1	2253722	15/20	20	3/4	6,5	2,6	3,2	1,3
620.532.00.1	2253713	20	25	3/4	6,5	2,8	3,2	1,5
620.542.00.1	2253720	20/25	25	1	6,9	3	3,6	1,4
620.533.00.1	2253714	25	32	1	7,4	3,4	3,8	1,8
620.534.00.1	2253715	32	40	1 1/4	8,1	3,7	4,5	2,2
620.535.00.1	2253716	40	50	1 1/2	11,2	4,5	5,3	3
620.536.00.1	2253717	50	63	2	12,8	5,3	6,4	3,5

4.7 GEBERIT FLOWFIT ÖVERGÅNGAR OCH ANSLUTNINGAR, LÖSTAGBARA

Geberit FlowFit övergång med MasterFix

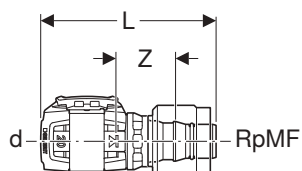
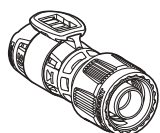

Artikelnr	RSK nr.	DN	d [mm]	RpMF ["]	L [cm]	Z [cm]
620.290.00.1	2257777	12/15	16	1/2	7,6	2,8
620.291.00.1	2257778	15	20	1/2	7,6	2,8

Geberit FlowFit övergångsvinkel 90° med MasterFix

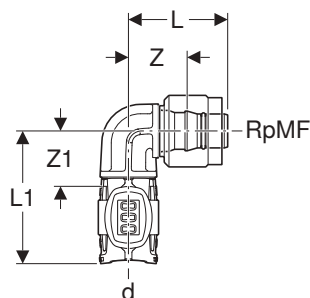

Artikelnr	RSK nr.	DN	d [mm]	RpMF ["]	L [cm]	L1 [cm]	Z [cm]	Z1 [cm]
620.490.00.1	2257848	12/15	16	1/2	4,3	5,8	2,7	2,5
620.491.00.1	2257849	15	20	1/2	4,3	5,8	2,8	2,5

Geberit FlowFit adapter-T-rör med MasterFix, genomgång

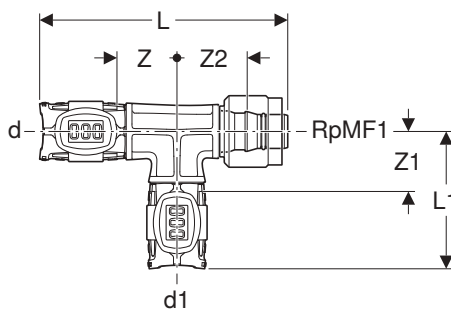
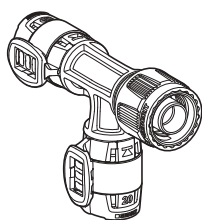

Artikelnr	RSK nr.	DN	d [mm]	d1 [mm]	RpMF1 ["]	L [cm]	L1 [cm]	Z [cm]	Z1 [cm]	Z2 [cm]
620.380.00.1	2257669	12 / 15 / 12	16	16	1/2	11,5	4,3	2,5	2,7	2,5
620.381.00.1	2257670	15 / 15 / 12	20	16	1/2	11,5	4,3	2,5	2,8	2,5
620.391.00.1	2257672	15	20	20	1/2	11,5	4,3	2,5	2,8	2,5
620.382.00.1	2257671	20 / 15 / 15	25	20	1/2	11,5	4,1	2,5	2,6	2,5
620.392.00.1	2257673	20 / 15 / 20	25	25	1/2	11,5	4,1	2,5	2,6	2,5

Geberit FlowFit adapter-T-rör med MasterFix, grenrör

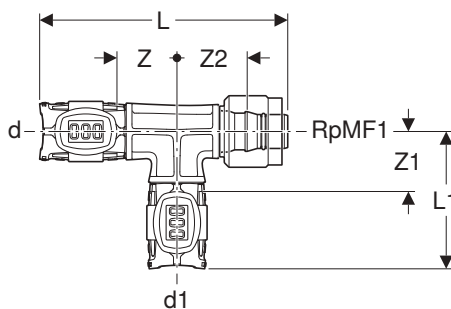
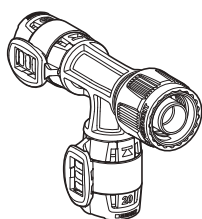

Artikelnr	RSK nr.	DN	d [mm]	d1 [mm]	RpMF1 ["]	L [cm]	L1 [cm]	Z [cm]	Z1 [cm]	Z2 [cm]
620.780.00.1	2257674	12/12/15	16	16	1/2	10,4	5,8	2,5	2,5	3,1
620.781.00.1	2257675	15	20	20	1/2	10,8	6	2,7	2,7	3,3

Geberit FlowFit skruvkoppling

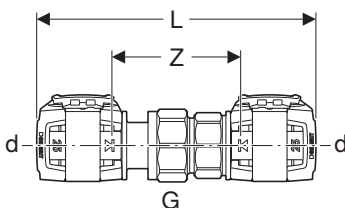
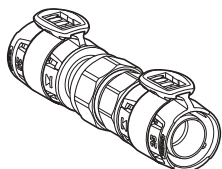

Artikelnr	RSK nr.	DN	d [mm]	G ["]	L [cm]	Z [cm]	SW [mm]
620.570.00.1	2257690	12	16	1/2	11,5	5	24
620.571.00.1	2257691	15	20	1/2	11,7	5,2	24
620.572.00.1	2257692	20	25	3/4	12,1	5,6	30
620.573.00.1	2257693	25	32	1	13,9	6,7	38
620.574.00.1	2257694	32	40	1 1/4	13,9	6,7	46
620.575.00.1	2257695	40	50	1 1/2	19,1	7,2	55
620.576.00.1	2257696	50	63	2	20,5	7,8	67

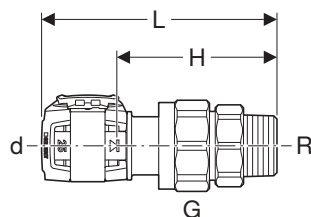
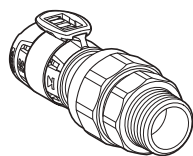
Geberit FlowFit unionskoppling med utvärdig gänga

Artikelnr	RSK nr.	DN	d [mm]	R ["]	G ["]	L [cm]	H [cm]	SW [mm]
620.580.00.1	2257707	12/15	16	1/2	3/4	8,7	5,4	30
620.581.00.1	2257708	15	20	1/2	3/4	9,3	6	30
620.591.00.1	2257714	15/20	20	3/4	1	9,4	6,1	30
620.582.00.1	2257709	20	25	3/4	1	10,2	6,9	38
620.583.00.1	2257710	25	32	1	1 1/4	10,5	6,9	46
620.593.00.1	2257715	25/32	32	1 1/4	1 1/2	10,8	7,2	46
620.584.00.1	2257711	32	40	1 1/4	1 1/2	11,3	7,7	55
620.594.00.1	2257716	32/40	40	1 1/2	1 3/4	11,3	7,7	55
620.585.00.1	2257712	40	50	1 1/2	1 3/4	14,9	9	62
620.595.00.1	2257717	40/50	50	2	2 3/4	14,9	8,9	67
620.586.00.1	2257713	50	63	2	2 3/4	15,3	8,9	89
620.596.00.1	2257718	50/65	63	2 1/2	2 3/4	15,5	9,2	89

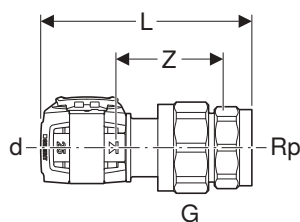
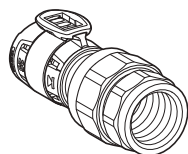
Geberit FlowFit unionskoppling med invändig gänga

Art.-nr	RSK nr.	DN	d [mm]	Rp ["]	G ["]	L [cm]	Z [cm]	SW [mm]
620.600.00.1	2257697	12/15	16	1/2	3/4	7,9	3,3	30
620.601.00.1	2257698	15	20	1/2	3/4	8,5	3,9	30
620.602.00.1	2257699	20	25	3/4	1	9,2	4,4	38
620.603.00.1	2257700	25	32	1	1 1/4	9,4	4,1	46
620.613.00.1	2257704	25/32	32	1 1/4	1 1/4	10,6	5,1	46
620.604.00.1	2257701	32	40	1 1/4	1 1/2	10,9	5,4	55
620.614.00.1	2257705	32	40	1 1/2	1 1/2	11,2	5,6	55
620.605.00.1	2257702	40	50	1 1/2	1 1/2	13,8	5,9	55
620.615.00.1	2257706	40/50	50	2	2	14,9	6,6	67
620.606.00.1	2257703	50	63	2	2 3/4	13,3	4,3	89

Geberit FlowFit övergång med löpande mutter

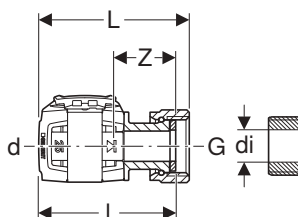
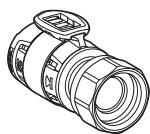

Artikelnr	RSK nr.	DN	d [mm]	di [mm]	G ["]	L [cm]	l [cm]	Z [cm]
620.620.00.1	2257741	12	16	9	3/8	6,2	5,5	2,2
620.630.00.1	2257748	12/15	16	11	1/2	6,4	5,7	2,4
620.640.00.1	2257755	12/20	16	17	3/4	5,9	5,2	1,9
620.650.00.1	2257762	12/25	16	21	1	6,2	5,4	2,1
620.621.00.1	2257742	15/12	20	9	3/8	6,2	5,5	2,2
620.631.00.1	2257749	15	20	11	1/2	6,4	5,7	2,4
620.641.00.1	2257756	15/20	20	16	3/4	6,5	5,8	2,5
620.651.00.1	2257763	15/25	20	21	1	6,3	5,5	2,2
620.661.00.1	2257769	15/32	20	27	1 1/4	6,6	5,6	2,3
620.671.00.1	2257773	15/40	20	32	1 1/2	6,2	5	1,7
620.622.00.1	2257743	20/15	25	11	1/2	6,4	5,7	2,4
620.632.00.1	2257750	20	25	15	3/4	6,5	5,8	2,5
620.642.00.1	2257757	20/25	25	20	1	7,3	6,3	3
620.652.00.1	2257764	20/32	25	27	1 1/4	6,8	5,8	2,5
620.662.00.1	2257770	20/40	25	32	1 1/2	7,1	5,9	2,6
620.672.00.1	2257774	15/30	20	23	1 1/8	6,4	5,5	2,2
620.623.00.1	2257744	25/20	32	16	3/4	7	6,3	2,7
620.633.00.1	2257751	25	32	20	1	7,8	6,8	3,2
620.643.00.1	2257758	25/32	32	27	1 1/4	7,4	6,4	2,8
620.653.00.1	2257765	25/40	32	32	1 1/2	7,6	6,4	2,8
620.663.00.1	2257771	25/50	32	42	2	7,5	6,2	2,6
620.673.00.1	2257775	20/50	25	42	2	6,3	5	1,7
620.624.00.1	2257745	32	40	27	1 1/4	7,9	6,9	3,3
620.634.00.1	2257752	32	40	33	1 1/2	8	6,9	3,3
620.644.00.1	2257759	32/50	40	42	2	7,8	6,5	2,9
620.654.00.1	2257766	32/65	40	42	2 1/4	7,7	6,3	2,7
620.625.00.1	2257746	40	50	33	1 1/2	10,6	9,5	3,6
620.635.00.1	2257753	40	50	33	1 3/4	11,5	10,2	4,3
620.645.00.1	2257760	40/50	50	42	2	11	9,9	3,9
620.655.00.1	2257767	40/50	50	42	2 1/4	10,8	9,4	3,5
620.665.00.1	2257772	40/50	50	52	2 3/8	10,9	9,4	3,5
620.675.00.1	2257776	40/65	50	62	2 3/4	10,7	9,1	3,2
620.626.00.1	2257747	50/50	63	42	2	11,5	10,4	4
620.636.00.1	2257754	50/50	63	52	2 3/8	11,6	10,5	4,1
620.646.00.1	2257761	50/65	63	54	2 1/2	11,8	10,2	3,9
620.656.00.1	2257768	50/65	63	62	2 3/4	11,5	9,9	3,6

Geberit FlowFit övergång med klämringskoppling

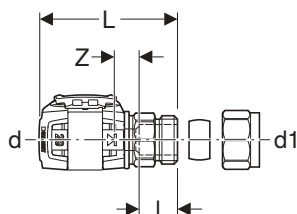
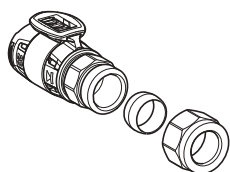

Artikelnr	RSK nr.	DN	d [mm]	d1 [mm]	L [cm]	l [cm]	Z [cm]
620.680.00.1	2257738	12/10	16	12	5,8	1,7	0,8
620.690.00.1	2257740	12	16	15	5,8	1,6	0,9
620.681.00.1	2257739	15/12	20	15	6	1,6	1,1

Geberit FlowFit övergångsvinkel 90° med klämringskoppling

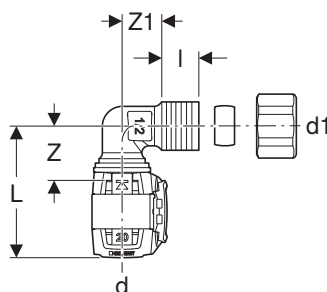

Artikelnr	RSK nr.	DN	d [mm]	d1 [mm]	L [cm]	l [cm]	Z [cm]	Z1 [cm]	SW [mm]
620.700.00.1	2257845	12/10	16	12	5,5	0,8	2,2	1,7	24
620.710.00.1	2257847	12	16	15	5,5	0,8	2,2	1,7	24
620.701.00.1	2257846	15/12	20	15	5,7	0,8	2,4	1,7	24

Geberit FlowFit övergång till klämringskoppling för kopparrör

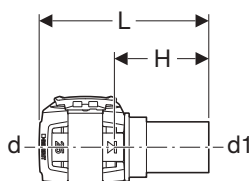
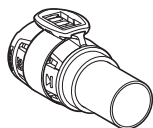

Artikelnr	RSK nr.	DN	d [mm]	d1 [mm]	L [cm]	H [cm]
620.720.00.1	2257719	12	16	15	7	3,7
620.721.00.1	2257808	15/12	20	15	7	3,7
620.722.00.1	2257809	20	25	22	7,4	4,1

Geberit FlowFit övergång med skruvkoppling till PEX-rör

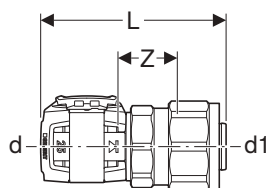
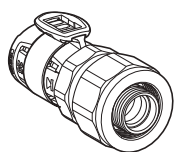

Artikelnr	RSK nr.	DN	d [mm]	G ["]	d1 [mm]	s1 [mm]	L [cm]	Z [cm]	PN [bar]
620.730.00.1	2257779	12	16	3/4	16	1,5	7,8	3,1	6
620.731.00.1	2257780	15	20	3/4	20	1,9	7,8	3,1	6
620.732.00.1	2257781	20	25	1	25	2,3	8	3,3	6

Geberit FlowFit fläns PN6, med pressenhet

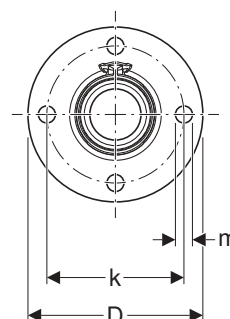
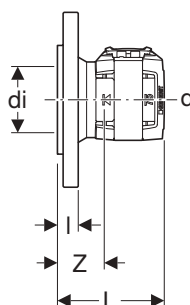
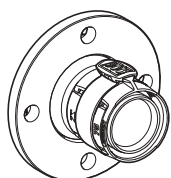

Artikelnr	RSK nr.	DN	d [mm]	di [mm]	D [cm]	k [cm]	m [cm]	L [cm]	l [cm]	Z [cm]	n [ST]	PN [bar]
619.616.00.1	2256041	65	75	70	16	130	14	11,3	2,4	5	4	6
619.617.00.1	2256040	65	75	70	18,5	145	18	11,3	2,4	5	4	10/16

4.8 GEBERIT FLOWFIT FÖRSLUTNINGAR

Geberit FlowFit rörändplugg

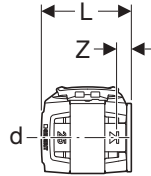

Artikelnr	RSK nr.	DN	d [mm]	L [cm]	Z [cm]
620.740.00.1	2256841	12	16	3,9	0,6
620.741.00.1	2256842	15	20	3,9	0,6
620.742.00.1	2256843	20	25	3,9	0,6

4.9 GEBERIT FLOWFIT ANSLUTNINGAR

Geberit FlowFit anslutningsvinkel 90°

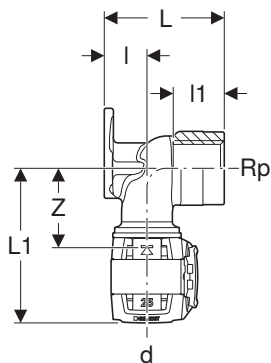
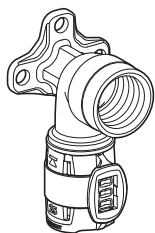

Artikelnr	RSK nr.	DN	d [mm]	Rp ["]	L [cm]	L1 [cm]	I [cm]	I1 [cm]	Z [cm]
620.750.00.1	2257678	12	16	3/8	3,6	6	1,9	1,3	2,7
620.751.00.1	2257679	15	20	3/8	3,6	6	1,9	1,3	2,7
620.760.00.1	2257680	12	16	1/2	3,6	6	1,9	1,3	2,8
620.761.00.1	2257681	15	20	1/2	3,6	6,3	1,9	1,3	3,1
620.810.00.1	2257687	12	16	1/2	5,2	6	1,9	1,5	2,7
620.811.00.1	2257688	15	20	1/2	5,2	6	1,9	1,7	3,1
620.821.00.1	2257689	15	20	3/4	5,2	6,3	1,9	1,9	3
620.802.00.1	2257686	20	25	3/4	5,2	6,7	1,9	1,9	3,4
620.770.00.1	2257682	12	16	1/2	7,8	6,8	1,9	3	3,5
620.771.00.1	2257683	15	20	1/2	7,8	7,3	1,9	3	4
620.800.00.1	2257684	12	16	3/8	5,2	6	1,9	1,5	2,7
620.801.00.1	2257685	15	20	3/8	5,2	6	1,9	1,5	2,7

4.10 GEBERIT FLOWFIT FÖRDELARE MED GÄNGAD ANSLUTNING

Geberit FlowFit anslutning för grenrör för Eurokona

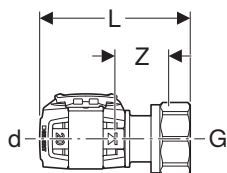

Artikelnr	RSK nr.	DN	d [mm]	G ["]	L [cm]	Z [cm]	SW [mm]
620.330.00.1	2257676	12/20	16	3/4	6,1	2,6	27
620.331.00.1	2257677	15/20	20	3/4	6,5	3,1	27

4.11 GEBERIT FLOWFIT FÄSTE FÖR SYSTEMRÖR

Geberit fixpunktmontering

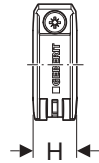
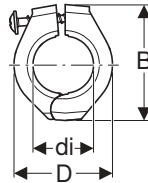
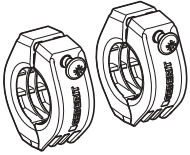

Artikelnr	RSK nr.	di [mm]	D [cm]	B [cm]	H [cm]
619.730.00.1	2054972	16	3,1	4	1,9
619.731.00.1	2054973	20	3,5	4,4	1,9
619.732.00.1	2054974	25	4	4,9	1,9
619.733.00.1	2054975	32	4,7	5,6	1,9
619.734.00.1	2054976	40	5,6	6,5	1,9
619.735.00.1	2054977	50	6,6	7,8	2,2
619.736.00.1	2054978	63	8	9,1	2,2
619.737.00.1	2054979	75	9,2	10,3	2,2

4.12 GEBERIT FLOWFIT TILLBEHÖR

Geberit läcksökningspray



Artikelnr	RSK nr.
690.942.00.1	2258438