

MAGNA3

Circulator pumps
50/60 Hz



1. Product description	3
Main applications	3
Type key	4
Performance range, MAGNA3	5
Performance range, MAGNA3 D single-head operation	6
Performance range, MAGNA3 D twin-head operation	6
2. Product range	7
Pump selection	8
3. Functions	9
System application	9
Functions	15
Operating modes	16
Control modes	16
Additional features for control modes	19
Additional operating modes for multi-pump setup	21
Readings and settings on the pump	21
Communication	24
4. Operating conditions	27
General recommendations	27
Pumped liquids	27
Differential-pressure and temperature sensor	28
Electrical data	29
5. Construction	30
Sectional drawing	31
Material specification	31
6. Installation	32
Mechanical installation	32
Electrical installation	32
Cables	32
Examples of connections	33
7. Accessories	36
Insulating kits for air-conditioning and cooling systems	36
CIM modules	36
Grundfos Remote Management	37
Grundfos GO Remote	38
Counter flanges	39
External sensors	45
Blanking flange	45
8. Curve conditions	46
Performance curves	46
QR code on pump nameplate	47
Markings	47
9. Performance curves and technical data	48
10. Product numbers	106
MAGNA3 for the international market	106
MAGNA3 for the German market	107
11. Further product information	108
WebCAPS	108
WinCAPS	109
GO CAPS	110

1. Product description

The Grundfos MAGNA3 circulator pumps are designed for circulating liquids in the following systems:

- heating systems
- air-conditioning and cooling systems
- domestic hot-water systems.

The pump range can also be used in the following systems:

- ground source heat pump systems
- solar-heating systems.

Duty range

Data	MAGNA3 (N) Single-head pumps	MAGNA3 D Twin-head pumps
Maximum flow rate, Q	78.5 m ³ /h	150 m ³ /h
Maximum head, H	18 metres	
Maximum system pressure	1.6 MPa (16 bar)	
Liquid temperature	-10 to +110 °C	



TM05 5751 3912

Fig. 1 MAGNA3 pump ranges

Characteristic features

- AUTO_{ADAPT}.
- FLOW_{ADAPT} and FLOW_{LIMIT}.
- Proportional-pressure control.
- Constant-pressure control.
- Constant-temperature control.
- Constant-curve duty.
- Max. or min. curve duty.
- Automatic Night Setback.
- No external motor protection required.
- Insulating shells supplied with single-head pumps for heating systems.
- Large temperature range where the liquid temperature and the ambient temperature are independent of each other.

Benefits

- Low energy consumption. All MAGNA3 pumps comply with the EuP 2015 requirements.
- The AUTO_{ADAPT} function ensures energy savings.
- FLOW_{ADAPT} which is a combination of the well-known AUTO_{ADAPT} control mode and a new FLOW_{LIMIT} function.
- Built-in Grundfos differential-pressure and temperature sensor.
- Safe selection.
- Simple installation.
- No maintenance and long life.
- Extended user interface with TFT display.
- Control panel with self-explanatory push-buttons made of high-quality silicone.
- Work log history.
- Easy system optimisation.
- Heat energy meter.
- Multi-pump function.
- External control and monitoring enabled via add-on modules.
- The complete range is available for a maximum system pressure of 16 bar (PN 16).

Main applications

Heating systems

- Main pump
- mixing loops
- domestic hot water
- heating surfaces
- air-conditioning surfaces.

The MAGNA3 circulator pumps are designed for circulating liquids in heating systems with variable flows where it is desirable to optimise the setting of the pump duty point, thus reducing energy costs. The pumps are also suitable for domestic hot-water systems.

To ensure correct operation, it is important that the sizing range of the system falls within the duty range of the pump.

The pump is especially suitable for installation in existing systems where the differential pressure across the pump is too high in periods with reduced flow demand. The pump is also suitable for new systems where automatic adjustment of pump head to actual flow demand is required, without using expensive bypass valves or similar components.

Furthermore, the pump is suitable for systems with hot-water priority as an external signal can immediately force the pump to operate according to the max. curve, for example in solar-heating systems.

Type key

Code	Example	MAGNA3	(D)	80	-120	(F)	(N)	360
	Type range MAGNA3							
D	Single-head pump Twin-head pump							
	Nominal diameter (DN) of suction and discharge ports [mm]							
	Maximum head [dm]							
F	Pipe connection Flange							
N	Pump housing material Cast iron Stainless steel							
	Port-to-port length [mm]							

Performance range, MAGNA3

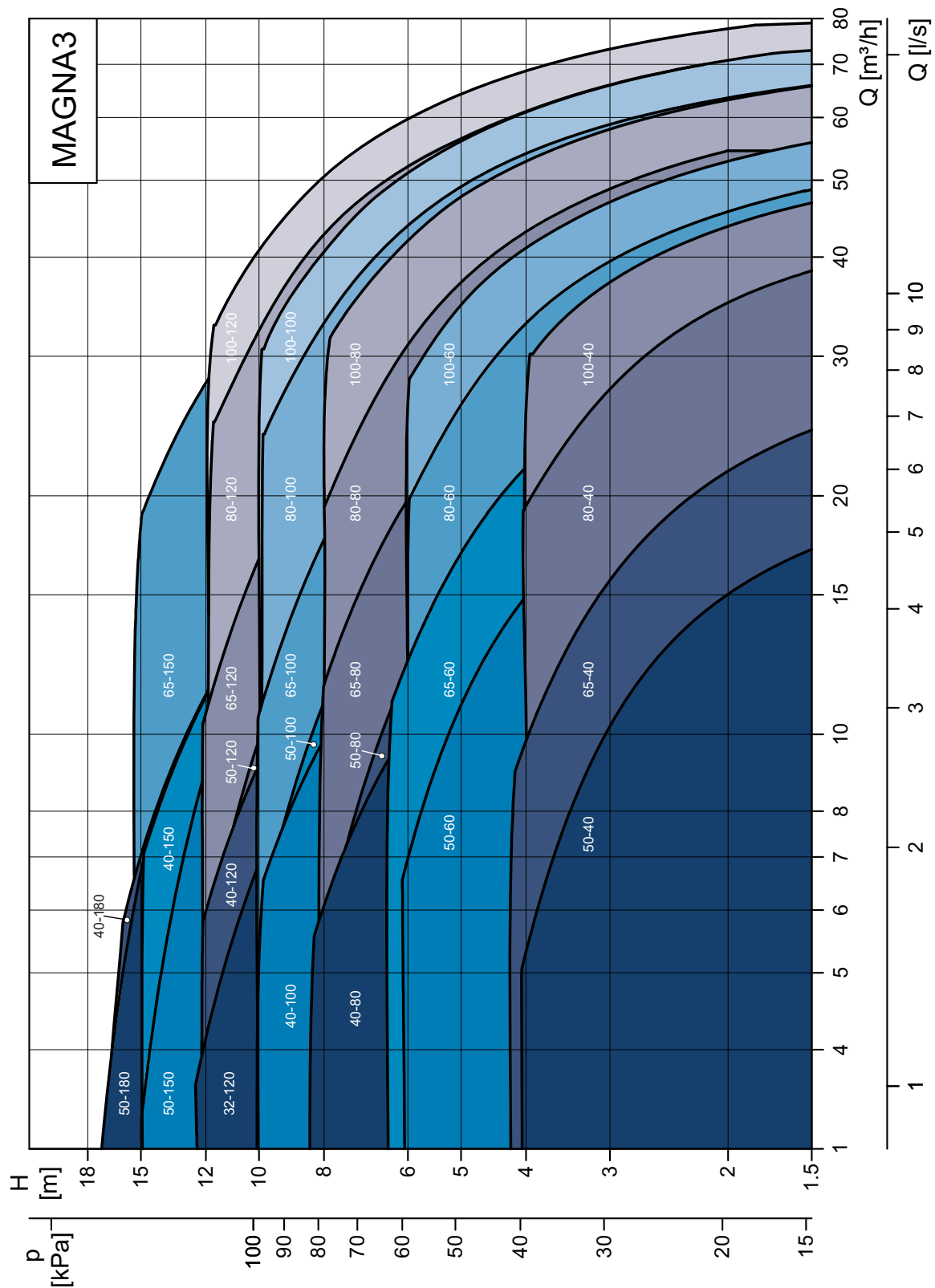

Fig. 2 Performance range, MAGNA3

TM05 2410 1812

Performance range, MAGNA3 D single-head operation

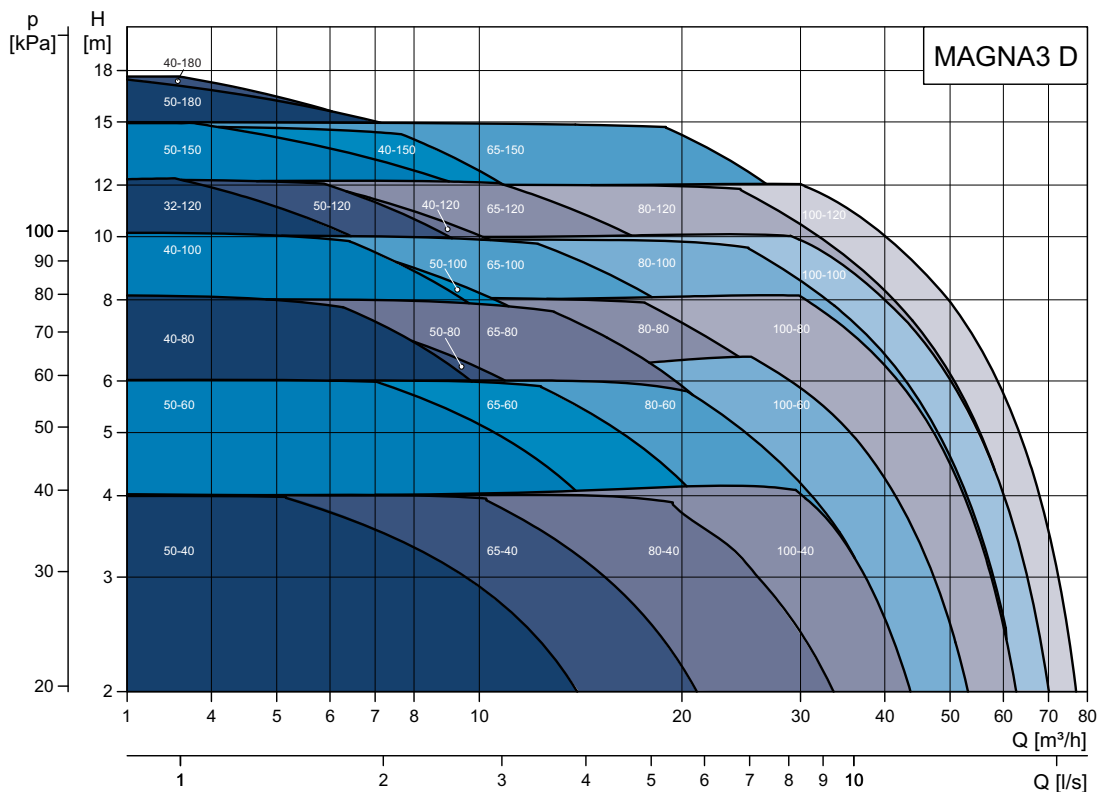

Fig. 3 Performance range, MAGNA3 D single-head operation

TM05 3937 1812

Performance range, MAGNA3 D twin-head operation

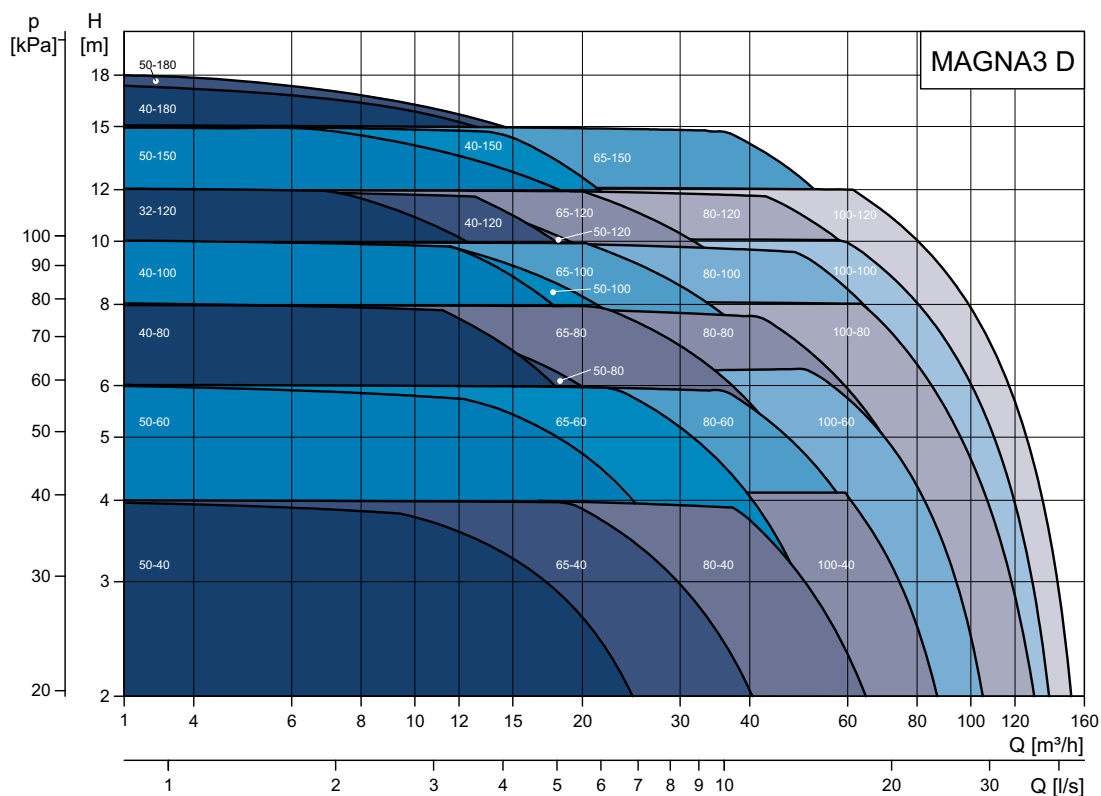

Fig. 4 Performance range, MAGNA3 D twin-head operation

TM05 3938 1812

2. Product range

Single-head pump	Port-to-port length [mm]	Cast iron				Stainless steel	Data sheet Page
		PN 6	PN 10	PN 6/10	PN 16	PN 6/10	
MAGNA3 32-120 F (N)	220			•	•	•	48
MAGNA3 40-80 F (N)	220			•	•	•	50
MAGNA3 40-100 F (N)	220			•	•	•	52
MAGNA3 40-120 F (N)	250			•	•	•	54
MAGNA3 40-150 F (N)	250			•	•	•	56
MAGNA3 40-180 F (N)	250			•	•	•	58
MAGNA3 50-40 F (N)	240			•	•	•	60
MAGNA3 50-60 F (N)	240			•	•	•	62
MAGNA3 50-80 F (N)	240			•	•	•	64
MAGNA3 50-100 F (N)	280			•	•	•	66
MAGNA3 50-120 F (N)	280			•	•	•	68
MAGNA3 50-150 F (N)	280			•	•	•	70
MAGNA3 50-180 F (N)	280			•	•	•	72
MAGNA3 65-40 F (N)	340			•	•	•	74
MAGNA3 65-60 F (N)	340			•	•	•	76
MAGNA3 65-80 F (N)	340			•	•	•	78
MAGNA3 65-100 F (N)	340			•	•	•	80
MAGNA3 65-120 F (N)	340			•	•	•	82
MAGNA3 65-150 F (N)	340			•	•	•	84
MAGNA3 80-40 F	360	•	•		•		86
MAGNA3 80-60 F	360	•	•		•		88
MAGNA3 80-80 F	360	•	•		•		90
MAGNA3 80-100 F	360	•	•		•		92
MAGNA3 80-120 F	360	•	•		•		94
MAGNA3 100-40 F	450	•	•		•		96
MAGNA3 100-60 F	450	•	•		•		98
MAGNA3 100-80 F	450	•	•		•		100
MAGNA3 100-100 F	450	•	•		•		102
MAGNA3 100-120 F	450	•	•		•		104

Twin-head pump	Port-to-port length [mm]	Cast iron				Data sheet Page
		PN 6	PN 10	PN 6/10	PN 16	
MAGNA3 D 32-120 F	220			•	•	49
MAGNA3 D 40-80 F	220			•	•	51
MAGNA3 D 40-100 F	220			•	•	53
MAGNA3 D 40-120 F	250			•	•	55
MAGNA3 D 40-150 F	250			•	•	57
MAGNA3 D 40-180 F	250			•	•	59
MAGNA3 D 50-40 F	240			•	•	61
MAGNA3 D 50-60 F	240			•	•	63
MAGNA3 D 50-80 F	240			•	•	65
MAGNA3 D 50-100 F	280			•	•	67
MAGNA3 D 50-120 F	280			•	•	69
MAGNA3 D 50-150 F	280			•	•	71
MAGNA3 D 50-180 F	280			•	•	73
MAGNA3 D 65-40 F	340			•	•	75
MAGNA3 D 65-60 F	340			•	•	77
MAGNA3 D 65-80 F	340			•	•	79
MAGNA3 D 65-100 F	340			•	•	81
MAGNA3 D 65-120 F	340			•	•	83
MAGNA3 D 65-150 F	340			•	•	85
MAGNA3 D 80-40 F	360	•	•		•	87
MAGNA3 D 80-60 F	360	•	•		•	89
MAGNA3 D 80-80 F	360	•	•		•	91
MAGNA3 D 80-100 F	360	•	•		•	93
MAGNA3 D 80-120 F	360	•	•		•	95
MAGNA3 D 100-40 F	450	•	•		•	97
MAGNA3 D 100-60 F	450	•	•		•	99
MAGNA3 D 100-80 F	450	•	•		•	101
MAGNA3 D 100-100 F	450	•	•		•	103
MAGNA3 D 100-120 F	450	•	•		•	105

Note: The product numbers of the various pump variants can be found on page 106.

Pump selection

All pumps have a "best point" (η_{\max}), indicating where the pump is working most efficiently.

Besides, the pump with the best efficiency must be chosen.

The parameters in the following should also be considered.

Pump size

The system characteristic is used together with the pump's performance curve for sizing and correct pump selection.

The selection of pump size should be based on the following:

- required maximum flow
- maximum pressure loss in the system.

Refer to the system characteristics to determine the duty point. See fig. 5.

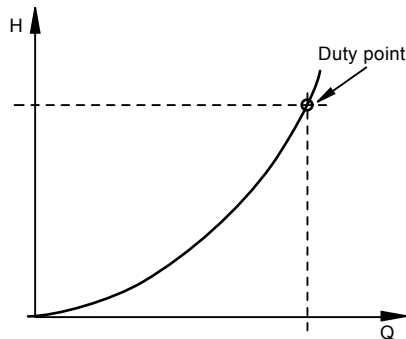

Fig. 5 System characteristic

TM02 2040 3301

Operating conditions

It should be checked whether the operating conditions are fulfilled, i.e.

- liquid quality and temperature
- ambient conditions
- minimum inlet pressure
- maximum operating pressure.

Control modes

- $AUTO_{ADAPT}$ (factory setting) which is suitable for most installations.
- $FLOW_{ADAPT}$ in systems where a flow limitation, $FLOW_{LIMIT}$, is required.
- Proportional-pressure control in systems with considerable pressure losses in relation to large flow variations.
- Constant-pressure control in systems with insignificant pressure losses in relation to large flow variations.
- Constant-temperature control in heating systems with a fixed system characteristic, for example domestic hot-water systems.
- Constant-curve duty.

Communication

The Grundfos CIM modules (CIM = Communication Interface Module) enable the MAGNA3 to connect to standard fieldbus networks, offering substantial benefits:

- complete process control and monitoring
- modular design, prepared for future requirements
- based on standard functional profiles
- simple configuration and easy installation
- open communication standards
- reading warning and alarm indications.

For further details, see section *CIM modules*, pages 25 and 26.

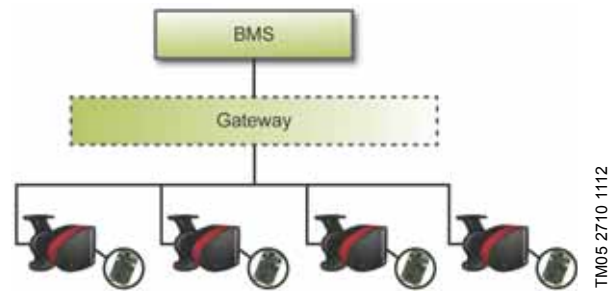

Fig. 6 Example of typical building management system (BMS)

Note: A gateway is a device that facilitates the transfer of data between two different networks based on different communication protocols.

TM05 2710 1112

3. Functions

System application

Heating systems

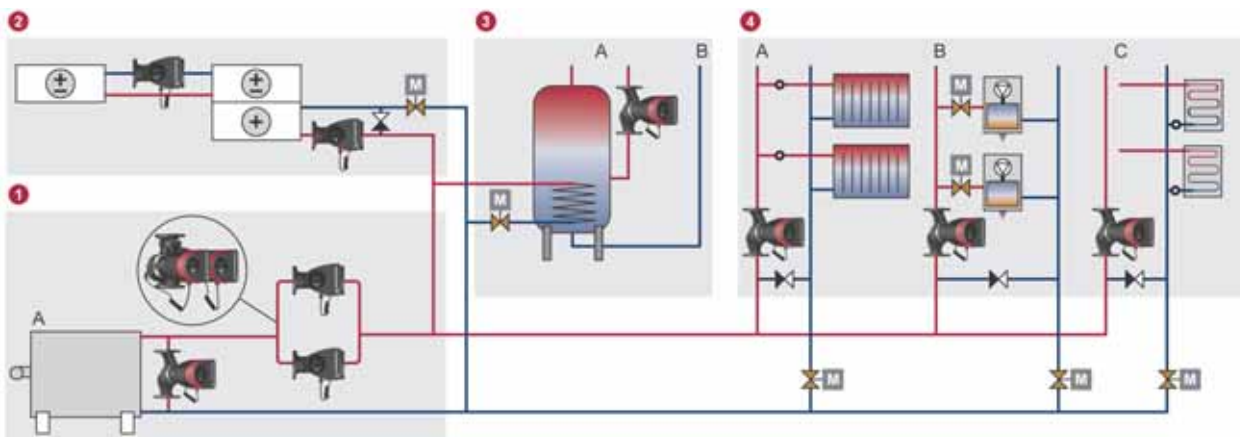

TM05 2155 1312

Fig. 7 Functional drawing of a heating system in a commercial building

Pos.	Description
①	Main pumps
A	Boiler
②	Air handler heating coils
③	Domestic hot water
A	Hot-water circulation
B	Cold water
④	Mixing loops
A	Radiators
B	Fan coils
C	Underfloor heating

Main pumps

Due to variations in the heat demand and water flow rate, we always recommend to use speed-controlled MAGNA3 pumps in a heating system, either single-head pumps connected in parallel or twin-head pumps. Single-head pumps connected in parallel have several advantages. In alternating operation, each pump is sized for 100 % flow. In this operating mode, the second pump functions as back-up for higher reliability. As the pumps alternate, an equal number of operating hours is ensured. Cascade operation of pumps connected in parallel meets demands in high-flow systems with low differential temperature (Δt), and 50 % back-up is ensured at the same time.

The twin-head pump saves installation time and costs. By speed-controlling all pumps, it is possible to obtain maximum energy saving as the pumps will run at their best efficiency point (BEP).

In a variable-flow system, we recommend to control main pumps in proportional-pressure or $AUTO_{ADAPT}$ mode with a differential-pressure sensor in the flow pipe with the lowest pressure. This ensures maximum energy saving.

By using the $FLOW_{ADAPT}$ function to ensure correct balancing of the system, the need for pump throttling valves can be reduced significantly.

The built-in heat energy meter allows monitoring of the heat energy consumption in the system for pure optimisation purposes.

Air handler heating coils

The performance of heating surfaces is controlled by the heating-water temperature and flow. For this purpose, we recommend to install variable-flow mixing loops at the heating surfaces. A speed-controlled mixing-loop pump is ideal for adaptation to the varying load in a heating surface. In this case, the MAGNA3 will have full authority, making external pump throttling valves superfluous.

Domestic hot water

For domestic hot-water circulation, the constant-temperature control mode will ensure a constant temperature in the recirculation pipe, without the use of separate thermostatic valves, thus obtaining the maximum comfort.

Mixing loops

Due to variations in use, flow temperature and heat demand in different parts of the building, the heating system should be divided into zones controlled by independent mixing loops. Due to the flow variations, a speed-controlled mixing-loop pump will have the authority in the system. This will help obtain a better hydraulic balance in the total system. Speed control of the pump via $AUTO_{ADAPT}$ ensures maximum energy saving.

Cooling systems

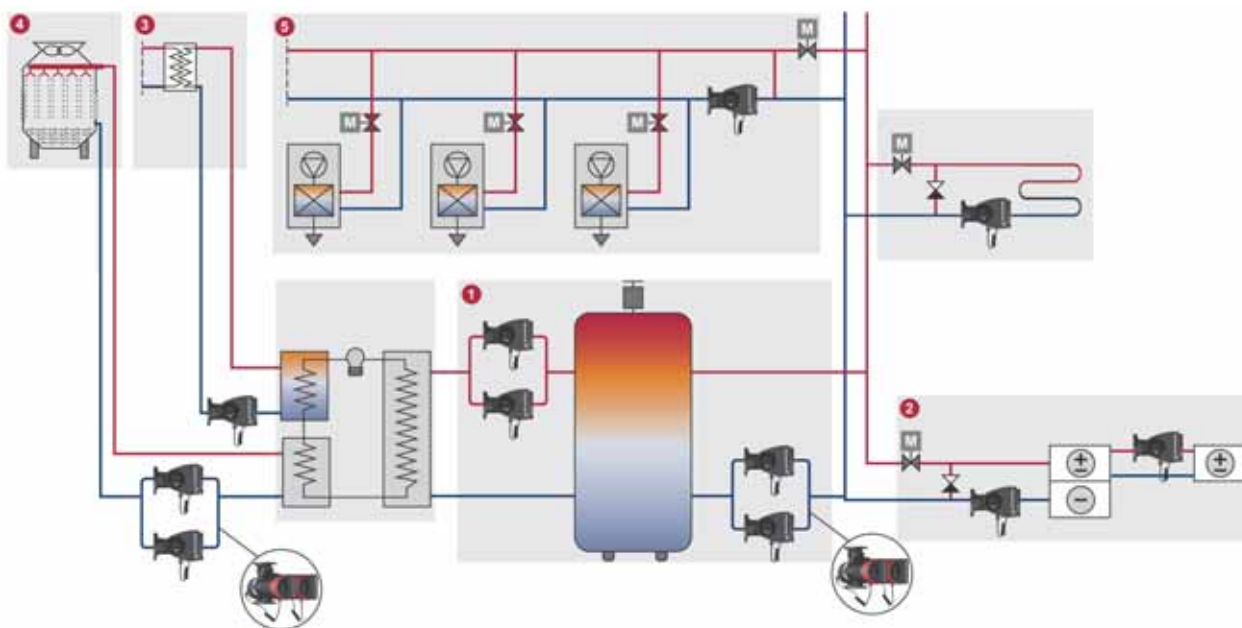

TM05 2156 1312

Fig. 8 Functional drawing of a cooling system in a commercial building

Pos.	Description
①	Primary and secondary pumps
②	Air handler cooling coils
③	Heat recovery system
④	Cooling tower
⑤	Mixing loops

Primary and secondary pumps

Due to variations in the cooling demand and water flow rate, we recommend to use speed-controlled MAGNA3 pumps in a cooling system, either single-head pumps connected in parallel or twin-head pumps. Single-head pumps connected in parallel have several advantages. In alternating operation, each pump is sized for 100 % flow. In this operating mode, the second pump functions as back-up for higher reliability. As the pumps alternate, an equal number of operating hours is ensured. Cascade operation of pumps connected in parallel meets demands in high-flow systems with low differential temperature (Δt), and 50 % back-up is ensured at the same time.

The twin-head pump saves installation time and costs. By speed-controlling all pumps, it is possible to obtain maximum energy saving as the pumps will run at their best efficiency point (BEP).

In a variable-flow system, we recommend to control secondary pumps in proportional-pressure or $AUTO_{ADAPT}$ mode with a differential-pressure sensor in the flow pipe with the lowest pressure. This ensures maximum energy saving.

The built-in heat energy meter allows monitoring of the heat energy consumption in the system.

Air handler cooling coils

The performance of cooling surfaces is controlled by the cooling-water temperature and flow. For this purpose, we recommend to install variable-flow mixing loops at the cooling surfaces. A speed-controlled mixing-loop pump is ideal for adaptation to the varying load in a cooling surface. In this case, the MAGNA3 will have full authority, making external pump throttling valves superfluous. The $FLOW_{LIMIT}$ ensures that the rated flow is never exceeded.

Heat recovery system

The heat recovery system is of paramount importance for the overall energy efficiency of an air-conditioning or cooling system. Pumps used for this purpose should be controlled by a setpoint from the building management system. Due to high load and temperature variations in the system, it is important to use variable-speed pumps in a heat recovery system.

Cooling tower

Due to chiller load variations and changes in the temperature and moisture of the ambient air, the cooling-tower flow rate is continuously changing. In order to achieve maximum energy saving, cooling-tower pumps have to be able to adapt to these varying conditions. The pumps are controlled by a temperature setpoint which is measured at the chiller's condenser. In this system, the MAGNA3 will have full authority, making pump throttling valves superfluous. The $FLOW_{LIMIT}$ ensures that the rated flow is never exceeded.

Mixing loops

Due to the risk of condensation, the flow temperature through a cooling ceiling or floor must never be lower than the dew point temperature of the indoor air. The dew point temperature is varying due to variations in indoor moisture load and outdoor thermal conditions. The result is that the cooling-water setpoint has to be controlled. A mixing loop is ideal for obtaining the correct temperature in order to adapt to the varying setpoint.

Due to continuous cooling-load variations in the building cooling zones, the cooling performance in cooling ceilings and floors is controlled by motor valves via zone control units, and a speed-controlled mixing-loop pump should always be used.

Solar-heating systems

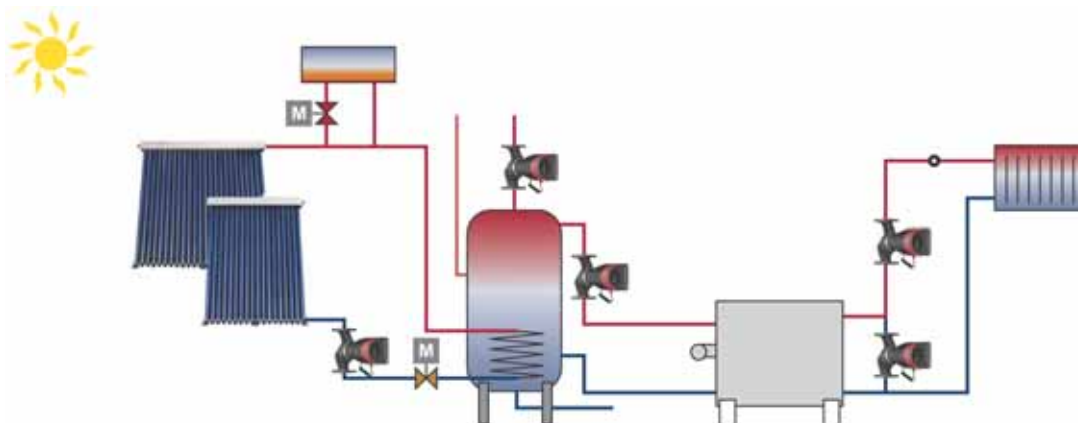

Fig. 9 Functional drawing of a solar-heating system

TM05 3421 1312

Main pumps

Solar-heating systems operate with very low flows compared to other heating systems, however, with relatively large pressure losses. With a conventional circulator pump, the flow must be minimised with a valve resulting in a significantly higher power consumption. To achieve major reductions in power consumption, the MAGNA3 is optimised with the $FLOW_{ADAPT}$ / $FLOW_{LIMIT}$ control mode for operation specifically under these conditions.

Ground source heat pump systems (GSHP)

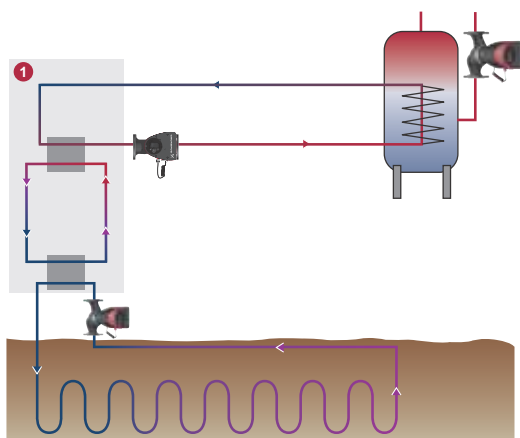

TM05 3422 1312

Fig. 10 Ground source heat pump system in a commercial building

Pos.	Description
1	Heat pump

Main pump

The MAGNA3 is optimised for operation as circulator pump in a closed-loop pipe system which is buried in the ground and filled with a mixture of water and antifreeze. The MAGNA3 is therefore ideal for large ground source heat pump systems for commercial buildings.

The MAGNA3 is designed for pumping liquids down to $-10\text{ }^{\circ}\text{C}$. It can cope with all known antifreeze compositions.

It is very important that all components are highly energy-efficient. No other circulator pump performs better in GSHP systems than the MAGNA3 with the $FLOW_{ADAPT}$ / $FLOW_{LIMIT}$ control mode.

Use the benefit of the inputs/outputs of the MAGNA3 to control the pump together with the heat pump.

Installation and commissioning

When installing MAGNA3, no external pressure sensor or motor protection is required. Installation is simple thanks to the built-in differential-pressure and temperature sensor, which enables proportional-pressure control without the installation of a sensor in the system.

In systems where a differential pressure is desired at a certain point of the system, an external pressure sensor must be installed.

Pump selection is based on required flow and calculated pressure losses. We recommend not to oversize the pump as it will lead to unnecessarily high energy consumption.

The MAGNA3 features the $FLOW_{LIMIT}$ function. In circuits where the MAGNA3 has full authority, the need for external pump throttling valves is reduced. The $FLOW_{LIMIT}$ ensures that the rated flow is never exceeded.

Selection of control mode

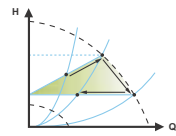
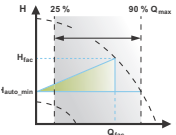
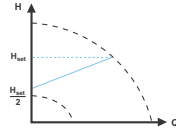
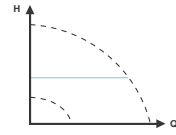
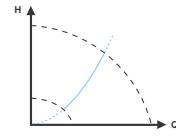
System application	Select this control mode
<p>Recommended for most heating systems, especially in systems with relatively large pressure losses in the distribution pipes. See description under proportional pressure.</p> <p>In replacement situations where the proportional-pressure duty point is unknown.</p> <p>The duty point has to be within the $AUTO_{ADAPT}$ operating range. During operation, the pump automatically makes the necessary adjustment to the actual system characteristic.</p> <p>This setting ensures minimum energy consumption and noise level from valves, which reduces operating costs and increases comfort.</p>	<p>$AUTO_{ADAPT}$</p> 
<p>The $FLOW_{ADAPT}$ control mode is a combination of $AUTO_{ADAPT}$ and $FLOW_{LIMIT}$.</p> <p>This control mode is suitable for systems where a maximum flow limit, $FLOW_{LIMIT}$, is desired. The pump continuously monitors and adjusts the flow, thus ensuring that the selected $FLOW_{LIMIT}$ is not exceeded.</p> <p>Main pumps in boiler applications where a steady flow through the boiler is required. No extra energy is used for pumping too much liquid into the system.</p> <p>In systems with mixing loops, the control mode can be used to control the flow in each loop.</p> <p>Benefits:</p>	<p>$FLOW_{ADAPT}$</p> 
<ul style="list-style-type: none"> • The dimensioned flow for each zone (required heat energy) is determined by the flow from the pump. This value can be set precisely in the $FLOW_{ADAPT}$ control mode without the use of pump throttling valves. • When the flow is set lower than the balancing valve setting, the pump will ramp down instead of losing energy by pumping against a balancing valve. • Cooling surfaces in air-conditioning systems can operate at high pressure and low flow. • Note: The pump cannot reduce the flow on the suction side, but is able to control that the flow on the discharge side is at least the same as on the suction side. This is due to the fact that the pump has no built-in valve. 	
<p>In systems with relatively large pressure losses in the distribution pipes and in air-conditioning and cooling systems.</p> <ul style="list-style-type: none"> • Two-pipe heating systems with thermostatic valves and <ul style="list-style-type: none"> – very long distribution pipes – strongly throttled pipe balancing valves – differential-pressure regulators – large pressure losses in those parts of the system through which the total quantity of water flows (for example boiler, heat exchanger and distribution pipe up to the first branching). • Primary circuit pumps in systems with large pressure losses in the primary circuit. • Air-conditioning systems with <ul style="list-style-type: none"> – heat exchangers (fan coils) – cooling ceilings – cooling surfaces. 	<p>Proportional pressure</p> 
<p>In systems with relatively small pressure losses in the distribution pipes.</p> <ul style="list-style-type: none"> • Two-pipe heating systems with thermostatic valves and <ul style="list-style-type: none"> – dimensioned for natural circulation – small pressure losses in those parts of the system through which the total quantity of water flows (for example boiler, heat exchanger and distribution pipe up to the first branching) or – modified to a high differential temperature between flow pipe and return pipe (for example district heating). • Underfloor heating systems with thermostatic valves. • One-pipe heating systems with thermostatic valves or pipe balancing valves. • Primary circuit pumps in systems with small pressure losses in the primary circuit. 	<p>Constant pressure</p> 
<p>In heating systems with a fixed system characteristic, for example domestic hot-water systems, the control of the pump according to a constant return-pipe temperature may be relevant. $FLOW_{LIMIT}$ can be used with advantage to control the maximum circulation flow.</p>	<p>Constant temperature</p> 

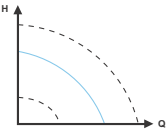
System application	Select this control mode
<p>If an external controller is installed, the pump is able to change from one constant curve to another, depending on the value of the external signal.</p> <p>The pump can also be set to operate according to the max. or min. curve, like an uncontrolled pump:</p> <ul style="list-style-type: none"> • The max. curve mode can be used in periods in which a maximum flow is required. This operating mode is for instance suitable for hot-water priority. • The min. curve mode can be used in periods in which a minimum flow is required. This operating mode is for instance suitable for manual night setback if Automatic Night Setback is not desired. 	<p>Constant curve</p> 
<p>In systems with pumps operating in parallel.</p> <p>The multi-pump function enables the control of single-head pumps connected in parallel (two pumps) and twin-head pumps without the use of external controllers. The pumps in a multi-pump system communicate with each other via the wireless GENlair connection.</p>	<p>"Assist" menu Multi-pump setup</p>

Functions

	Page
Operating modes	
Normal (control modes enabled)	16
Stop	16
Min. curve	16
Max. curve	16
Control modes	
AUTO _{ADAPT} (factory setting)	16
FLOW _{ADAPT}	17
Proportional pressure	17
Constant pressure	17
Constant temperature	18
Constant curve	18
Additional features for control modes	
FLOW _{LIMIT}	19
Automatic Night Setback	19
Additional operating modes for multi-pump setup	
Alternating operation	21
Back-up operation	21
Cascade operation	21
Readings and settings on the pump	
Control panel and display	21
Operating status	23
Pump performance	23
Warning and alarm	23
Heat energy meter	23
Work log history	23
Input for external sensor	23
Grundfos Eye (status indicator)	24
Communication	
Wireless Grundfos GO Remote	24
Wireless GENIair connection	25
Pump information to BMS via CIM modules	25
Digital inputs	24
Relay outputs	24
Analog input	24
Bus via GENIbus	26
Bus via LonWorks	26
Bus via Profibus DP	26
Bus via Modbus RTU	26
Bus via BACnet MS/TP	26
Grundfos Remote Management	26

Operating modes

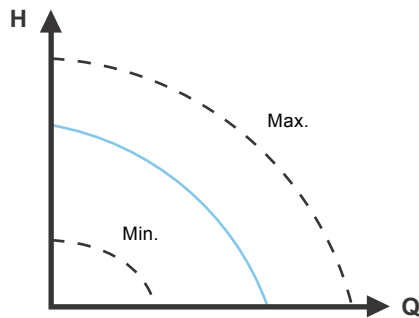

Fig. 11 Max. or min. curves

Normal: The pump runs according to the selected control mode.

Note: The control mode and setpoint can be selected even if the pump is not running in "Normal" mode.

Stop: The pump stops.

Min.: The min. curve mode can be used in periods in which a minimum flow is required. This operating mode is for instance suitable for manual night setback if Automatic Night Setback is not desired.

Max.: The max. curve mode can be used in periods in which a maximum flow is required. This operating mode is for instance suitable for hot-water priority.

The operating modes can be selected directly by use of the built-in digital inputs. See section *Digital inputs*, page 34.

Control modes

Factory setting

The pumps have been factory-set to $AUTO_{ADAPT}$ without Automatic Night Setback.

The setpoint has been factory-set to half of the maximum pump head.

The factory setting is suitable for most installations.

Note: When switched on via the power supply, the pump will start in $AUTO_{ADAPT}$ after approx. 5 seconds. If the buttons on the control panel are not touched for 15 minutes, the display will go into sleep mode. When a button is touched, the "Home" display will appear.

$AUTO_{ADAPT}$

Recommended for most heating systems.

During operation, the pump automatically makes the necessary adjustment to the actual system characteristic.

This setting ensures minimum energy consumption and noise level from valves, which reduces operating costs and increases comfort.

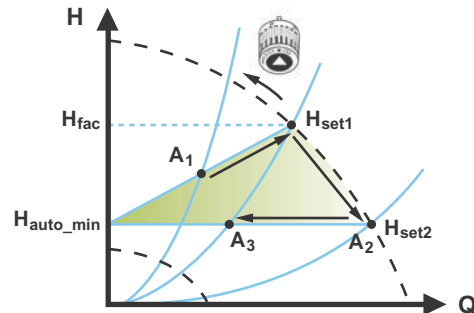

Fig. 12 $AUTO_{ADAPT}$ control

Note: Manual setting of the setpoint is not possible.

When the $AUTO_{ADAPT}$ control mode has been enabled, the pump will start with the factory setting, $H_{fac} = H_{set1}$, corresponding to approx. 55 % of its maximum head, and then adjust its performance to A_1 . See fig. 12.

When the pump registers a lower head on the max. curve, A_2 , the $AUTO_{ADAPT}$ function automatically selects a correspondingly lower control curve, H_{set2} . If the valves in the system close, the pump adjusts its performance to A_3 .

- A_1 : Original duty point.
- A_2 : Lower registered head on the max. curve.
- A_3 : New duty point after $AUTO_{ADAPT}$ control.
- H_{set1} : Original setpoint setting.
- H_{set2} : New setpoint after $AUTO_{ADAPT}$ control.
- H_{fac} : See section *Setting values for control modes*, page 20.
- H_{auto_min} : A fixed value of 1.5 m.

The $AUTO_{ADAPT}$ control mode is a form of proportional-pressure control where the control curves have a fixed origin, H_{auto_min} .

The $AUTO_{ADAPT}$ control mode has been developed specifically for heating systems and is not recommended for air-conditioning and cooling systems.

FLOW_{ADAPT}

The typical pump selection is based on required flow and calculated pressure losses. The pump is typically oversized by 30 to 40 % to ensure that it can overcome the pressure losses in the system.

To adjust the maximum flow of this "oversized" pump, balancing valves are built into the circuit to increase the resistance and thus reduce the flow. The FLOW_{ADAPT} function reduces the need for a pump throttling valve.

Note: This function cannot eliminate the need for balancing valves in heating systems.

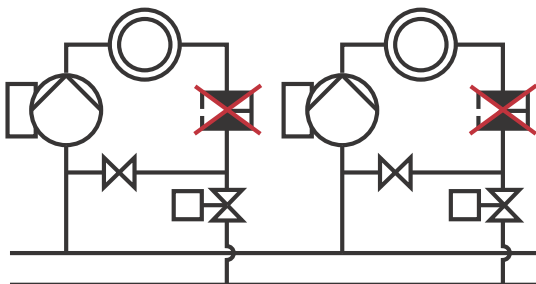

TM05 2685 1212

Fig. 13 Reduced need for a pump throttling valve

The FLOW_{ADAPT} control mode combines a control mode and a function:

- The pump is running AUTO_{ADAPT}.
- The flow will never exceed a selected FLOW_{LIMIT} value, which reduces the need for a pump throttling valve connected in series with the pump.

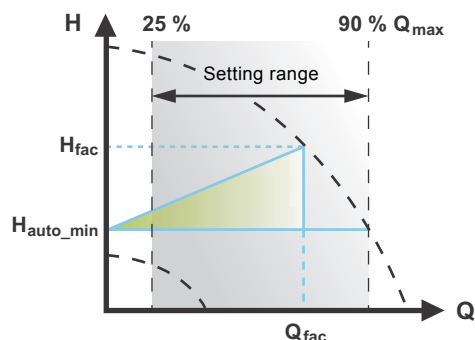

TM05 3334 1312

Fig. 14 FLOW_{ADAPT} control

When FLOW_{ADAPT} is selected, the pump will run AUTO_{ADAPT} and ensure that the flow never exceeds the entered FLOW_{LIMIT} value.

The setting range for the FLOW_{LIMIT} is 25 to 90 % of the Q_{max} of the pump.

The factory setting of the FLOW_{LIMIT} is the flow where the AUTO_{ADAPT} factory setting meets the max. curve. See fig. 14.

Note: Do not set the FLOW_{LIMIT} lower than the dimensioned duty point.

Proportional pressure

This control mode is used in systems with relatively large pressure losses in the distribution pipes. The head of the pump will increase proportionally to the flow in the system to compensate for the large pressure losses in the distribution pipes. The setpoint can be set with an accuracy of 0.1 metre.

The head against a closed valve is half the setpoint H_{set} .

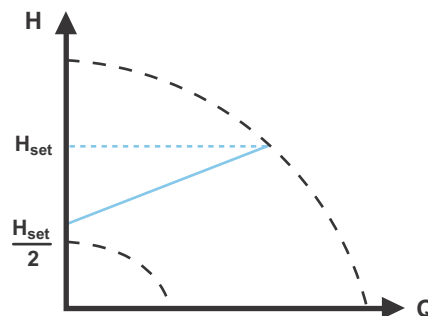

TM05 2448 1212

Fig. 15 Proportional-pressure control

Constant pressure

We recommend this control mode in systems with relatively small pressure losses.

The pump head is kept constant, independent of the flow in the system.

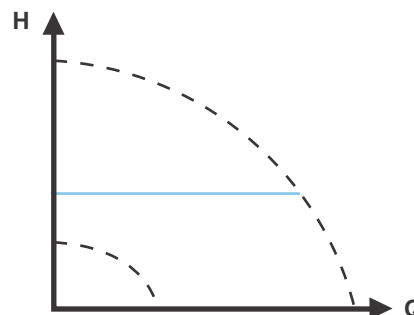

TM05 2449 0312

Fig. 16 Constant-pressure control

Constant temperature

In heating systems with a fixed system characteristic, for example domestic hot-water systems, the control of the pump according to a constant return-pipe temperature is relevant.

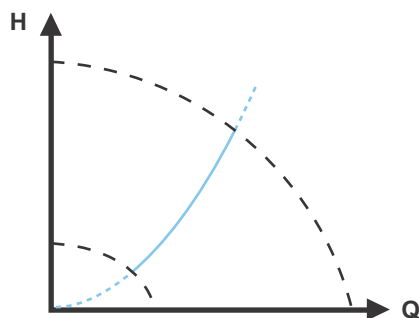

Fig. 17 Constant-temperature control

TM05 2451 5111

Temperature sensor

If the pump is installed in the flow pipe, an external temperature sensor must be installed in the return pipe of the system. See fig. 18. The sensor must be installed as close as possible to the consumer (radiator, heat exchanger, etc.).

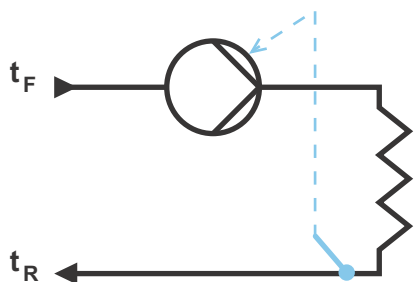

Fig. 18 Pump with external sensor

TM05 2615 0312

If the pump is installed in the return pipe of the system, the internal temperature sensor can be used. In this case, the pump must be installed as close as possible to the consumer (radiator, heat exchanger, etc.).

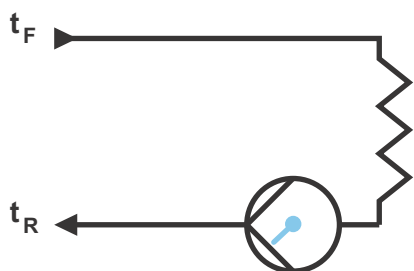

Fig. 19 Pump with internal sensor

TM05 2616 0312

Constant curve

The pump can be set to operate according to a constant curve, like an uncontrolled pump. See fig. 20. The desired speed can be set in % of maximum speed in the range from 25 to 100 %.

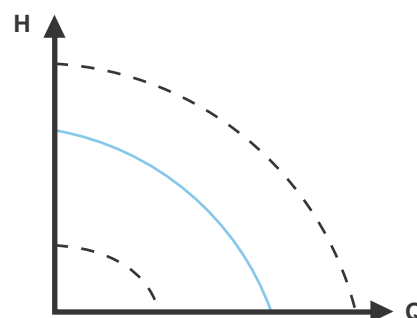

Fig. 20 Constant-curve duty

TM05 2446 5111

Note: Depending on the system characteristic and the duty point, the 100 % setting may be slightly smaller than the pump's actual max. curve even though the display shows 100 %. This is due to power and pressure limitations built into the pump. The deviation varies according to pump model and pressure losses in the pipes.

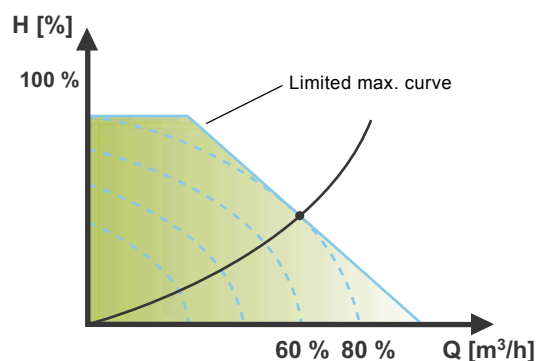

Fig. 21 Power and pressure limitations influencing the max. curve

TM05 4266 2212

The pump can also be set to operate according to the max. or min. curve, like an uncontrolled pump:

- The max. curve mode can be used in periods in which a maximum flow is required. This operating mode is for instance suitable for hot-water priority.
- The min. curve mode can be used in periods in which a minimum flow is required. This operating mode is for instance suitable for manual night setback if Automatic Night Setback is not desired.

These two operating modes can be selected via the digital inputs.

Additional features for control modes

The MAGNA3 offers additional features for the control modes to meet specific demands.

FLOW_{LIMIT}

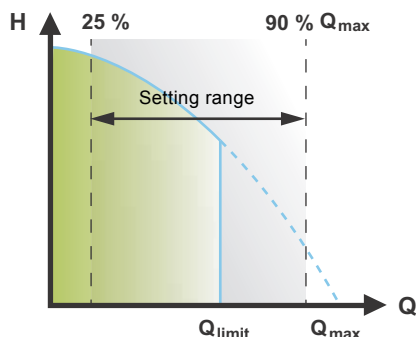

Fig. 22 FLOW_{LIMIT}

The FLOW_{LIMIT} function offers the possibility of limiting the maximum flow delivered by the pump.

The FLOW_{LIMIT} function can be enabled when the pump is in one of the following control modes:

- proportional pressure
- constant pressure
- constant temperature
- constant curve.

In the flow range between 0 and Q_{max} , the pump will run according to the selected control mode.

When Q_{max} is reached, the FLOW_{LIMIT} function will reduce the pump speed to ensure that the flow never exceeds the FLOW_{LIMIT} set, no matter if the system requires a higher flow due to a reduced resistance in the system. See fig. 23, 24 or 25.

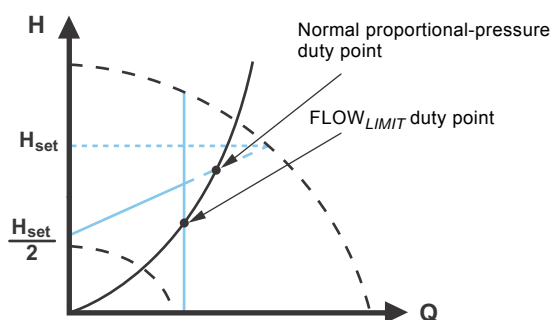

Fig. 23 Proportional-pressure control with FLOW_{LIMIT}

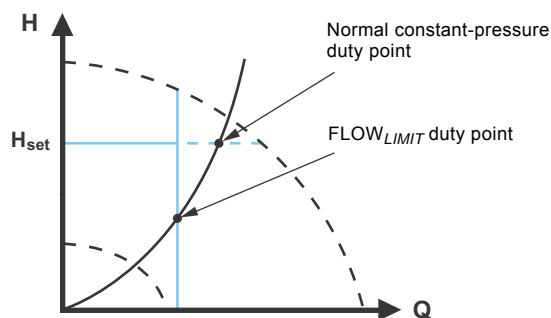

Fig. 24 Constant-pressure control with FLOW_{LIMIT}

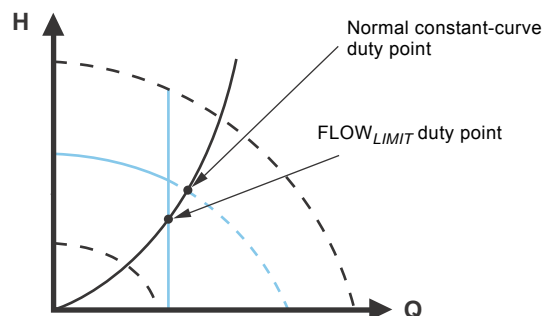

Fig. 25 Constant curve with FLOW_{LIMIT}

Automatic Night Setback

Once Automatic Night Setback has been enabled, the pump automatically changes between normal duty and night setback (duty at low performance).

When Automatic Night Setback has been enabled, the pump will run on the min. curve.

Changeover between normal duty and night setback depends on the flow-pipe temperature.

The pump automatically changes over to night setback when the built-in sensor registers a flow-pipe temperature drop of more than 10 to 15 °C within approx. two hours. The temperature drop must be at least 0.1 °C/min.

Changeover to normal duty takes place without a time lag when the temperature has increased by approx. 10 °C.

Note: Automatic Night Setback cannot be enabled when the pump is in constant-curve mode.

TM05 2444 0312

TM05 2445 1312

TM05 2542 0412

TM05 2543 0412

Setting values for control modes

The setting values for $FLOW_{ADAPT}$ and $FLOW_{LIMIT}$ are indicated as percent of Q_{max} , but the value has to be entered in m^3/h in the "Settings" menu. See fig. 26.

Pump type	AUTO _{ADAPT}	Q_{max}	FLOW _{ADAPT} / FLOW _{LIMIT}		
	H_{fac}		Q_{fac}	Q_{min} 25 %	Q_{max} 90 %
	[m]				
MAGNA3 (D) 32-120 F (N)	6.5	19.5	12	4.9	17.5
MAGNA3 (D) 40-80 F (N)	4.5	21.5	13	5.4	19.4
MAGNA3 (D) 40-100 F (N)	5.5	23.5	15	5.9	21.2
MAGNA3 (D) 40-120 F (N)	6.5	25.5	16	6.4	23.0
MAGNA3 (D) 40-150 F (N)	8.0	28.5	18	7.1	25.7
MAGNA3 (D) 40-180 F (N)	9.5	28.5	15	7.1	25.7
MAGNA3 (D) 50-40 F (N)	2.5	21.5	13	5.4	19.4
MAGNA3 (D) 50-60 F (N)	3.5	26.5	17	6.6	23.9
MAGNA3 (D) 50-80 F (N)	4.5	29.5	17	7.4	26.6
MAGNA3 (D) 50-100 F (N)	5.5	31.5	18	7.9	28.4
MAGNA3 (D) 50-120 F (N)	6.5	35.5	19	8.9	32.0
MAGNA3 (D) 50-150 F (N)	8.0	37.5	20	9.4	33.8
MAGNA3 (D) 50-180 F (N)	9.5	39.5	19	9.9	35.6
MAGNA3 (D) 65-40 F (N)	2.5	29.5	18	7.4	26.6
MAGNA3 (D) 65-60 F (N)	3.5	36.5	24	9.1	32.9
MAGNA3 (D) 65-80 F (N)	4.5	40.5	25	10.1	36.5
MAGNA3 (D) 65-100 F (N)	5.5	43.5	26	10.9	39.2
MAGNA3 (D) 65-120 F (N)	6.5	47.5	30	11.9	42.8
MAGNA3 (D) 65-150 F (N)	8.0	56.5	40	14.1	50.9
MAGNA3 (D) 80-40 F	2.5	41.5	32	10.4	37.4
MAGNA3 (D) 80-60 F	3.5	48.5	37	12.1	43.7
MAGNA3 (D) 80-80 F	4.5	54.5	40	13.6	49.1
MAGNA3 (D) 80-100 F	5.5	67.5	47	16.9	60.8
MAGNA3 (D) 80-120 F	6.5	72.5	48	18.1	65.3
MAGNA3 (D) 100-40 F	2.5	52.5	40	13.1	47.3
MAGNA3 (D) 100-60 F	3.5	59.5	43	14.9	53.6
MAGNA3 (D) 100-80 F	4.5	67.5	50	16.9	60.8
MAGNA3 (D) 100-100 F	5.5	73.5	52	18.4	66.2
MAGNA3 (D) 100-120 F	6.5	78.5	57	19.6	70.7

The operating range for proportional-pressure and constant-pressure control appears from the individual data sheet. Constant-curve duty: 0 to 100 % speed.

Additional operating modes for multi-pump setup

Multi-pump function

The multi-pump function enables the control of single-head pumps connected in parallel and twin-head pumps without the use of external controllers. The pumps in a multi-pump system communicate with each other via the wireless GENlair connection.

A multi-pump system is set up via a selected pump, i.e. the master pump (first selected pump). All Grundfos pumps with a wireless GENlair connection can be connected to the multi-pump system.

The multi-pump functions are described in the following sections.

Alternating operation

Only one pump is operating at a time. The change from one pump to the other depends on time or energy. If a pump fails, the other pump will take over automatically.

Pump system:

- Twin-head pump.
- Two single-head pumps connected in parallel. The pumps must be of equal size and type. Each pump requires a non-return valve in series with the pump.

Back-up operation

One pump is operating continuously. The back-up pump is operated at intervals to prevent seizing up. If the duty pump stops due to a fault, the back-up pump will start automatically.

Pump system:

- Twin-head pump.
- Two single-head pumps connected in parallel. The pumps must be of equal size and type. Each pump requires a non-return valve in series with the pump.

Cascade operation

Cascade operation ensures that the pump performance is automatically adapted to the consumption by switching pumps on or off. The system thus runs as energy-efficiently as possible with a constant pressure and a limited number of pumps.

The back-up of a twin-head pump will start at 90 % and stop at 50 % performance when operating in constant-pressure mode.

It can be advantageous to choose a twin-head pump, as the back-up pump will start for a short period in peak-load situations. If an oversized single-head pump is chosen, it may run outside its best efficiency range most of the time.

All pumps in operation will run at equal speed. Pump changeover is automatic and depends on speed, operating hours and fault.

Pump system:

- Twin-head pump.
- Two single-head pumps connected in parallel. The pumps must be of equal size and type. Each pump requires a non-return valve in series with the pump.
- The control mode must be set to "Const. press." or "Constant curve".

Readings and settings on the pump

Control panel and display

The MAGNA3 pump features a 4" TFT display with intuitive and user-friendly interface. The control panel has self-explanatory push-buttons made of high-quality silicone for precise navigation in the menu structure. The control panel is designed to give the user quick and easy access to pump and performance data on site.

When the pump is started up for the first time, the user is presented with a start-up guide enabling easy setting of the pump. Additionally, the "Assist" menu can guide the user through the various settings of the pump.



TM05 3820 1612

Fig. 26 Control panel

Button	Function
	Goes to the "Home" menu.
	Returns to the previous action.
	Navigates between main menus, displays and digits. When the menu is changed, the display will always show the top display of the new menu.
	Navigates between submenus.
	Saves changed values, resets alarms and expands the value field.

Factory setting

The pumps have been factory-set to $AUTO_{ADAPT}$ without Automatic Night Setback.

Start-up guide

The start-up guide is used for the general settings of the pump. The start-up guide is started the first time the pump is connected to the power supply.

Note: If there has been no user action after pump start-up, the pump will automatically leave the start-up guide after 15 minutes with the language set to English.

The start-up guide can be run again in the "Settings" menu. If the start-up guide is run again, all previous settings will be lost.

"Home" menu

This menu gives an overview of up to four user-defined parameters or a graphical illustration of a Q/H performance curve.

This menu offers the following (factory setting):

- Shortcut to Control mode settings
- Shortcut to Setpoint settings
- Flow rate
- Head.

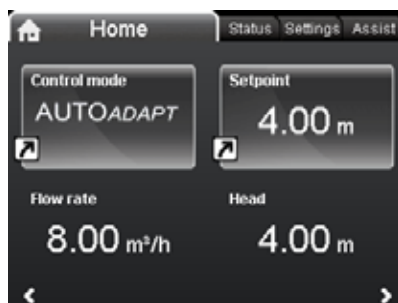

Fig. 27 "Home" menu

Home

"Status" menu

This menu shows the status of the pump and system as well as warnings and alarms.

Note: No settings can be made in this menu.

This menu offers the following:

- Operating status
- Pump performance
- Power and energy consumption
- Warning and alarm
- Heat energy meter
- Work log
- Fitted modules
- Date and time
- Pump identification
- Multi-pump system.

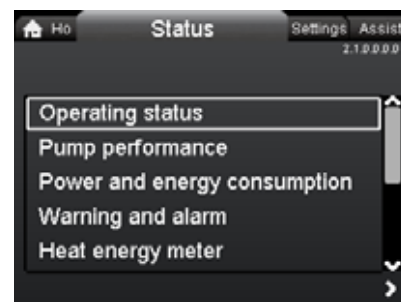

Fig. 28 "Status" menu

Status

"Settings" menu

This menu gives access to all setting parameters. A detailed setting of the pump can be made in this menu.

This menu offers the following setting options:

- Setpoint
- Operating mode
- Control mode
- $FLOW_{LIMIT}$
- Automatic Night Setback
- Relay outputs
- Setpoint influence
- Bus communication
- General settings.

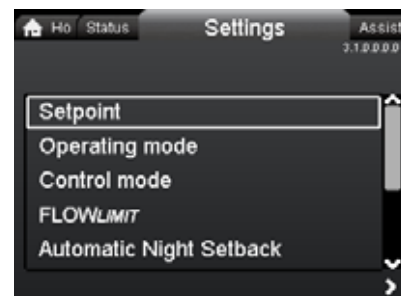

Fig. 29 "Settings" menu

Settings

"Assist" menu

The "Assist" menu guides the user through the setting of the pump. In each submenu, the user is presented with a guide that assists throughout the setting.

This menu offers the following:

- Step-by-step instructions in how to set up the pump.
- A short description of the six control modes and recommended applications.
- Assistance in fault correction.

Submenus:

- Assisted pump setup
- Setting of date and time
- Multi-pump setup
- Setup, analog input
- Description of control mode
- Assisted fault advice.

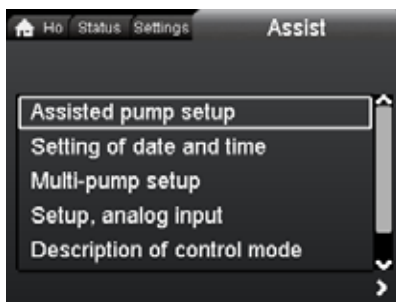

Fig. 30 "Assist" menu

Operating status

"Operating status" shows the current operating mode and the selected control mode, if any.

Pump performance

"Pump performance" offers the following:

- Q/H graph showing current duty point, flow, head, power and liquid temperature.
- "Resulting setpoint" shows the setpoint set on the pump, the external influence and the resulting setpoint.
- Liquid temperature.
- Speed.
- Operating hours.

Warning and alarm

"Warning and alarm" offers the following:

- Actual warning or alarm, if any.
- Information about when the warning/alarm occurred and disappeared and about corrective actions.
- Warning and alarm logs.

Heat energy meter

"Heat energy meter" is a monitoring function which makes it possible to track the heat energy distribution and consumption within a system. This prevents excessive energy costs caused by system imbalances.

- The heat energy meter has an accuracy between ± 1 and 10 %, i.e. ideal for optimisation purposes.
- Temperature input from the return pipe. The temperature sensor is not supplied with the pump.

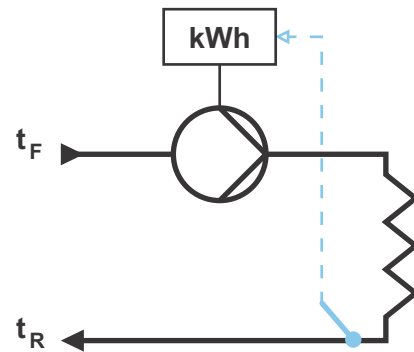

Fig. 31 MAGNA3 with built-in heat energy meter

Note: MAGNA3 incorporates a calculator for flow and flow-pipe temperature.

For further details, see section *External sensors*, page 45.

Work log history

"Work log history" offers the following:

- Every duty point and the operating conditions are tracked and stored in the pump.
- The 3D work log and duty curve (over time) provide instant overviews of historical pump performance and operating conditions.
- The perfect tool for pump optimisation, replacement and fault finding.

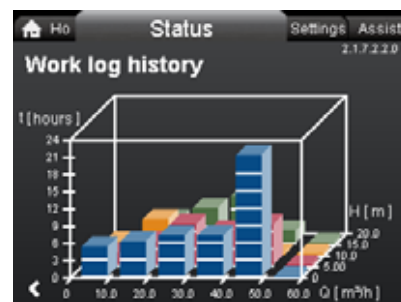

Fig. 32 Example of "Work log history"

Input for external sensor

An external differential-pressure sensor can be used to control the flow in the system to obtain the externally set pressure, which results in following benefits:

- Minimises operating costs.
- Prevents valve noise.
- Ensures comfort (enough pressure).

Grundfos Eye

The Grundfos Eye at the top of the control panel is a pump status indicator light providing information about the pump operating status.

The indicator light will flash in different sequences and provide information about the following:

- power on/off
- pump warnings
- pump alarms
- remote control.

The function of the Grundfos Eye is described in detail in the installation and operating instructions.



<http://GRUNDFOS.COM/MAGNA3-MANUAL>



Fig. 33 Grundfos Eye

TM05 3810 1612

Communication

The MAGNA3 enables communication via the following:

- wireless Grundfos GO Remote
- fieldbus communication via CIM modules
- digital inputs
- relay outputs
- analog input.

Grundfos GO Remote



Fig. 34 Grundfos GO Remote

TM05 3825 1712

The MAGNA3 is designed for wireless communication with the Grundfos GO Remote.

For more details, see section *Grundfos GO Remote*, page 38.

The Grundfos GO Remote offers additional possibilities of setting and status displays for the pump.

The Grundfos GO Remote can be used for the following functions:

- Reading of operating data.
- Reading of warning and alarm indications.
- Setting of control mode.
- Setting of setpoint.
- Selection of external setpoint signal.
- Allocation of pump number making it possible to distinguish between pumps that are connected via Grundfos GENIbus.
- Selection of function for digital input.
- Generation of reports (PDF).
- Assist function.
- Multi-pump setup.
- Displaying relevant documentation.

Wireless GENlair

The pump is designed for multi-pump connection via the wireless GENlair connection.

The built-in wireless GENlair module enables communication between pumps and with the Grundfos GO Remote without the use of add-on modules.

- Multi-pump function.
See section *Multi-pump function*.
- Grundfos GO Remote.
See section *Grundfos GO Remote*.

CIM modules



TM05 3811 1612

Fig. 35 Grundfos CIM modules

A CIM module is an add-on Communication Interface Module. The CIM module enables data transmission between the pump and an external system, for example a BMS (Building Management System) or SCADA system.

The CIM module communicates via fieldbus protocols. Available CIM modules can be found on page 26.

Connection to network

The pump can be connected to a LON network via the wireless GENlair connection or by fitting a CIM module. See section *CIM modules*, page 36.

Other types of network connections are also possible. Contact Grundfos for further information on how to connect to your network.







Grundfos Remote Management

Grundfos Remote Management is an easy-to-install, low-cost solution for wireless monitoring and management of Grundfos products. It is based on a centrally hosted database and a web server with wireless data collection via GSM/GPRS modem. The system only requires an internet connection, a web browser, a GRM modem and an antenna as well as a contract with Grundfos allowing you to monitor and manage Grundfos pump systems.

You have wireless access to your account anywhere, anytime when you have an internet connection, for example via a smartphone, tablet PC, laptop or computer. Warnings and alarms can be sent by email or SMS to your mobile phone or computer.

For CIM communication interface module and GSM antennas, see section *Grundfos Remote Management*, page 37.

Available CIM modules

Module	Fieldbus protocol	Description	Functions
CIM 050 	GENIbus TM05 3812 1612	The CIM 050 is a Grundfos communication interface module used for communication with a GENIbus network.	The CIM 050 has terminals for the GENIbus connection.
CIM 100 	LonWorks TM05 3813 1612	The CIM 100 is a Grundfos communication interface module used for communication with a LonWorks network.	The CIM 100 has terminals for the LonWorks connection. Two LEDs are used to indicate the actual status of the CIM 100 communication. One LED is used for indication of correct connection to the pump, and the other is used to indicate LonWorks communication status.
CIM 150 	Profibus DP TM05 3814 1612	The CIM 150 is a Grundfos communication interface module used for communication with a Profibus network.	The CIM 150 has terminals for the Profibus DP connection. DIP switches are used to set line termination. Two hexadecimal rotary switches are used to set the Profibus DP address. Two LEDs are used to indicate the actual status of the CIM 150 communication. One LED is used for indication of correct connection to the pump, and the other is used to indicate Profibus communication status.
CIM 200 	Modbus RTU TM05 3815 1612	The CIM 200 is a Grundfos communication interface module used for communication with a Modbus RTU network.	The CIM 200 has terminals for the Modbus connection. DIP switches are used to select parity and stop bits, to select transmission speed and to set line termination. Two hexadecimal rotary switches are used to set the Modbus address. Two LEDs are used to indicate the actual status of the CIM 200 communication. One LED is used for indication of correct connection to the pump, and the other is used to indicate Modbus communication status.
CIM 270 	Grundfos Remote Management TM05 4432 2212	The CIM 270 is a Grundfos GSM/GPRS modem used for communication with a Grundfos Remote Management system. It requires a GSM antenna, a SIM card and a contract with Grundfos.	With the CIM 270 you have wireless access to your account anywhere, anytime when you have an internet connection, for example via a smartphone, tablet PC, laptop or computer. Warnings and alarms can be sent by email or SMS to your mobile phone or computer. You will get a complete status overview of the entire GRM system. It allows you to plan maintenance and service based on actual operating data.
CIM 300 	BACnet MS/TP TM05 3815 1612	The CIM 300 is a Grundfos communication interface module used for communication with a BACnet MS/TP network.	The CIM 300 has terminals for the BACnet MS/TP connection. DIP switches are used to set transmission speed and line termination and to select the custom Device Object Instance Number. Two hexadecimal rotary switches are used to set the BACnet address. Two LEDs are used to indicate the actual status of the CIM 300 communication. One LED is used for indication of correct connection to the pump, and the other is used to indicate BACnet communication status.

For product numbers, see section *CIM modules*, page 36.

4. Operating conditions

General recommendations

Water in heating systems	Water quality according to local standards such as the German standard VDI 2035
Domestic hot water	Degree of hardness up to 14 °dH
Water containing glycol	Maximum viscosity = 50 cSt ~ 50 % water/50 % ethylene glycol at -10 °C

Liquid temperature

Application	Temperature range
General	-10 to +110 °C
Domestic hot-water systems	Up to +65 °C recommended

Ambient conditions

Ambient conditions	
Ambient temperature during operation	0 to +40 °C
Ambient temperature during storage and transport	-40 to +70 °C
Relative air humidity	Maximum 95 %

Maximum operating pressure

PN 6: 6 bar / 0.6 MPa

PN 10: 10 bar / 1.0 MPa

PN 16: 16 bar / 1.6 MPa.

Minimum inlet pressure

The following relative minimum pressure must be available at the pump inlet during operation to avoid cavitation noise and damage to the pump bearings.

The values in the table below apply to single-head pumps and twin-head pumps in single-head operation.

MAGNA3 DN	Liquid temperature		
	75 °C	95 °C	110 °C
	Inlet pressure [bar] / [MPa]		
32-120	0.90 / 0.09	1.30 / 0.13	1.9 / 0.19
40-40/60	0.10 / 0.01	0.35 / 0.03	1.0 / 0.10
40-80/100	0.10 / 0.01	0.50 / 0.05	1.1 / 0.11
40-120/150/180	0.10 / 0.01	0.40 / 0.04	1.0 / 0.10
50-40/60/80	0.10 / 0.01	0.10 / 0.01	0.7 / 0.07
50-100	0.10 / 0.01	0.50 / 0.05	1.1 / 0.11
50-120	0.10 / 0.01	0.40 / 0.04	1.0 / 0.10
50-150/180	0.20 / 0.02	0.60 / 0.06	1.2 / 0.12
65-40/60/80/100	0.20 / 0.02	0.60 / 0.06	1.2 / 0.12
65-120	0.10 / 0.01	0.50 / 0.05	1.1 / 0.11
65-150	0.40 / 0.04	0.80 / 0.08	1.2 / 0.12
80-40/60/80/100/120	0.50 / 0.05	0.90 / 0.09	1.5 / 0.15
100-40/60/80/100/120	0.50 / 0.05	0.90 / 0.09	1.5 / 0.15

In the case of twin-head operation, the required relative inlet pressure must be increased by 0.1 bar / 0.01 MPa compared to the stated values for single-head pumps or twin-head pumps in single-head operation.

Note: Actual inlet pressure plus pump pressure against a closed valve must be lower than the maximum permissible system pressure.

The relative minimum inlet pressures apply to pumps installed up to 300 metres above sea level. For altitudes above 300 metres, the required relative inlet pressure must be increased by 0.1 bar / 0.01 MPa per 100 metres altitude. The MAGNA3 pump is only approved to a altitude of 2000 metres.

Pumped liquids

The pump is suitable for thin, clean, non-aggressive and non-explosive liquids, not containing solid particles or fibres that may attack the pump mechanically or chemically.

In heating systems, the water should meet the requirements of accepted standards on water quality in heating systems, for example the German standard VDI 2035.

In domestic hot-water systems, we recommend to use MAGNA3 pumps only for water with a degree of hardness lower than approx. 14 °dH.

In domestic hot-water systems, we recommend to keep the liquid temperature below +65 °C to eliminate the risk of lime precipitation.

The MAGNA3 pumps can be used for pumping water/glycol mixtures up to 50 %.

Example of a water/ethylene glycol mixture:

Maximum viscosity: 50 cSt ~ 50 % water/50 % ethylene glycol mixture at -10 °C.

The pump is controlled by a power-limiting function that protects against overload.

The pumping of glycol mixtures will affect the max. curve and reduce the performance, depending on the water/ethylene glycol mixture and the liquid temperature.

To prevent the ethylene glycol mixture from degrading, avoid temperatures exceeding the rated liquid temperature and minimise the operating time at high temperatures.

It is important to clean and flush the system before the ethylene glycol mixture is added.

To prevent corrosion or lime precipitation, check and maintain the ethylene glycol mixture regularly. If further dilution of the supplied ethylene glycol is required, follow the glycol supplier's instructions.

Differential-pressure and temperature sensor

The MAGNA3 incorporates a differential-pressure and temperature sensor. The sensor is located in the pump housing in a channel between the suction and discharge ports. The sensors of twin-head pumps are connected to the same channel and the pumps therefore register the same differential pressure and temperature.

Via a cable, the sensor sends an electrical signal for the differential pressure across the pump and for the liquid temperature to the controller in the control box.

In case of missing sensor signal, the pump will run at maximum speed. When the fault has been corrected, the pump will continue operating according to the parameters set.

The differential-pressure and temperature sensor offers substantial benefits:

- direct feedback on the pump display
- complete pump control
- measurement of the pump workload for precise and optimum control resulting in higher energy efficiency.

Electrical data

Pump type	MAGNA3 (D)
Enclosure class	IPX4D (EN 60529).
Insulation class	F.
Supply voltage	1 x 230 V ± 10 %, 50/60 Hz, PE.
Two digital inputs	External potential-free contact. Contact load: 5 V, 10 mA. Screened cable. Loop resistance: Maximum 130 Ω.
Analog input	4-20 mA (load: 150 Ω). 0-10 VDC (load: > 10 kΩ).
Two relay outputs	Internal potential-free changeover contact. Maximum load: 250 V, 2 A, AC1. Minimum load: 5 VDC, 20 mA. Screened cable, depending on signal level.
Bus input	Grundfos Communication Interface Modules (add-on CIM modules) for <ul style="list-style-type: none"> • GENibus • LonWorks • Profibus DP • Modbus RTU • BACnet MS/TP • Grundfos Remote Management.
Earth leakage current	$I_{leakage} < 3.5$ mA. The leakage currents are measured in accordance with EN 60335-1.
EMC	EN 55014-1:2006, EN 55014-2:1998, EN 61800-3-3:2008 and EN 61000-3-2:2006.
cos φ	The MAGNA3 has a built-in active PFC (Power Factor Control) which gives a cos φ from 0.98 to 0.99, i.e. very close to 1.
Consumption then the pump is stopped	1 to 10 W, depending on activity, i.e. reading the display, use of Grundfos GO Remote, interaction with modules, etc. 4 W, when pump is stopped and no activity.

Sound pressure level

Pump type	MAGNA3
Sound pressure level	≤ 43 dB(A)

5. Construction

The MAGNA3 is of the canned-rotor type, i.e. pump and motor form an integral unit without shaft seal and with only two gaskets for sealing. The bearings are lubricated by the pumped liquid.

The pump is characterised by the following:

- controller integrated in the control box
- control panel on the control box
- control box prepared for optional CIM modules
- built-in differential-pressure and temperature sensor
- cast-iron or stainless-steel pump housing
- twin-head versions
- no external motor protection required
- insulating shells supplied with single-head pumps for heating systems.

Motor and electronic controller

The MAGNA3 incorporates a 4-pole synchronous, permanent-magnet motor (PM motor). This motor type is characterised by higher efficiency than a conventional asynchronous squirrel-cage motor. The pump speed is controlled by an integrated frequency converter.

A differential-pressure and temperature sensor is incorporated in the pump.

Pump connections

Flange dimensions to EN 1092-2.

Surface treatment

The pump housing and pump head are electrocoated to improve the corrosion resistance.

Electrocoating includes:

- alkaline cleaning
- pretreatment with zinc phosphate coating
- cathodic electrocoating (epoxy)
- curing of paint film at 200 to 250 °C.

Colour

Colour codes for the pump:

Colour	Code
Red	NCS40-50R
Black	NCS9000

Sectional drawing

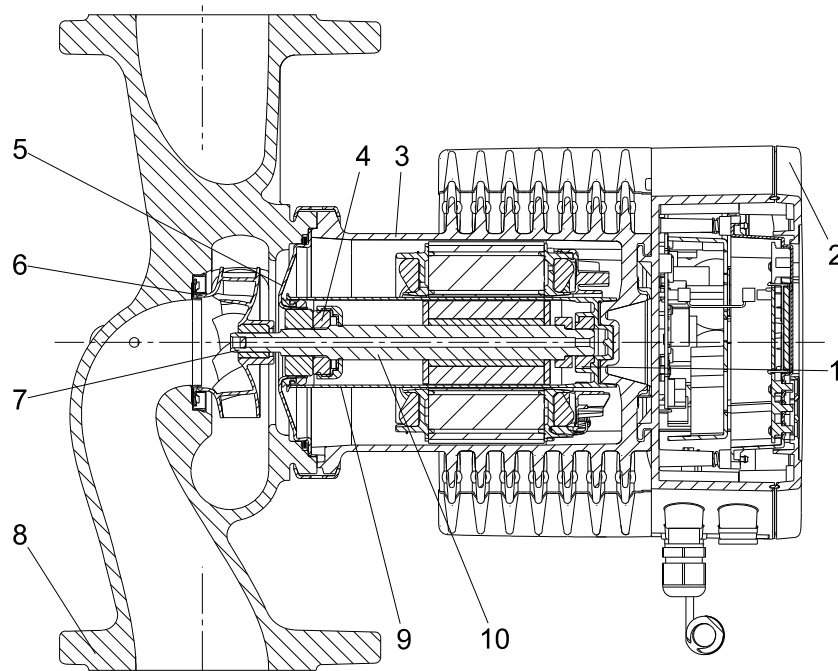

Fig. 36 MAGNA3

TM05 2319 0312

Material specification

See fig. 36.

Pos.	Component	Material	EN
1	Outer bearing ring	Aluminium oxide	
2	Control box	Polycarbonate	
3	Stator housing	Aluminium	
	O-rings	EPDM	
4	Thrust bearing	Aluminium oxide/carbon	
5	Bearing plate	Stainless steel	EN 1.4301
6	Neck ring	Stainless steel	EN 1.4301
7	Impeller	PES	
8	Pump housing	Cast iron/stainless steel	EN1561 EN-GJL-250/EN 1.4408
9	Rotor can	PPS	
10	Shaft	Stainless steel	EN 1.4404

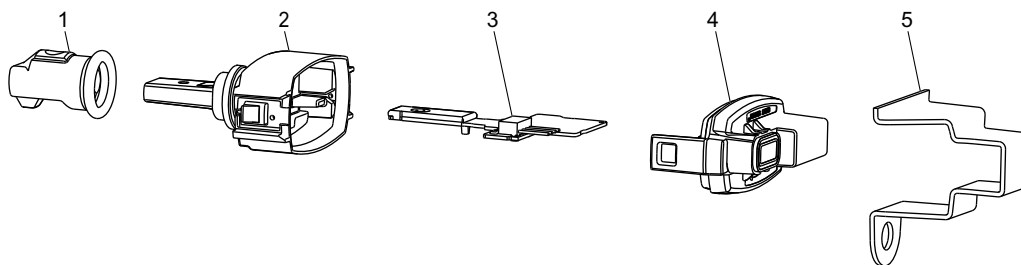

Fig. 37 Sensor

TM05 3035 0812

Pos.	Component	Material	EN
1	Sealing cap	EPDM	
2	Housing	PPS	
3	Printed-circuit board	-	
4	Cover snap-on	PA/TPV	
5	Bracket for sensor	Stainless steel	

6. Installation

Mechanical installation

The MAGNA3 is designed for indoor installation. The pump must be installed with horizontal motor shaft.

The pump may be installed in horizontal as well as vertical pipes.



TM05 2866 0712

Fig. 38 Installation positions

Arrows on the pump housing indicate the liquid flow direction through the pump.

The control box must be in horizontal position with the Grundfos logo in vertical position. See fig. 38.

This is described in the installation and operating instructions.



<http://GRUNDFOS.COM/MAGNA3-MANUAL>

The pump must be installed in such a way that it is not stressed by the pipework.

The pump may be suspended direct in the pipes, provided that the pipework can support the pump.

Twin-head pumps are prepared for installation on a mounting bracket or base plate.

To ensure adequate cooling of motor and electronics, the following must be observed:

- Position the pump in such a way that sufficient cooling is ensured.
- The temperature of the ambient air must not exceed +40 °C.

Insulating shells

The insulating shells supplied with single-head MAGNA3 pumps are for heating systems and should be fitted as part of the installation.

Insulating shells for air-conditioning and cooling systems are available as an accessory.

See section *Insulating kits for air-conditioning and cooling systems*, page 36.

Note: Insulating shells are not available for twin-head pumps.

Electrical installation

The electrical connection and protection should be carried out in accordance with local regulations.

- The pump must be connected to an external mains switch.
- The pump must always be correctly earthed.
- The pump requires no external motor protection.
- The pump incorporates thermal protection against slow overloading and blocking.
- When switched on via the power supply, the pump will start pumping after approx. 5 seconds.

Note: The number of starts and stops via the power supply must not exceed four times per hour.

The pump has a digital input that can be used for external control of start/stop without switching the power supply on/off.

The pump mains connection must be made as shown in the diagrams on the following pages.

Cables

Use screened cables for external on/off switch, digital input, sensor and setpoint signals.

- All cables used must be heat-resistant up to at least +85 °C.
- All cables used must be installed in accordance with EN 60204-1 and EN 50174-2:2000.

Additional protection

If the pump is connected to an electric installation where an earth leakage circuit breaker (ELCB) is used as an additional protection, this circuit breaker must trip when earth fault currents with DC content (pulsating DC) occur.

The earth leakage circuit breaker must be marked with the first or both of the symbols shown below:



Symbol	Description
	High-sensitivity ELCB, type A, according to IEC 60775
	High-sensitivity ELCB, type B, according to IEC 60775

Examples of connections

Supply connection

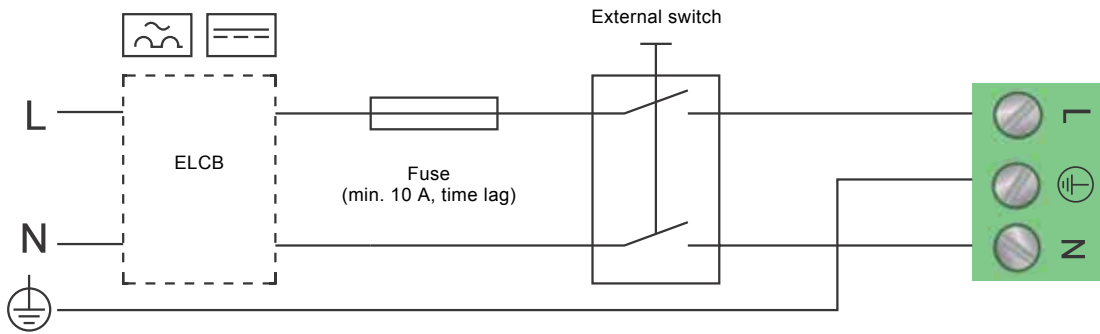

Fig. 39 Example of typical connection, 1 x 230 V ± 10 %, 50/60 Hz

As a minimum, a 10 A time-lag fuse must be installed due to the start-up power of the MAGNA3.

Connection to external controllers

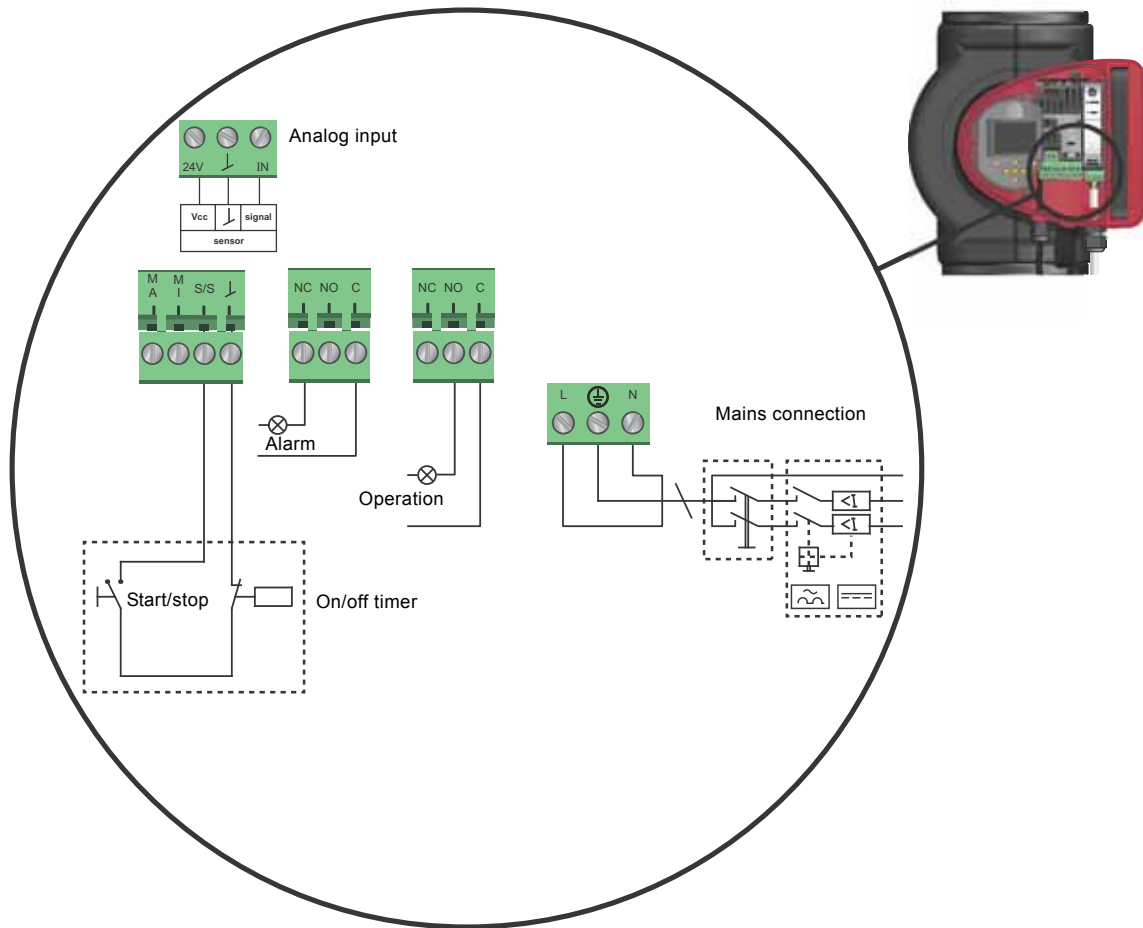

Fig. 40 Example of connections in the control box

TM03 2397 0312

TM05 2673 3812

Digital inputs

The digital input can be used for external control of start/stop or forced max. or min. curve.

Note: If no external on/off switch is connected, the jumper between terminals Start/Stop (S/S) and frame (\perp) should be maintained. This connection is the factory setting.

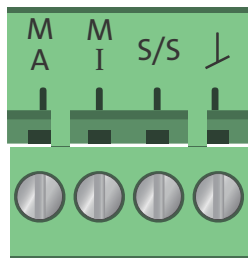

Fig. 41 Digital input in control box

Contact symbol	Function
M A	Max. curve
M I	Min. curve
S/S	Start/Stop
\perp	Frame connection

TM05 3343 1212

External start/stop

The pump can be started or stopped via the digital input.

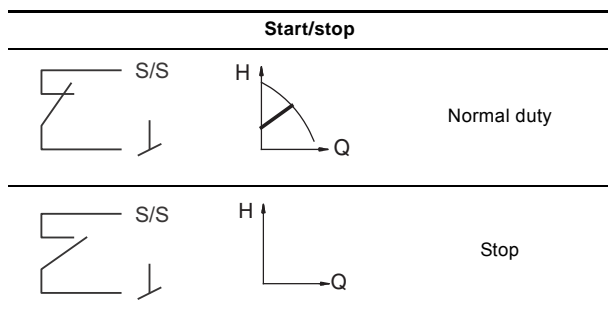

External forced max. or min curve

The pump can be forced to operate on the max. or min. curve via the digital input.

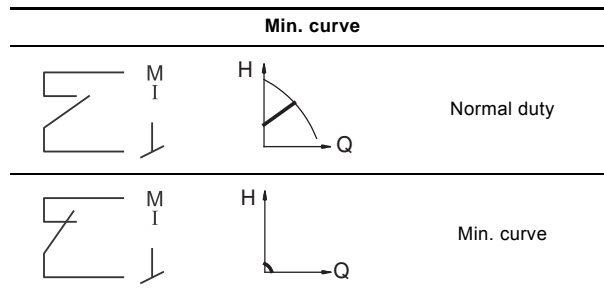
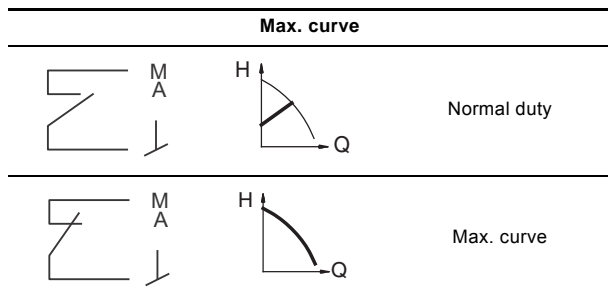

Relay outputs

The pump has two signal relays with a potential-free changeover contact for external fault indication.

The function of the signal relay can be set to "Alarm", "Ready" or "Operation" on the pump control panel or with the Grundfos GO Remote.

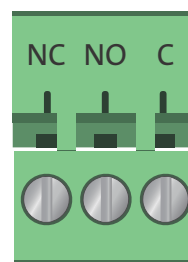

Fig. 42 Relay output in control box

Contact symbol	Function
NC	Normally closed
NO	Normally open
C	Common

TM05 3343 1212

The functions of the signal relays are as shown in the table below:

Signal relay	Alarm signal
	<p>Not activated:</p> <ul style="list-style-type: none"> The power supply has been switched off. The pump has not registered a fault.
	<p>Activated:</p> <ul style="list-style-type: none"> The pump has registered a fault.
Signal relay	Ready signal
	<p>Not activated:</p> <ul style="list-style-type: none"> The pump has registered a fault and is unable to run.
	<p>Activated:</p> <ul style="list-style-type: none"> The pump has been set to stop, but is ready to run. The pump is running.
Signal relay	Operating signal
	<p>Not activated:</p> <ul style="list-style-type: none"> The pump is not running.
	<p>Activated:</p> <ul style="list-style-type: none"> The pump is running.

Analog input for external sensor

The analog input can be used for the connection of an external sensor for measuring temperature, pressure, flow or other parameter.

The analog input can also be used for an external signal for the control from a BMS system or similar control system.

The electrical signal for the input can be 0-10 VDC or 4-20 mA.

The selection of electrical signal (0-10 V or 4-20 mA) can be changed on the control panel or with the Grundfos GO Remote.

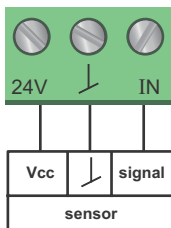
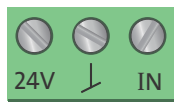

Fig. 43 Analog input for external sensor or control

In order to optimise the pump performance, external sensors can advantageously be used in the following cases:

Function/control mode	Sensor type
Heat energy meter	Temperature sensor
Constant temperature	Temperature sensor
Proportional pressure	Pressure sensor

Max.
24 V DC
22 mA



Vcc ↓ Signal

0-10 V DC



4-20 mA

Vcc ↓ Signal

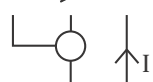

Fig. 44 Wiring, analog input

TM05 3221 1112

TM05 3343 1212

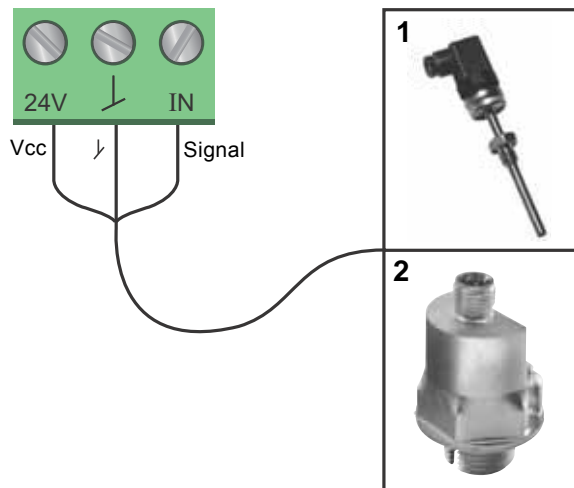

Fig. 45 Examples of external sensors

Pos.	Sensor type
1	Temperature transmitter, Danfoss type MBT 3560, 1/2" connection and 4-20 mA signal.
2	Pressure transmitter, Grundfos type RPI. 1/2" connection and 4-20 mA signal.

For further details, see section *External sensors*, page 45.

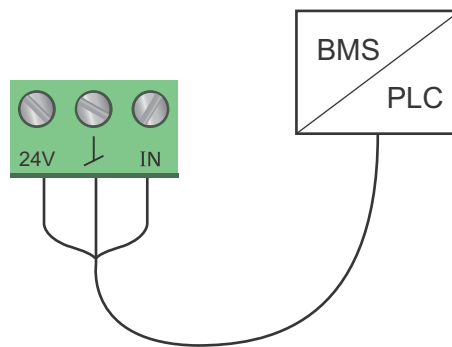

Fig. 46 Example of external signal for the control via BMS or PLC

TM05 2947 1212

TM05 2888 0612

7. Accessories

Insulating kits for air-conditioning and cooling systems

Single-head MAGNA3 pumps for air-conditioning and cooling systems can be fitted with insulating shells. A kit consists of two shells made of polyurethane (PUR) and a self-adhesive seal to ensure tight assembly.



TM05 2874 0412

Fig. 47 Fitting the insulating shells to a MAGNA3 pump

Note: The dimensions of the insulating shells for air-conditioning and cooling systems differ from those of the insulating shells for heating systems. The insulating shells can be used for both stainless-steel and cast-iron pumps.

Pump type	Product number
MAGNA3 32-120 F	98063287
MAGNA3 40-80/100 F	98063288
MAGNA3 40-120/150/180 F	98145675
MAGNA3 50-40/60/80 F	98063289
MAGNA3 50-100/120/150/180 F	98145676
MAGNA3 65-40/60/80/100/120/150 F	96913593
MAGNA3 80-40/60/80/100/120 F	98134265
MAGNA3 100-40/60/80/100/120 F	96913589

Note: Insulating shells for single-head pumps for heating systems are supplied with the pump. The insulating shells cannot be ordered as accessories.

CIM modules

A CIM module is an add-on Communication Interface Module. The CIM module enables data transmission between the pump and an external system, for example a BMS or SCADA system.

The CIM module communicates via fieldbus protocols. The following CIM modules are available:

Module	Fieldbus protocol	Product number
CIM 050	GENIbus	96824631
CIM 100	LonWorks	96824797
CIM 150	Profibus DP	96824793
CIM 200	Modbus RTU	96824796
CIM 270	GRM	96898815
CIM 300	BACnet MS/TP	96893770

For further information about data communication via CIM modules, see the CIM documentation available in WebCAPS.

Location of CIM module

The CIM module is fitted behind the front cover. See fig. 48.

For installation, see separate installation and operating instructions.



<http://GRUNDFOS.COM/MAGNA3-MANUAL>

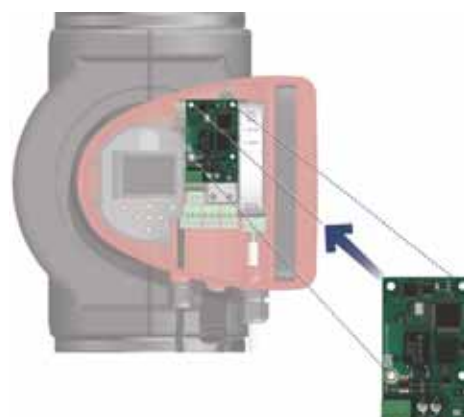

TM05 2914 1112

Fig. 48 Location of CIM module

Reuse of CIM modules

A CIM module in a CIU unit used together with Grundfos MAGNA can be reused in MAGNA3. The CIM module has to be re-configured before it is used in a MAGNA3 pump. Contact your nearest Grundfos company.



TM05 2911 1312

Fig. 49 Reuse of CIM module

Grundfos Remote Management

Application	Description	Product number
CIM 270	Grundfos Remote Management (requires a contract with Grundfos and a SIM card).	96898815
GSM antenna for roof-mounting	Antenna for use on top of metal cabinets. Vandal-proof. 2-metre cable. Quad band (global use).	97631956
GSM antenna for desk-mounting	Antenna for general-purpose application, for example inside plastic cabinets. To be fixed with the double-adhesive tape supplied. 4-metre cable. Quad band (global use).	97631957

For GRM contract, please contact your local Grundfos company.

Grundfos GO Remote

The pump is designed for wireless communication with the Grundfos GO Remote app which communicates with the pump via radio communication.

Note: The radio communication between the pump and the Grundfos GO Remote is encrypted to protect against misuse.

The Grundfos GO Remote app is available from Apple App Store and Android market.

The Grundfos GO Remote app must be used in conjunction with one of the following Mobile Interface devices:

Mobile interface	Product number
Grundfos MI 201	98140638
Grundfos MI 202	98046376
Grundfos MI 301	98046408

The Grundfos GO Remote concept replaces the Grundfos R100 remote control. This means that all products supported by the R100 are supported by the Grundfos GO Remote.

For function and connection to the pump, see separate installation and operating instructions for the desired type of Grundfos GO Remote setup.

Mobile interface

The three mobile interface devices are described in the following.

MI 201

The MI 201 is a complete solution, consisting of an Apple iPod touch 4G and a Grundfos cover for infrared and radio communication with Grundfos pumps or systems.



Fig. 50 MI 201

Supplied with the product:

- Apple iPod touch 4G incl. accessories
- Grundfos MI 201 cover
- battery charger
- quick guide.

TM05 3886 1612

MI 202

The MI 202 is an add-on module with built-in infrared and radio communication. The MI 202 can be used in conjunction with Apple iPod touch 4G, iPhone 4G or later.



Fig. 51 MI 202

Supplied with the product:

- Grundfos MI 202
- quick guide.

MI 301

The MI 301 is a module with built-in infrared and radio communication. The MI 301 must be used in conjunction with an Android or iOS-based Smartphone with a Bluetooth connection. The MI 301 has a rechargeable Li-ion battery that must be charged separately.



Fig. 52 MI 301

Supplied with the product:

- Grundfos MI 301
- battery charger
- quick guide.

Supported units

Make	Model	Operating system	MI 201	MI 202	MI 301
Apple	iPod touch 4G	iOS 5.0 or later	•	•	•
	iPhone 4G, 4GS		-	•	•
HTC	Desire S	Android 2.3.3 or later	-	-	•
	Sensation	Android 2.3.4 or later	-	-	•
Samsung	Galaxy S II		-	-	•

Note: Similar Android and iOS-based devices may work as well, but are not supported by Grundfos.

TM05 3887 1612

TM05 3887 1612

Counter flanges

Cast-iron pumps

A counter-flange kit consists of two stainless-steel flanges, two gaskets of asbestos-free material IT 200 and the required number of bolts and nuts.

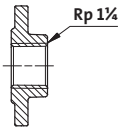
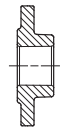
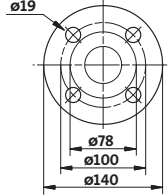
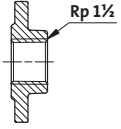
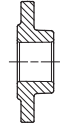
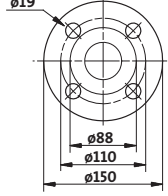
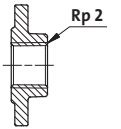
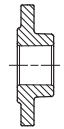
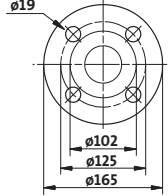
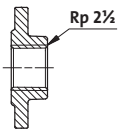
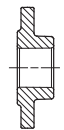
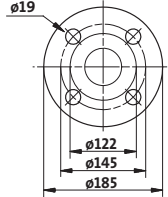
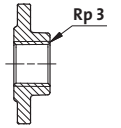
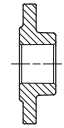
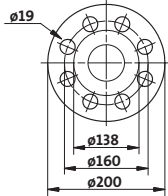
Counter flange			Pump type	Description	Rated pressure (EN 1092-2)	Pipework connection	Product number
 Threaded	 For welding	 TM03 0478 5204	MAGNA3 DN 32	Threaded	10 bar	Rp 1 1/4	539703
				For welding	10 bar	32 mm, nominal	539704
				Threaded	16 bar	Rp 1 1/4	539703
				For welding	16 bar	32 mm, nominal	539704
				Threaded	10 bar	Rp 1 1/2	539701
				For welding	10 bar	40 mm, nominal	539702
 Threaded	 For welding	 TM03 0479 5204	MAGNA3 DN 40	Threaded	16 bar	Rp 1 1/2	539701
				For welding	16 bar	40 mm, nominal	539702
				Threaded	10 bar	Rp 2	549801
				For welding	10 bar	50 mm, nominal	549802
 Threaded	 For welding	 TM03 0480 5204	MAGNA3 DN 50	Threaded	16 bar	Rp 2	549801
				For welding	16 bar	50 mm, nominal	549802
				Threaded	10 bar	Rp 2 1/2	559801
				For welding	10 bar	65 mm, nominal	559802
 Threaded	 For welding	 TM03 0481 5204	MAGNA3 DN 65	Threaded	16 bar	Rp 2 1/2	559801
				For welding	16 bar	65 mm, nominal	559802
				Threaded	6 bar	Rp 3	569902
				For welding	6 bar	80 mm, nominal	569901
 Threaded	 For welding	 TM03 0482 5204	MAGNA3 DN 80	Threaded	10 bar	Rp 3	569802
				For welding	10 bar	80 mm, nominal	569801
				Threaded	16 bar	Rp 3	569802
				For welding	16 bar	80 mm, nominal	569801

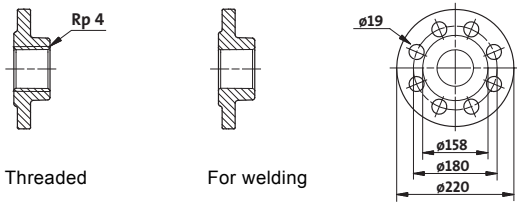
Counter flange	Pump type	Description	Rated pressure (EN 1092-2)	Pipework connection	Product number
 <p>Threaded</p> <p>For welding</p> <p>TM03 0483 5204</p> <p>MAGNA3 DN 100</p>		Threaded	6 bar	Rp 4	579901
		For welding	6 bar	100 mm, nominal	579902
		Threaded	10 bar	Rp 4	579801
		For welding	10 bar	100 mm, nominal	579802
		Threaded	16 bar	Rp 4	579801
		For welding	16 bar	100 mm, nominal	579802

Stainless-steel pumps



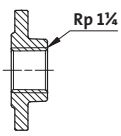
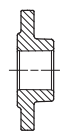
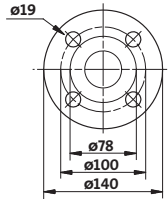
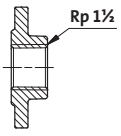
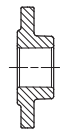
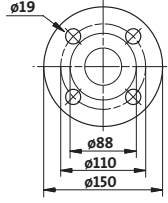
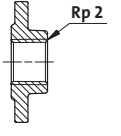
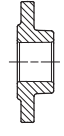
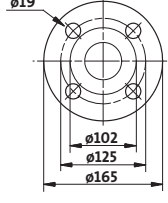
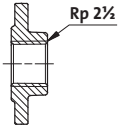
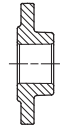
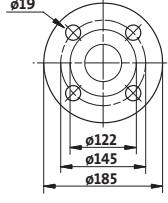
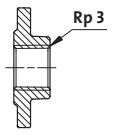
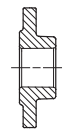
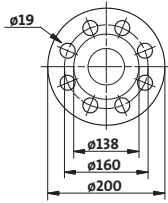
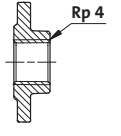
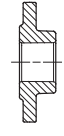
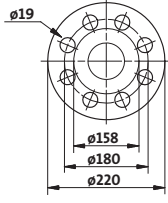

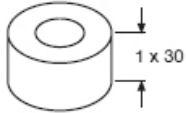
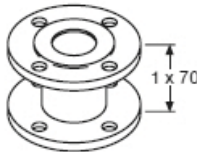
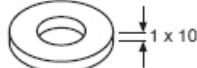
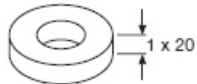
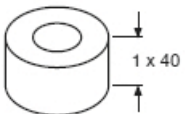
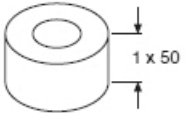
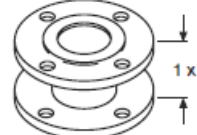

A counter-flange kit consists of two bronze flanges, two gaskets of asbestos-free material IT 200 and the required number of bolts and nuts.

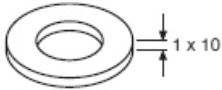
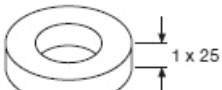
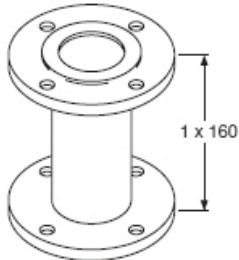
Counter flange	Pump type	Description	Rated pressure (EN 1092-2)	Pipework connection	Product number		
 <p>Threaded</p>	 <p>For welding</p>	 <p>TM03 0478 5204</p>	<p>MAGNA3 DN 32</p>	Threaded	10 bar	Rp 1 1/4	96427029
				For welding	10 bar	32 mm, nominal	96427030
				Threaded	16 bar	Rp 1 1/4	96427029
				For welding	16 bar	32 mm, nominal	96427030
 <p>Threaded</p>	 <p>For welding</p>	 <p>TM03 0479 5204</p>	<p>MAGNA3 DN 40</p>	Threaded	10 bar	Rp 1 1/2	539711
				For welding	10 bar	40 mm, nominal	539712
				Threaded	16 bar	Rp 1 1/2	539711
				For welding	16 bar	40 mm, nominal	539712
 <p>Threaded</p>	 <p>For welding</p>	 <p>TM03 0480 5204</p>	<p>MAGNA3 DN 50</p>	Threaded	10 bar	Rp 2	549811
				For welding	10 bar	50 mm, nominal	549812
 <p>Threaded</p>	 <p>For welding</p>	 <p>TM03 0481 5204</p>	<p>MAGNA3 DN 65</p>	Threaded	10 bar	Rp 2 1/2	559811
				For welding	10 bar	65 mm, nominal	559812
 <p>Threaded</p>	 <p>For welding</p>	 <p>TM03 0482 5204</p>	<p>MAGNA3 DN 80</p>	Threaded	6 bar	Rp 3	96405735
				For welding	6 bar	80 mm, nominal	569911
				Threaded	10 bar	Rp 3	569812
				For welding	10 bar	80 mm, nominal	569811
 <p>Threaded</p>	 <p>For welding</p>	 <p>TM03 0485 5204</p>	<p>MAGNA3 DN 100</p>	Threaded	6 bar	Rp 4	96405737
				Threaded	10 bar	Rp 4	96405738

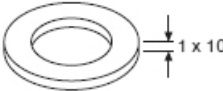
Adapter for various port-to-port lengths

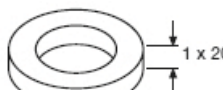
DN	Type	Height [mm]	Diameter [mm]		Pitch circle diameter [mm]			Product number		
			PN 6	PN 10	PN 6	PN 10		PN 6	PN 10	
40	A40-30	1 x 30	-	-	-	-		TM05 4372 2212	96281076	96608515
	A40-70	1 x 70	-	-	100	110		TM05 4373 2212	539921	539721
	A50-10	1 x 10	90	102	-	125		TM05 4374 2212	549921	549821
	A50-20	1 x 20	90	102	-	-		TM05 4375 2212	549922	549822
50	A50-40	1 x 40	-	-	-	-		TM05 4376 2212	96281077	96608516
	A50-50	1 x 50	90	102	-	-		TM05 4377 2212	549923	549823
	A50-60	1 x 60	-	-	110	125		TM05 4378 2212	549924	549824

DN	Type	Height [mm]	Diameter [mm]		Pitch circle diameter [mm]			Product number		
			PN 6	PN 10	PN 6	PN 10		PN 6	PN 10	
	A65-10	1 x 10	110	122	-	-		TM05 4379 2212	559921	559821
65	A65-25	1 x 25	110	122	-	-		TM05 4380 2212	559922	559822
	A65-160	1 x 160	-	-	130	145		TM05 4381 2212	559923	559823

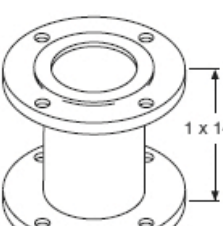
DN	Type	Height [mm]	Diameter [mm]		Pitch circle diameter [mm]			Product number		
			PN 6	PN 10	PN 6	PN 10		PN 6	PN 10	
80	A80-10	1 x 10	127	138	150	160		TM05 4382 2212	569921	569821
	A80-15	1 x 15	127	138	-	-		TM05 4383 2212	569922	569822
	A80-20	1 x 20	127	138	-	-		TM05 4384 2212	569923	569823
	A80-25	1 x 25	127	138	-	-		TM05 4385 2212	569924	569824
	A80-40	1 x 40	127	138	-	-		TM05 4386 2212	569925	569825
	A80-50	1 x 50	127	138	-	-		TM05 4387 2212	569926	569826
	A80-140	1 x 140	-	-	150	160		TM05 4388 2212	569927	569827

DN	Type	Height [mm]	Diameter [mm]		Pitch circle diameter [mm]		Product number	
			PN 6	PN 10	PN 6	PN 10	PN 6	PN 10
100	A100-50	2 x 25	-	-	-	-	96545610	96545610

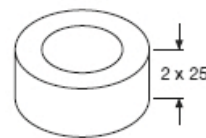

TM05 4389 2212

External sensors

Sensor	Type	Supplier	Measuring range [°C]	Transmitter output [mA]	Pocket insertion length [mm]	Process connection	Protection tube [mm]	Product number
Temperature transmitter	MBT 3560	Danfoss	-50 to +150	4-20	37.5	G 1/2 A	∅11	98355521

Sensor	Type	Supplier	Measuring range [bar]	Transmitter output [mA]	Power supply [VDC]	Process connection	Product number
Pressure transmitter	RPI	Grundfos	0 - 0.6	4-20	12-30	G 1/2	97748907
			0 - 1.0				97748908
			0 - 1.6				97748909
			0 - 2.5				97748910
			0 - 4.0				97748921
			0 - 6.0				97748922
			0 - 12				97748923
0 - 16	97748924						

Blanking flange

A blanking flange is used to blank off the opening when one of the pumps of a twin-head pump is removed for service to enable uninterrupted operation of the other pump.

Blanking flange	Product number
All pumps	98159372

8. Curve conditions

Performance curves

The guidelines below apply to the performance curves on pages 48 to 105:

- Test liquid: airless water.
- The curves apply to a density of $\rho = 983.2 \text{ kg/m}^3$ and a liquid temperature of $+60 \text{ }^\circ\text{C}$.
- All curves show average values and should not be used as guarantee curves. If a specific minimum performance is required, individual measurements must be made.
- The curves apply to a kinematic viscosity of $\nu = 0.474 \text{ mm}^2/\text{s}$ (0.474 cSt).
- Reference supply voltage: 1 x 230 V, 50 Hz.
- EEI obtained according to EN 16297.

Note: Within the MAGNA3 performance range, the constant- and proportional-pressure curves can be set in steps of 0.1 m head on the control panel or with the Grundfos GO Remote.

Symbols used on the following pages



Fig. 53 Energy efficiency index (EEI)

The MAGNA3 is energy-optimised and complies with the EuP Directive (Commission Regulation (EC) No 641/2009) which will be effective as from 1 January 2013.

For MAGNA3 pumps, the average energy efficiency index (EEI) is 0.18 with values down to 0.17, categorised as best in class.

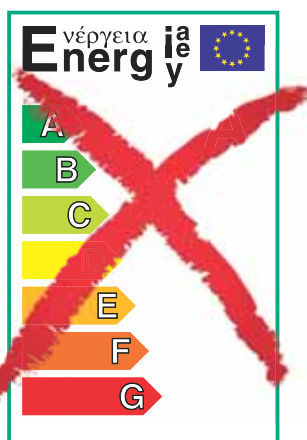

Fig. 54 Old energy label

From 1 January 2013, the old A to G energy label will be replaced by the new energy efficiency index (EEI). Only the best of today's A-labelled circulator pumps will meet the new requirements.

The MAGNA3 with its AUTO_{ADAPT} function is the preferred choice for large heating systems and a true efficiency frontrunner.

Figure 55 shows the energy consumption index for a typical circulator pump compared to the various EEI limits.

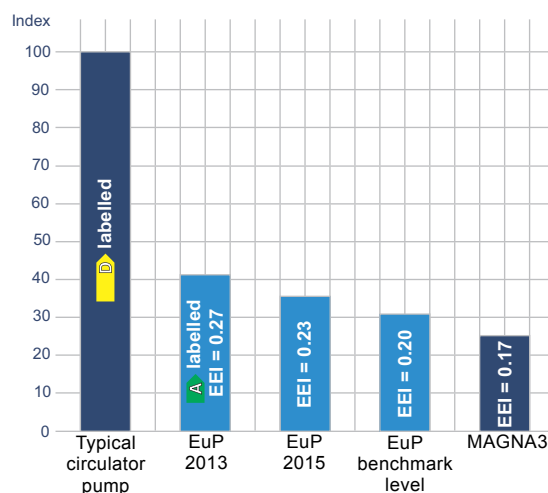

Fig. 55 Energy consumption index

With an energy efficiency index (EEI) well below the EuP benchmark level, you can achieve energy savings of up to 75 % compared to a typical circulator pump and thus a remarkably fast return on investment. This means, of course, that the MAGNA3 more than meets the standards of the EuP legislation.

For more information about the new energy directive, please visit:



<http://energy.Grundfos.com>



Fig. 56 Grundfos blueflux®

The Grundfos blueflux® label is your guarantee that the MAGNA3 incorporates the most energy-efficient motor currently available. Grundfos blueflux® motors are designed to cut the power consumption by up to 60 % and thus reduce CO₂ emissions and operating costs.

QR code on pump nameplate



Fig. 57 QR code on pump nameplate

With the Grundfos GO Remote or a smartphone, it is possible to get the following information about the MAGNA3:

- product photo
- pump performance curves
- dimensional sketches
- wiring diagram
- quotation text
- technical data
- service parts list
- PDF files, such as data booklet and installation and operating instructions.

Markings

The following marks are available after positive testing of MAGNA3:

Mark	Description
	The EC marking is based on the declaration of conformity issued by the manufacturer who certifies that the product meets all the appropriate provisions of the relevant legislation implementing certain European Directives.
	Technical working equipment and commodities ready for use, in the sense of ProdSG according to German VDE/EN/IEC standards, other technical specifications as well as possible provisions of law with respect to safety and health requirements.
	The GOST R certification ensures that the delivered product has successfully passed a certification process and that it complies with Russian legislation.
	The product complies with the requirements of the United Kingdom Water Supply (Water Fittings) Regulations/Scottish Water Byelaws. Applies to the stainless-steel version only.

TM05 2683 0412

TM05 3826 1712

9. Performance curves and technical data

MAGNA3 32-120 F (N)

1 x 230 V, 50/60 Hz

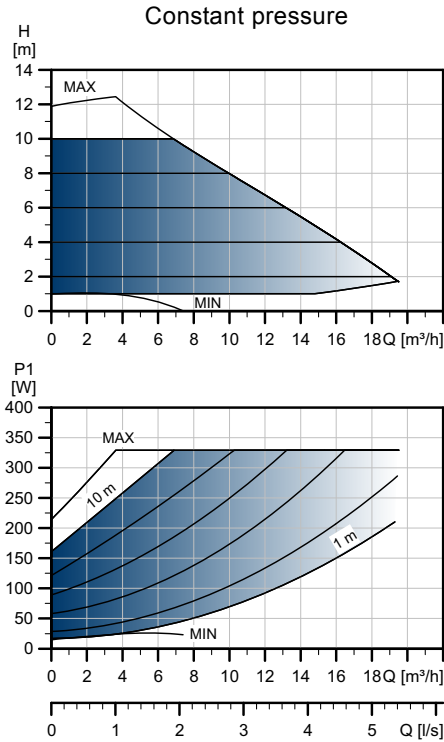
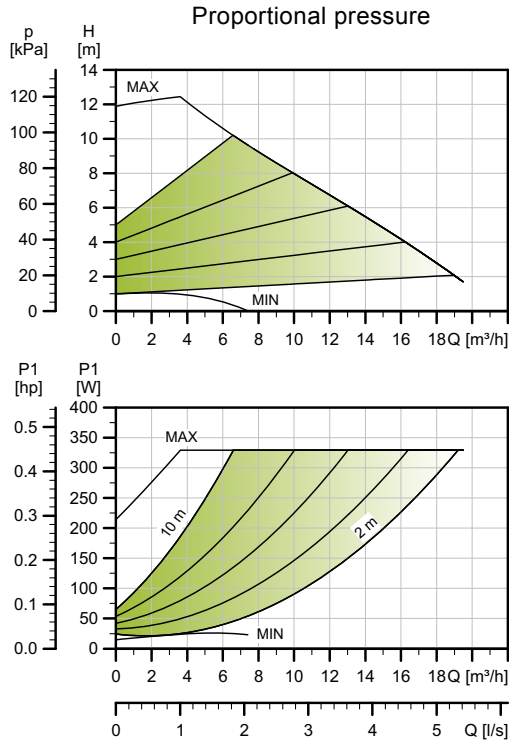

TM05 3733 1912

Speed	P1 [W]	I _{1/1} [A]
Min.	15	0.18
Max.	336	1.50

The pump incorporates overload protection.

Net weights [kg]	Gross weights [kg]	Ship. vol. [m ³]
15	17.4	0.04

Connections: See *Counter flanges*, page 39.
 System pressure: Max. 1.0 MPa (10 bar). Also available as max. 1.6 MPa (16 bar).
 Liquid temperature: -10 °C to +110 °C (TF 110).
 Also available with: Stainless-steel pump housing, type N.
 Specific EEI: 0.18.

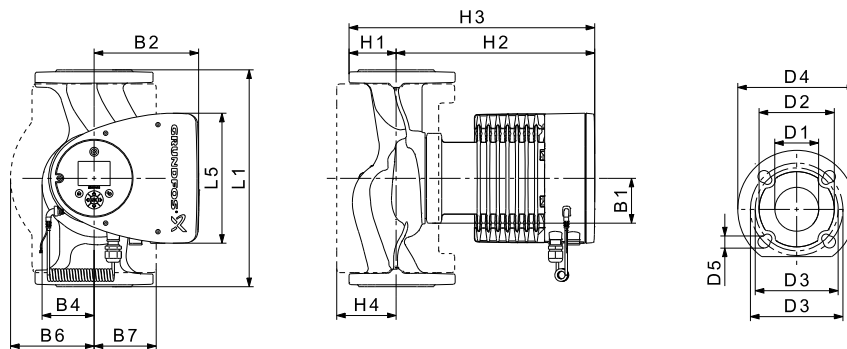

TM05 2204 3612

Pump type	Dimensions [mm]															
	L1	L5	B1	B2	B4	B6	B7	H1	H2	H3	H4	D1	D2	D3	D4	D5
MAGNA3 32-120 F (N)	220	204	84	164	73	106	116	65	301	366	86	32	76	90/100	140	14/19

For product numbers, see page 106.

MAGNA3 D 32-120 F

1 x 230 V, 50/60 Hz

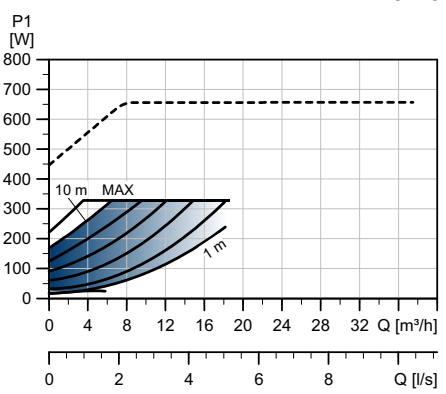
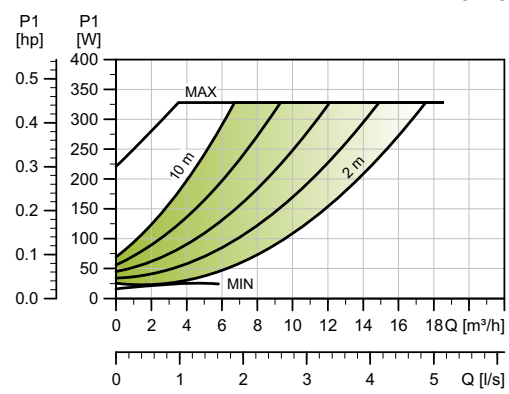
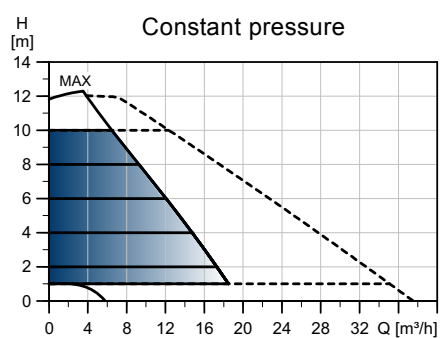
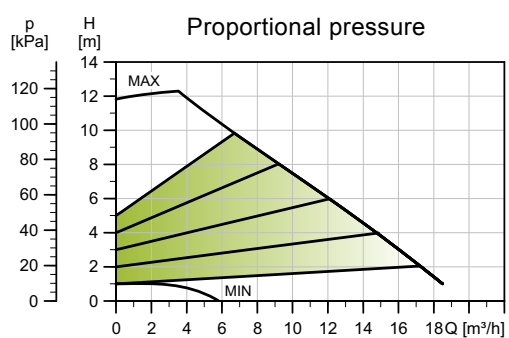

TM05 3787 1912

Speed	P1 [W]	I _{1/1} [A]
Min.	16	0.18
Max.	335	1.49

The pump incorporates overload protection.

Connections: See Counter flanges, page 39.
 System pressure: Max. 1.0 MPa (10 bar). Also available as max. 1.6 MPa (16 bar).
 Liquid temperature: -10 °C to +110 °C (TF 110).
 Specific EEI: 0.20.

Net weights [kg]	Gross weights [kg]	Ship. vol. [m ³]
30	30.3	0.04

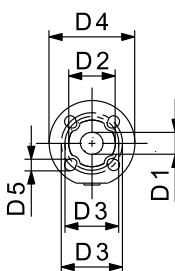
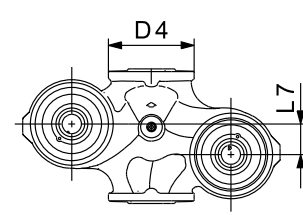
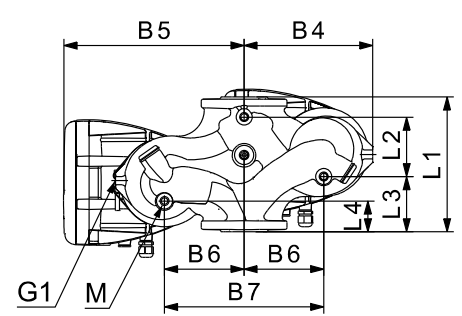
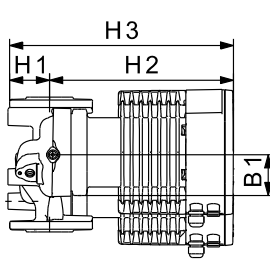
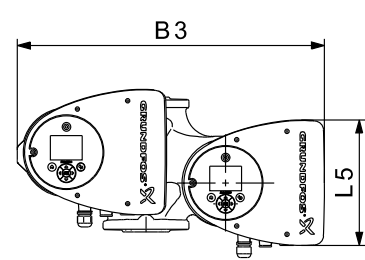

TM05 5294 3612

Pump type	Dimensions [mm]																					
	L1	L2	L3	L4	L5	L7	B1	B3	B4	B5	B6	B7	H1	H2	H3	D1	D2	D3	D4	D5	M	M1
MAGNA3 D 32-120 F	220	97	90	50	204	50	84	502	210	294	130	260	68	300	368	32	76	90/100	140	14/19	M12	Rp 1/4

For product numbers, see page 106.

MAGNA3 40-80 F (N)

1 x 230 V, 50/60 Hz

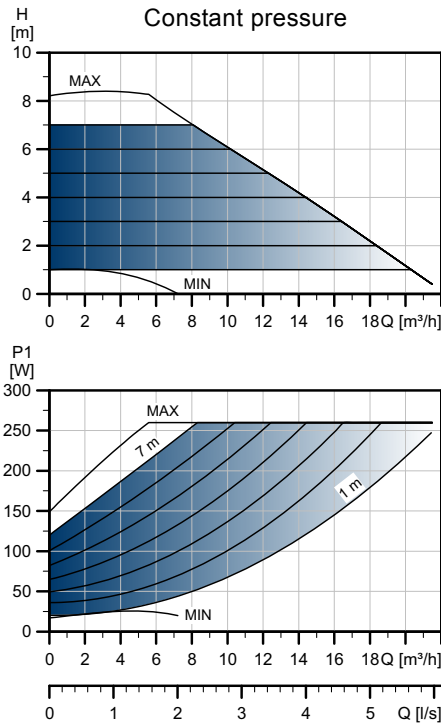
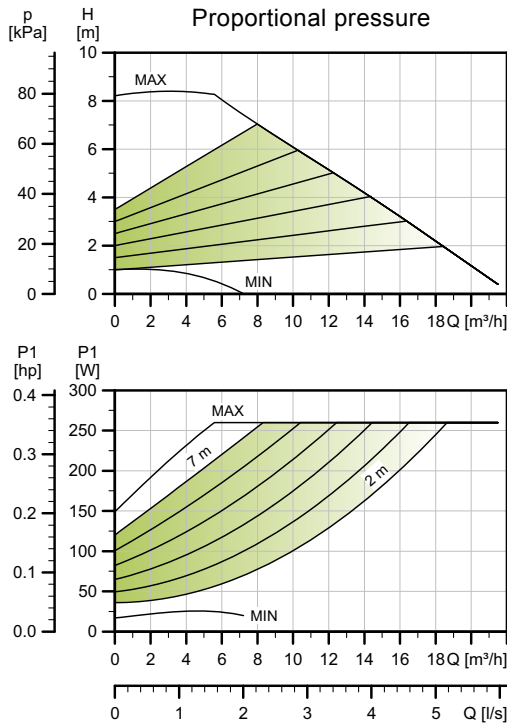

TM05 3734 1912

Speed	P1 [W]	I _{1/I1} [A]
Min.	17	0.19
Max.	265	1.20

The pump incorporates overload protection.

Net weights [kg]	Gross weights [kg]	Ship. vol. [m ³]
15.9	18.7	0.04

Connections: See *Counter flanges*, page 39.
 System pressure: Max. 1.0 MPa (10 bar). Also available as max. 1.6 MPa (16 bar).
 Liquid temperature: -10 °C to +110 °C (TF 110).
 Also available with: Stainless-steel pump housing, type N.
 Specific EEI: 0.19.

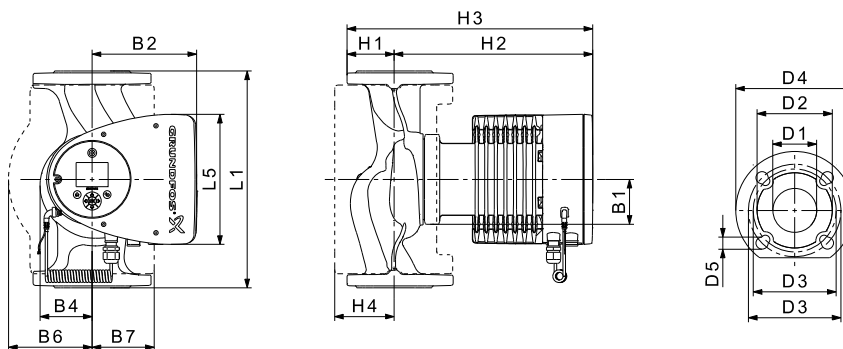

TM05 2204 3612

Pump type	Dimensions [mm]															
	L1	L5	B1	B2	B4	B6	B7	H1	H2	H3	H4	D1	D2	D3	D4	D5
MAGNA3 40-80 F (N)	220	204	84	164	73	106	128	65	304	369	83	40	84	100/110	150	14/19

For product numbers, see page 106.

MAGNA3 D 40-80 F

1 x 230 V, 50/60 Hz

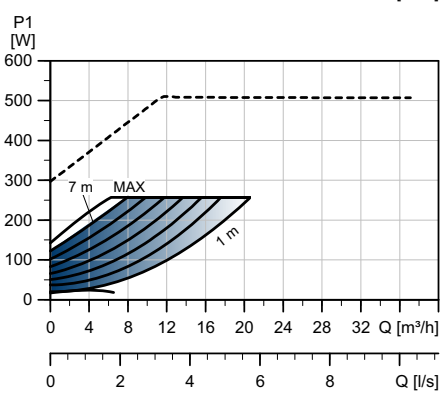
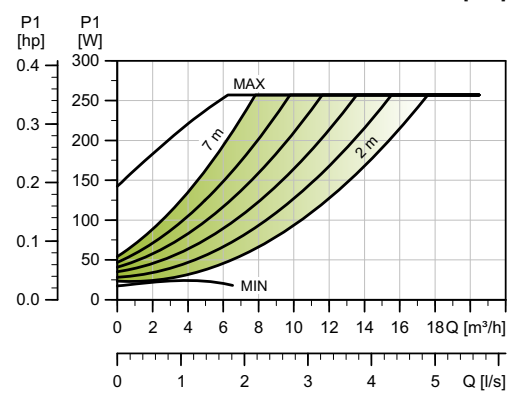
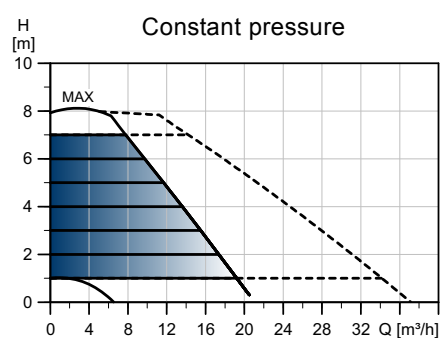
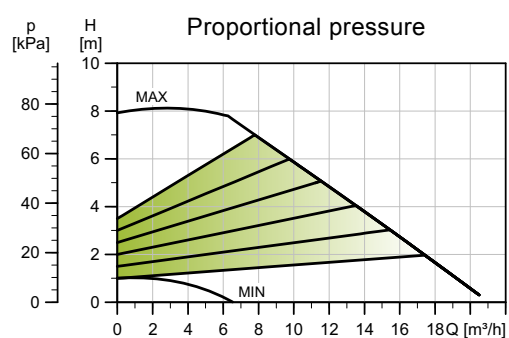

TM05 3788 1912

Speed	P1 [W]	I _{1/1} [A]
Min.	17	0.19
Max.	269	1.21

The pump incorporates overload protection.

Connections: See Counter flanges, page 39.
 System pressure: Max. 1.0 MPa (10 bar). Also available as max. 1.6 MPa (16 bar).
 Liquid temperature: -10 °C to +110 °C (TF 110).
 Specific EEI: 0.20.

Net weights [kg]	Gross weights [kg]	Ship. vol. [m ³]
32.6	32.8	0.04

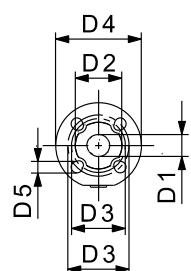
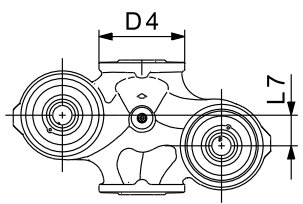
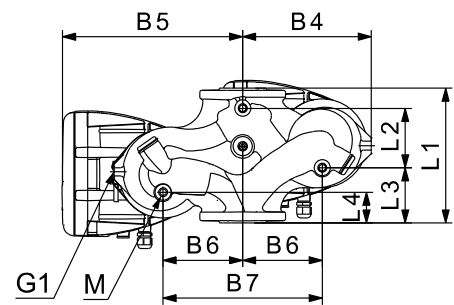
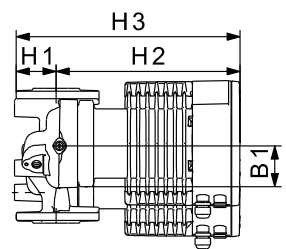
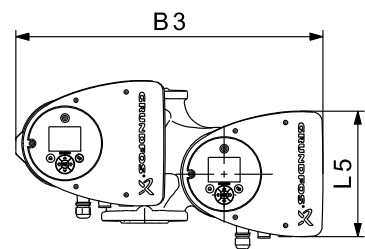

TM05 5294 3612

Pump type	Dimensions [mm]																					
	L1	L2	L3	L4	L5	L7	B1	B3	B4	B5	B6	B7	H1	H2	H3	D1	D2	D3	D4	D5	M	M1
MAGNA3 D 40-80 F	220	53	140	60	204	15	84	502	210	294	130	260	76	303	379	40	84	100/110	150	14/19	M12	Rp 1/4

For product numbers, see page 106.

MAGNA3 40-100 F (N)

1 x 230 V, 50/60 Hz

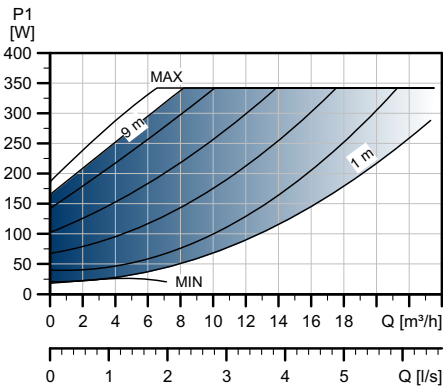
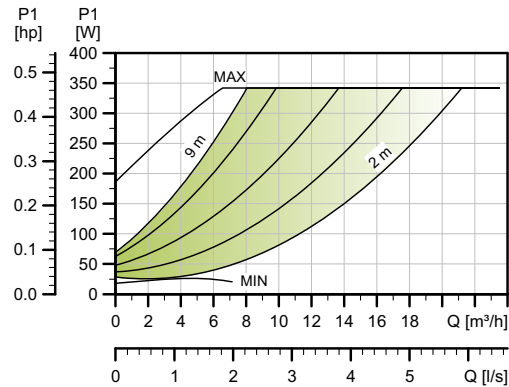
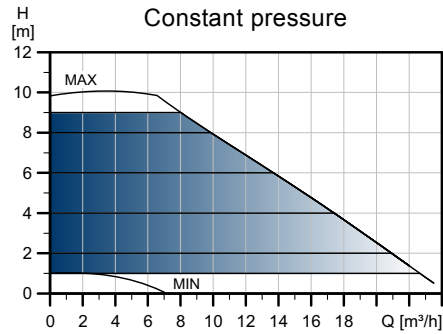
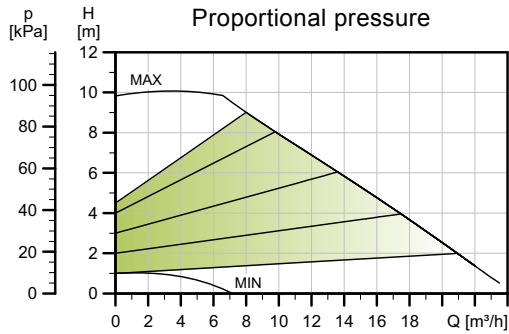

TM05 3735 1912

Speed	P1 [W]	I _{1/1} [A]
Min.	18	0.20
Max.	348	1.56

The pump incorporates overload protection.

Net weights [kg]	Gross weights [kg]	Ship. vol. [m ³]
15.9	18.7	0.04

Connections:

See *Counter flanges*, page 39.

System pressure:

Max. 1.0 MPa (10 bar).
Also available as max. 1.6 MPa (16 bar).

Liquid temperature:

-10 °C to +110 °C (TF 110).

Also available with:

Stainless-steel pump housing, type N.
0.19.

Specific EEI:

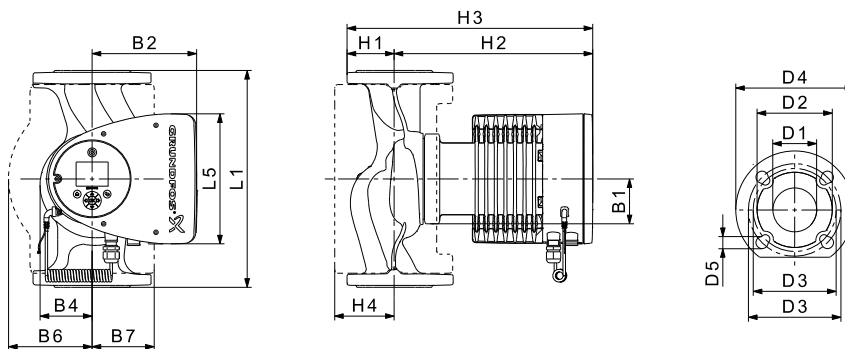

TM05 2204 3612

Pump type	Dimensions [mm]															
	L1	L5	B1	B2	B4	B6	B7	H1	H2	H3	H4	D1	D2	D3	D4	D5
MAGNA3 40-100 F (N)	220	204	84	164	73	106	128	65	304	369	83	40	84	100/110	150	14/19

For product numbers, see page 106.

MAGNA3 D 40-100 F

1 x 230 V, 50/60 Hz

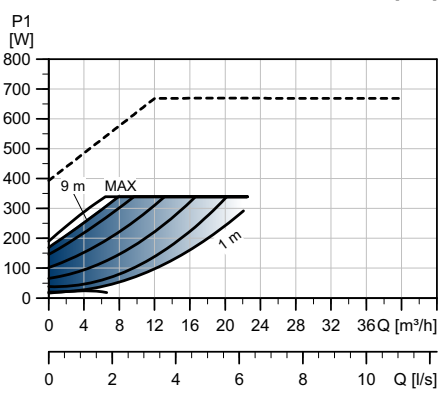
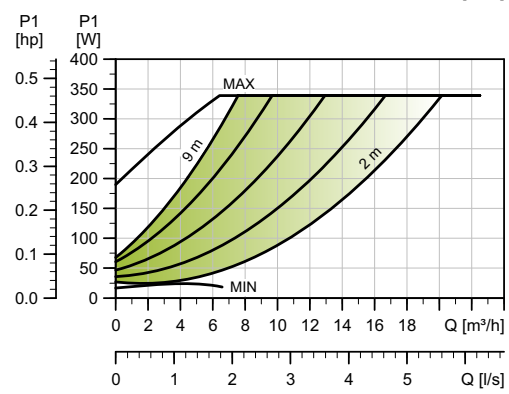
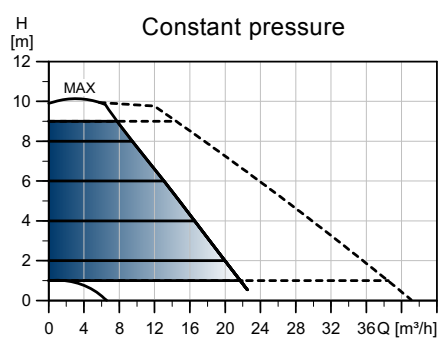
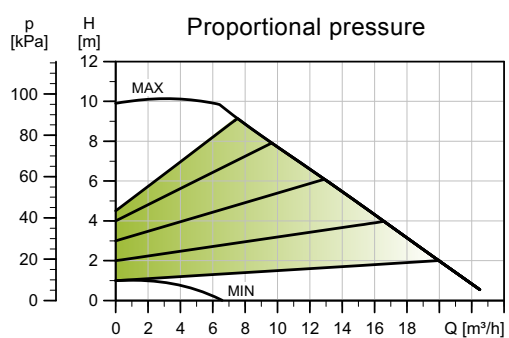

TM05 3789 1912

Speed	P1 [W]	I _{1/1} [A]
Min.	18	0.19
Max.	361	1.61

The pump incorporates overload protection.

Connections: See Counter flanges, page 39.
 System pressure: Max. 1.0 MPa (10 bar). Also available as max. 1.6 MPa (16 bar).
 Liquid temperature: -10 °C to +110 °C (TF 110).
 Specific EEI: 0.19.

Net weights [kg]	Gross weights [kg]	Ship. vol. [m ³]
32.6	32.8	0.04

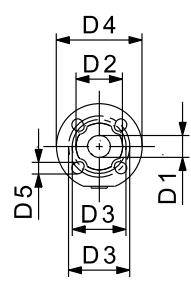
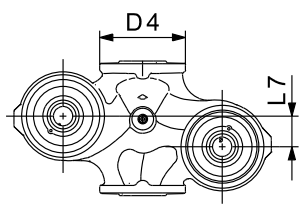
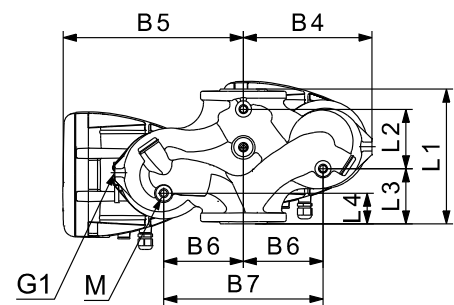
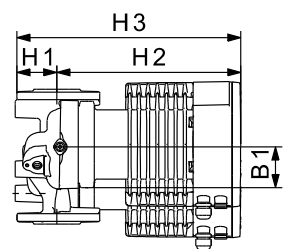
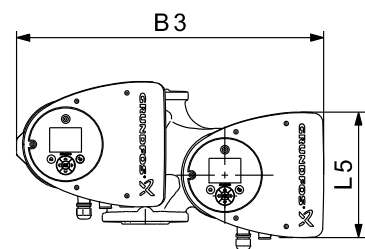

TM05 5294 3612

Pump type	Dimensions [mm]																					
	L1	L2	L3	L4	L5	L7	B1	B3	B4	B5	B6	B7	H1	H2	H3	D1	D2	D3	D4	D5	M	M1
MAGNA3 D 40-100 F	220	53	140	60	204	15	84	502	210	294	130	260	76	303	379	40	84	100/110	150	14/19	M12	Rp 1/4

For product numbers, see page 106.

MAGNA3 40-120 F (N)

1 x 230 V, 50/60 Hz

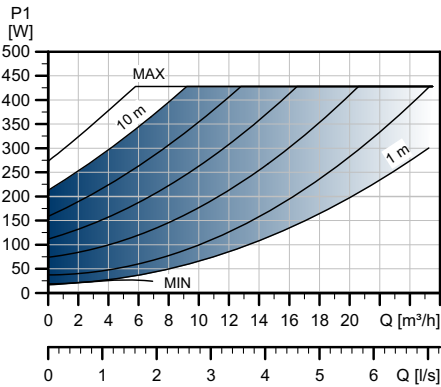
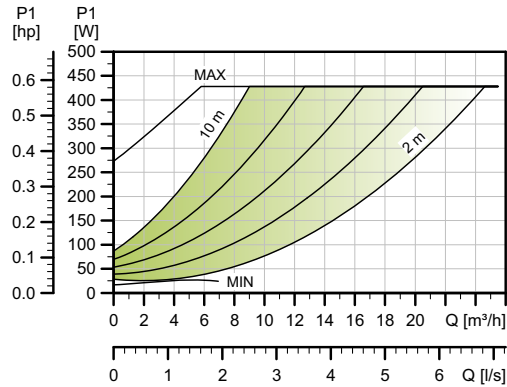
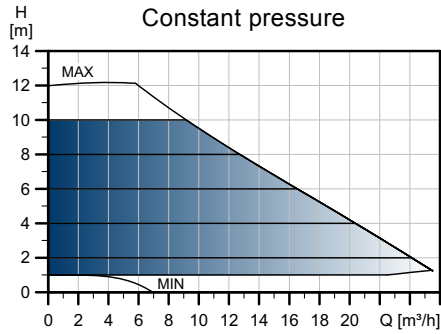
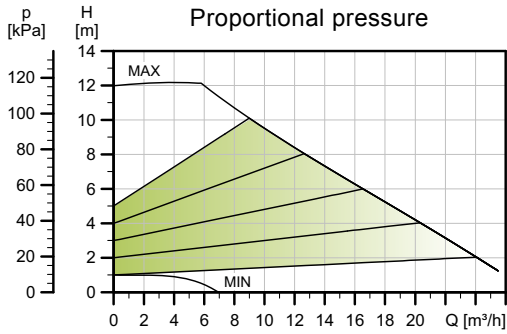

TM05 3736 1912

Speed	P1 [W]	I _{1/1} [A]
Min.	17	0.19
Max.	440	1.95

The pump incorporates overload protection.

Net weights [kg]	Gross weights [kg]	Ship. vol. [m ³]
15.5	18.2	0.04

Connections:

See *Counter flanges*, page 39.

System pressure:

Max. 1.0 MPa (10 bar).
Also available as max. 1.6 MPa (16 bar).

Liquid temperature:

-10 °C to +110 °C (TF 110).

Also available with:

Stainless-steel pump housing, type N.

Specific EEI:

0.18.

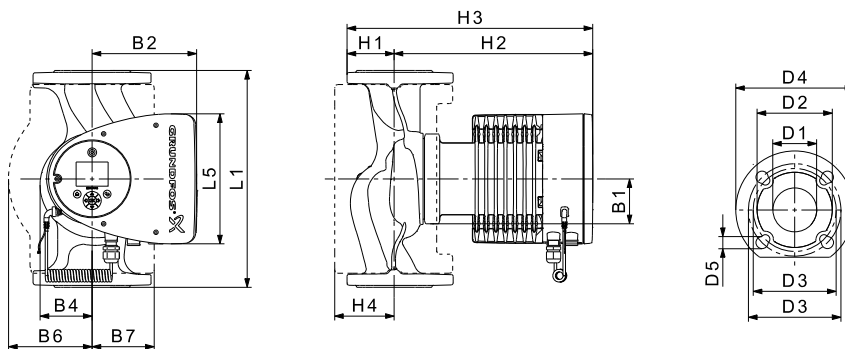

TM05 2204 3612

Pump type	Dimensions [mm]															
	L1	L5	B1	B2	B4	B6	B7	H1	H2	H3	H4	D1	D2	D3	D4	D5
MAGNA3 40-120 F (N)	250	204	84	164	73	106	128	65	304	369	83	40	84	100/110	150	14/19

For product numbers, see page 106.

MAGNA3 D 40-120 F

1 x 230 V, 50/60 Hz

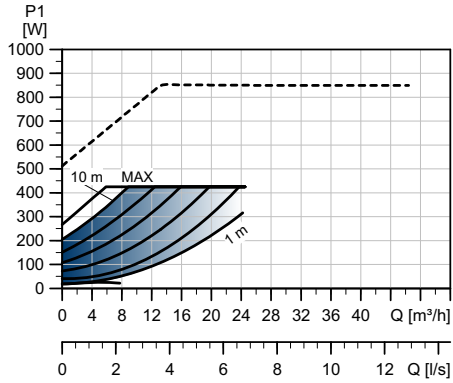
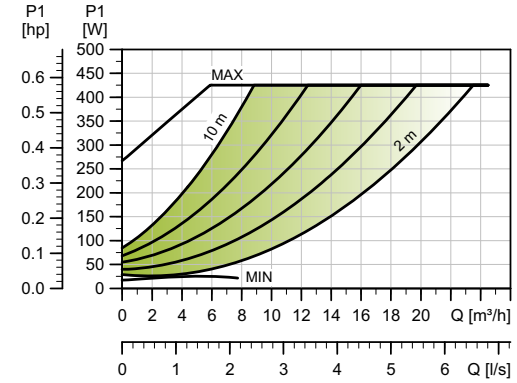
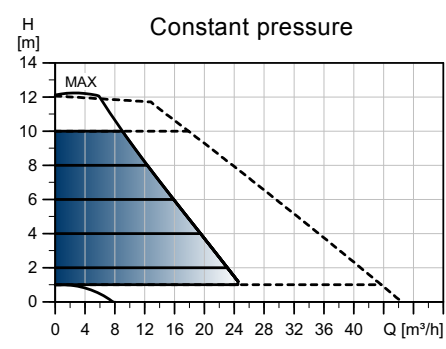
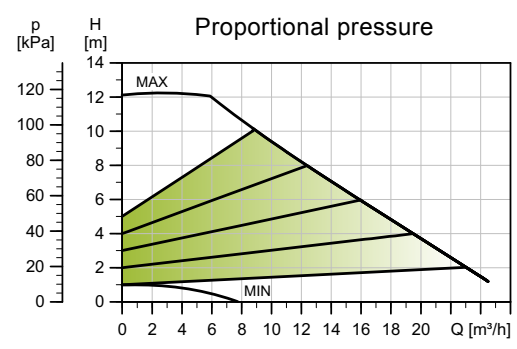

TM05 3790 1912

Speed	P1 [W]	I _{1/1} [A]
Min.	16	0.18
Max.	439	1.95

The pump incorporates overload protection.

Connections: See Counter flanges, page 39.
 System pressure: Max. 1.0 MPa (10 bar). Also available as max. 1.6 MPa (16 bar).
 Liquid temperature: -10 °C to +110 °C (TF 110).
 Specific EEI: 0.18.

Net weights [kg]	Gross weights [kg]	Ship. vol. [m ³]
31.7	31.9	0.04

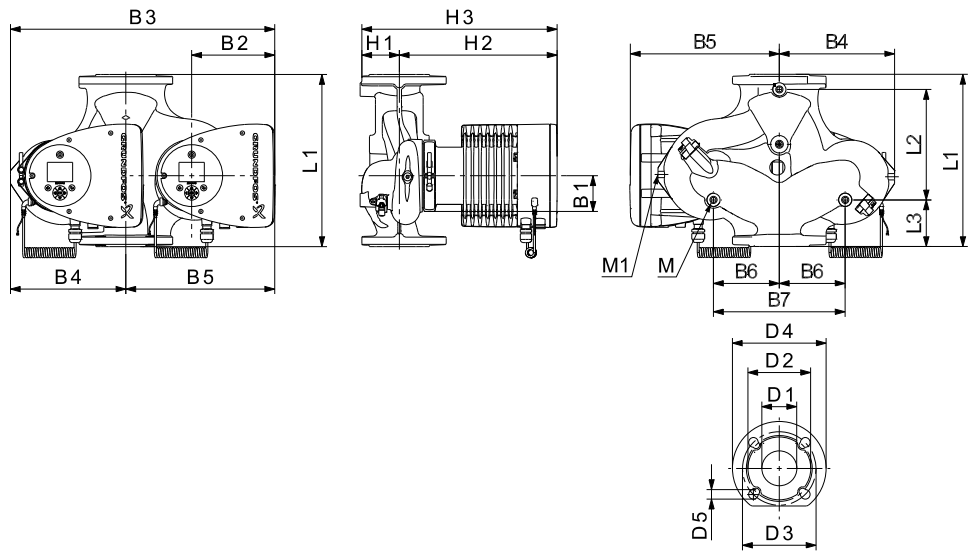

TM05 2205 3612

Pump type	Dimensions [mm]																				
	L1	L2	L3	L4	L5	B1	B3	B4	B5	B6	B7	H1	H2	H3	D1	D2	D3	D4	D5	M	M1
MAGNA3 D 40-120 F	250	58	155	75	204	84	512	220	294	130	260	69	303	372	40	84	100/110	150	14/19	M12	Rp 1/4

For product numbers, see page 106.

MAGNA3 40-150 F (N)

1 x 230 V, 50/60 Hz

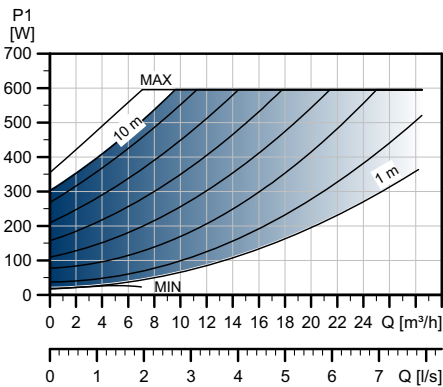
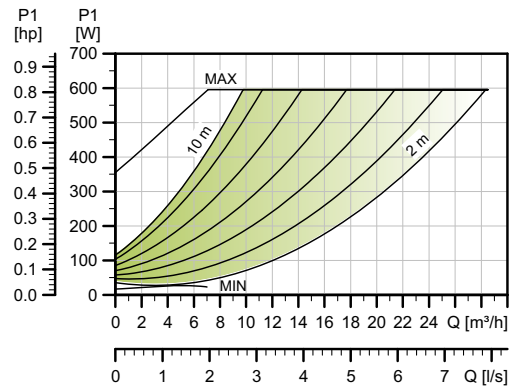
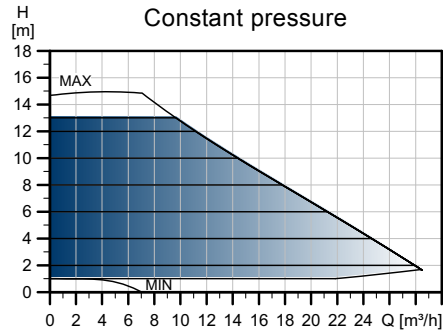
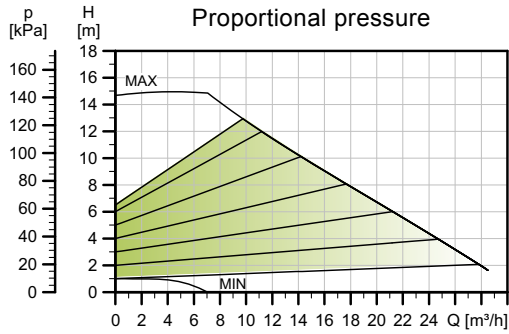

TM05 3737 1912

Speed	P1 [W]	I _{1/1} [A]
Min.	17	0.19
Max.	608	2.69

The pump incorporates overload protection.

Net weights [kg]	Gross weights [kg]	Ship. vol. [m ³]
15.5	18.2	0.04

Connections:

See *Counter flanges*, page 39.

System pressure:

Max. 1.0 MPa (10 bar).
Also available as max. 1.6 MPa (16 bar).

Liquid temperature:

-10 °C to +110 °C (TF 110).

Also available with:

Stainless-steel pump housing, type N.
0.18.

Specific EEI:

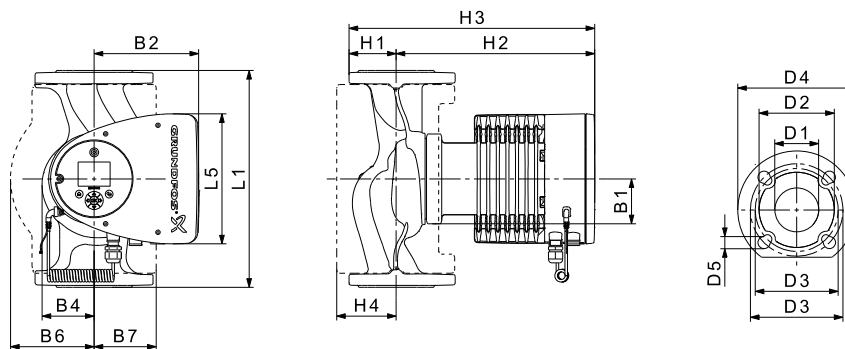

TM05 2204 3612

Pump type	Dimensions [mm]															
	L1	L5	B1	B2	B4	B6	B7	H1	H2	H3	H4	D1	D2	D3	D4	D5
MAGNA3 40-150 F (N)	250	204	84	164	73	106	128	65	304	369	83	40	84	100/110	150	14/19

For product numbers, see page 106.

MAGNA3 D 40-150 F

1 x 230 V, 50/60 Hz

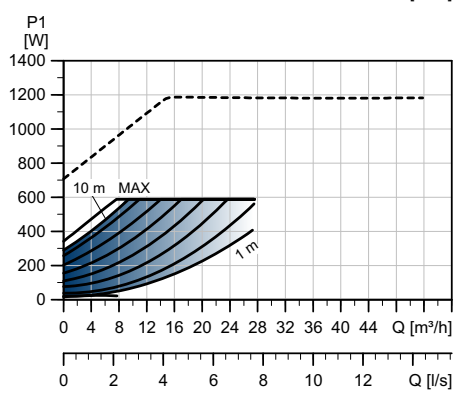
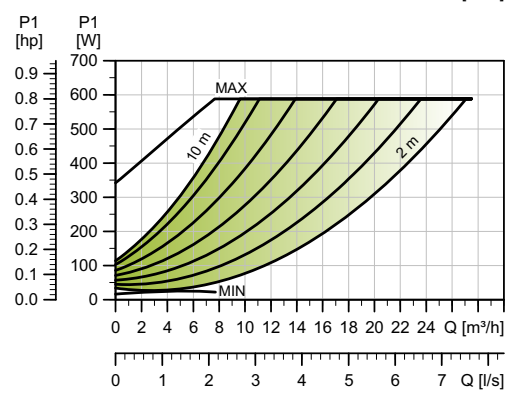
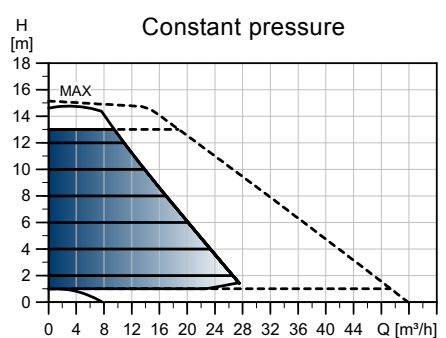
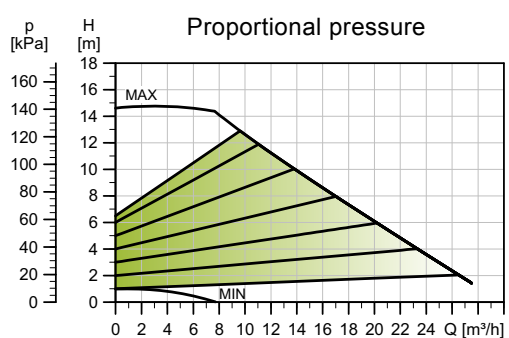

TM05 3791 1912

Speed	P1 [W]	I _{1/1} [A]
Min.	16	0.18
Max.	611	2.70

The pump incorporates overload protection.

Connections: See Counter flanges, page 39.
 System pressure: Max. 1.0 MPa (10 bar). Also available as max. 1.6 MPa (16 bar).
 Liquid temperature: -10 °C to +110 °C (TF 110).
 Specific EEI: 0.18.

Net weights [kg]	Gross weights [kg]	Ship. vol. [m ³]
31.7	31.9	0.04

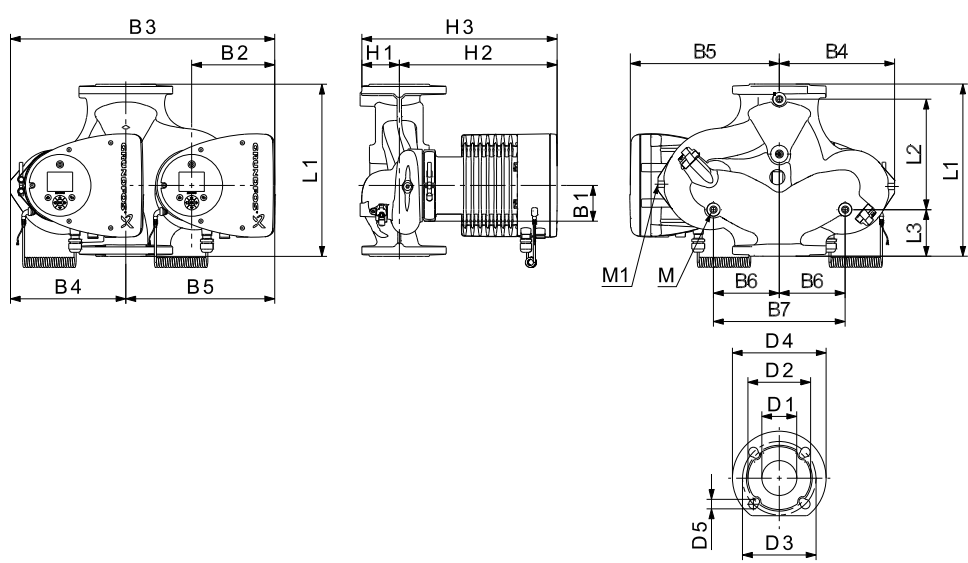

TM05 2205 3612

Pump type	Dimensions [mm]																				
	L1	L2	L3	L4	L5	B1	B3	B4	B5	B6	B7	H1	H2	H3	D1	D2	D3	D4	D5	M	M1
MAGNA3 D 40-150 F	250	58	155	75	204	84	512	220	294	130	260	69	303	372	40	84	100/110	150	14/19	M12	Rp 1/4

For product numbers, see page 106.

MAGNA3 40-180 F (N)

1 x 230 V, 50/60 Hz

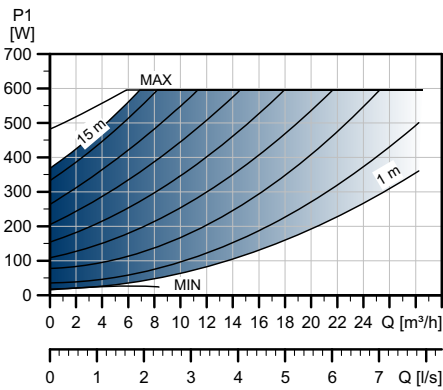
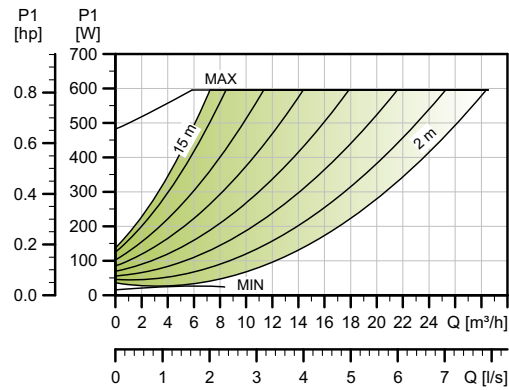
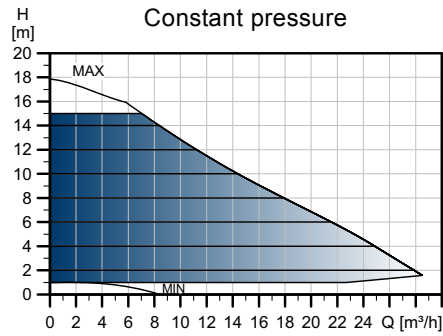
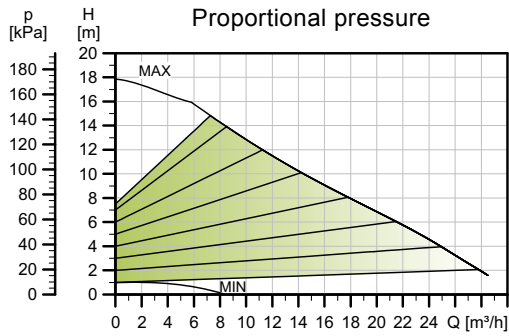

TM05 3738 1912

Speed	P1 [W]	I _{1/1} [A]
Min.	16	0.18
Max.	607	2.68

The pump incorporates overload protection.

Net weights [kg]	Gross weights [kg]	Ship. vol. [m ³]
15.5	18.7	0.04

Connections: See *Counter flanges*, page 39.
 System pressure: Max. 1.0 MPa (10 bar).
 Also available as max. 1.6 MPa (16 bar).
 Liquid temperature: -10 °C to +110 °C (TF 110).
 Also available with: Stainless-steel pump housing, type N.
 Specific EEI: 0.18.

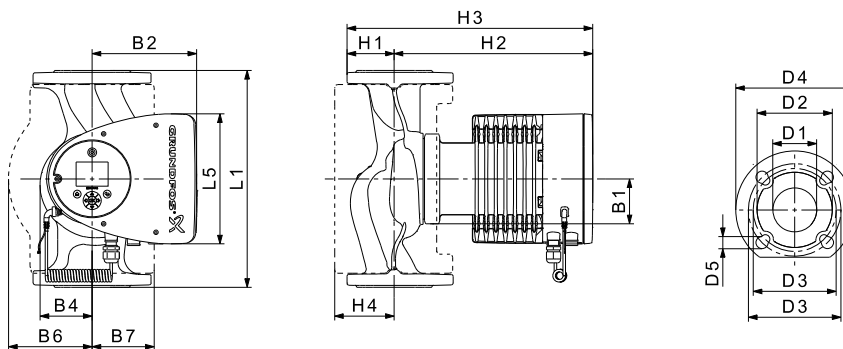

TM05 2204 3612

Pump type	Dimensions [mm]															
	L1	L5	B1	B2	B4	B6	B7	H1	H2	H3	H4	D1	D2	D3	D4	D5
MAGNA3 40-180 F (N)	250	204	84	164	73	106	128	65	304	369	83	40	84	100/110	150	14/19

For product numbers, see page 106.

MAGNA3 D 40-180 F

1 x 230 V, 50/60 Hz

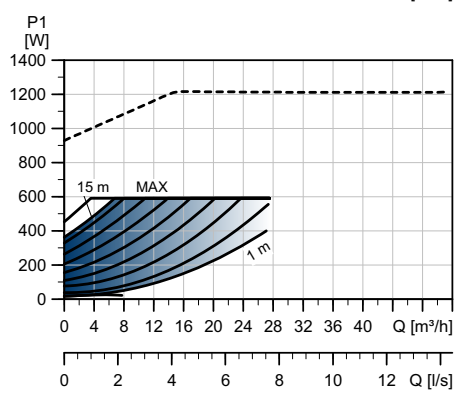
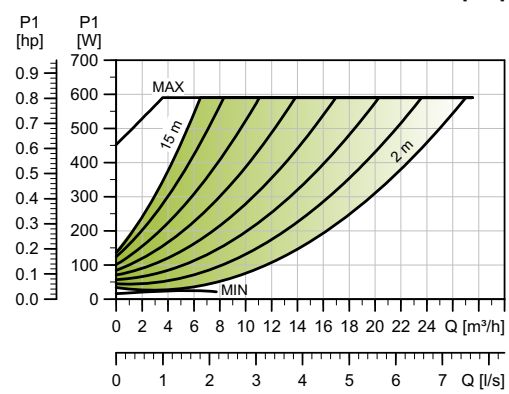
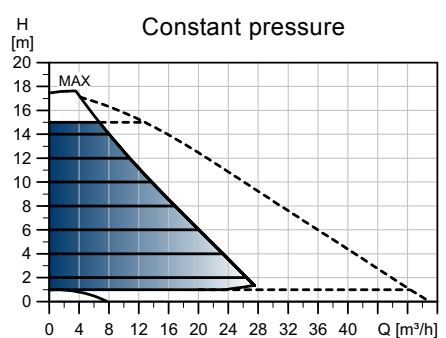
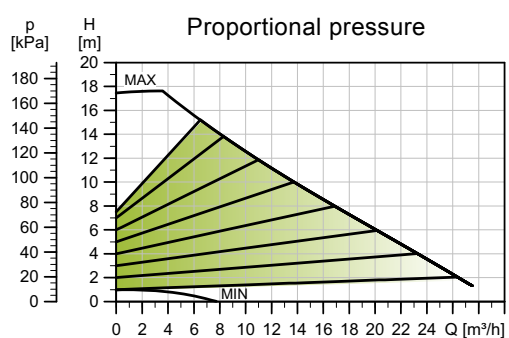

TM05 3763 1912

Speed	P1 [W]	I _{1/1} [A]
Min.	16	0.18
Max.	613	2.71

The pump incorporates overload protection.

Connections: See Counter flanges, page 39.
 System pressure: Max. 1.0 MPa (10 bar). Also available as max. 1.6 MPa (16 bar).
 Liquid temperature: -10 °C to +110 °C (TF 110).
 Specific EEI: 0.18.

Net weights [kg]	Gross weights [kg]	Ship. vol. [m ³]
31.7	31.9	0.04

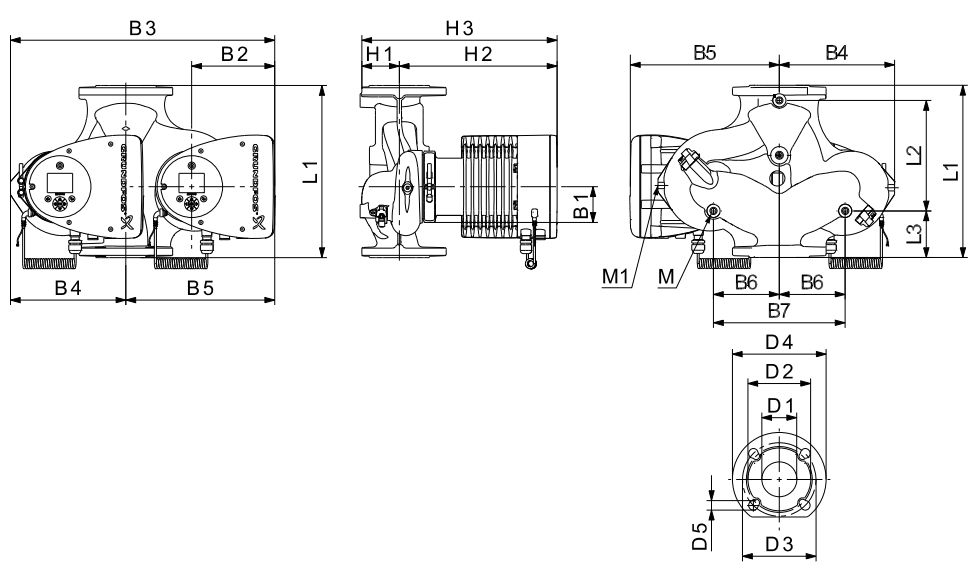

TM05 2205 3612

Pump type	Dimensions [mm]																				
	L1	L2	L3	L4	L5	B1	B3	B4	B5	B6	B7	H1	H2	H3	D1	D2	D3	D4	D5	M	M1
MAGNA3 D 40-180 F	250	58	155	75	204	84	512	220	294	130	260	69	303	372	40	84	100/110	150	14/19	M12	Rp 1/4

For product numbers, see page 106.

MAGNA3 50-40 F (N)

1 x 230 V, 50/60 Hz

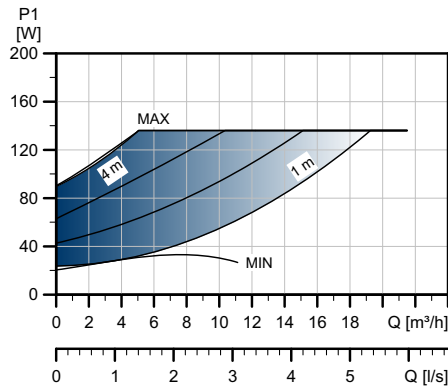
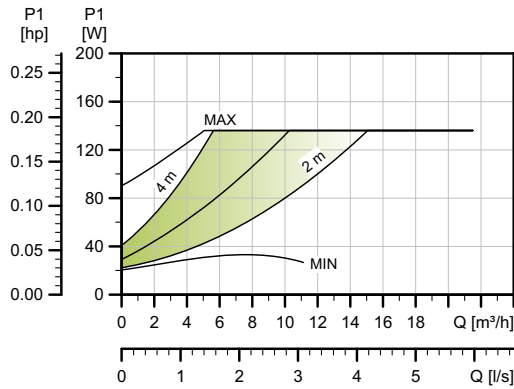
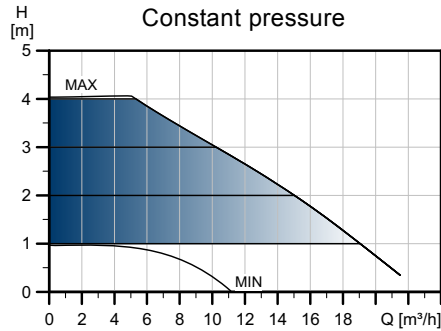
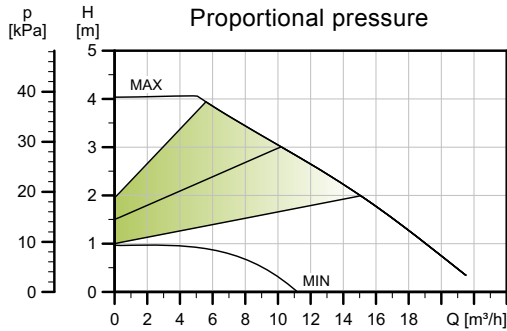

TM05 3739 1912

Speed	P1 [W]	I _{1/1} [A]
Min.	20	0.22
Max.	139	0.67

The pump incorporates overload protection.

Net weights [kg]	Gross weights [kg]	Ship. vol. [m³]
17.0	20.4	0.05

Connections: See *Counter flanges*, page 39.
 System pressure: Max. 1.0 MPa (10 bar).
 Also available as max. 1.6 MPa (16 bar).
 Liquid temperature: -10 °C to +110 °C (TF 110).
 Also available with: Stainless-steel pump housing, type N.
 Specific EEI: 0.20.

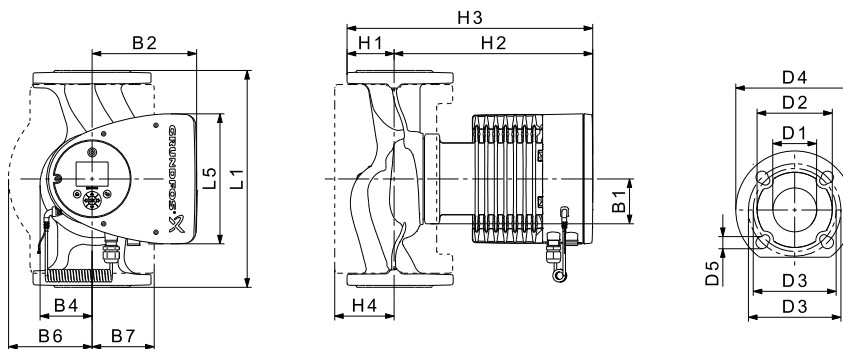

TM05 2204 3612

Pump type	Dimensions [mm]															
	L1	L5	B1	B2	B4	B6	B7	H1	H2	H3	H4	D1	D2	D3	D4	D5
MAGNA3 50-40 F (N)	240	204	84	164	73	127	127	71	304	374	97	50	102	110/125	165	14/19

For product numbers, see page 106.

MAGNA3 D 50-40 F

1 x 230 V, 50/60 Hz

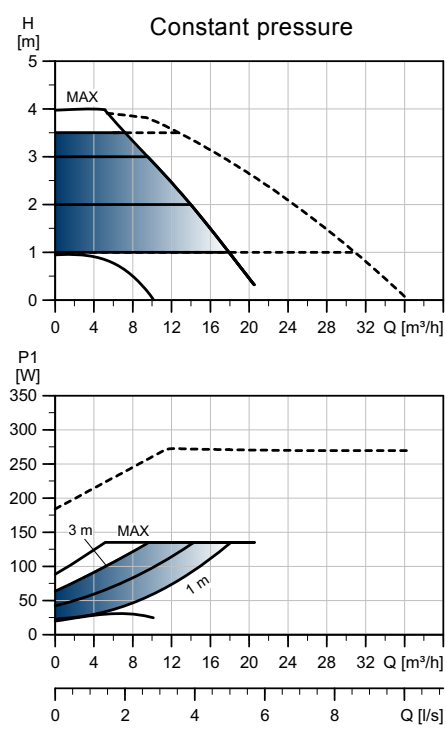
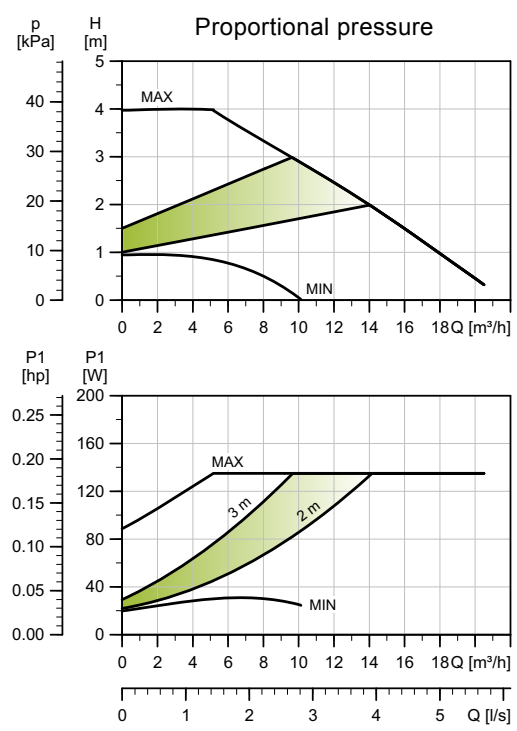

TM05 3764 1912

Speed	P1 [W]	I _{1/1} [A]
Min.	20	0.22
Max.	139	0.66

The pump incorporates overload protection.

Connections: See Counter flanges, page 39.
 System pressure: Max. 1.0 MPa (10 bar). Also available as max. 1.6 MPa (16 bar).
 Liquid temperature: -10 °C to +110 °C (TF 110).
 Specific EEI: 0.20.

Net weights [kg]	Gross weights [kg]	Ship. vol. [m ³]
33.0	41.8	0.05

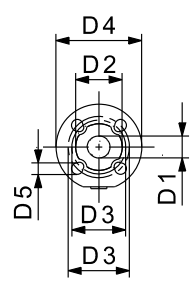
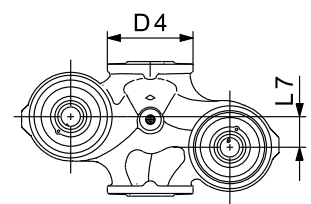
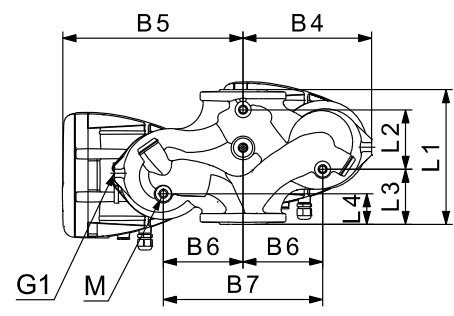
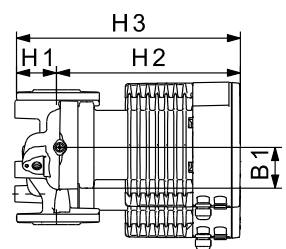
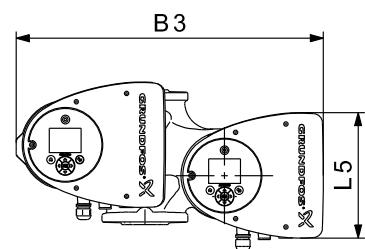

TM05 5294 3612

Pump type	Dimensions [mm]																					
	L1	L2	L3	L4	L5	L7	B1	B3	B4	B5	B6	B7	H1	H2	H3	D1	D2	D3	D4	D5	M	M1
MAGNA3 D 50-40 F	240	48	160	45	204	45	84	515	221	294	130	260	75	304	379	50	102	110/125	165	14/19	M12	Rp 1/4

For product numbers, see page 106.

MAGNA3 50-60 F (N)

1 x 230 V, 50/60 Hz

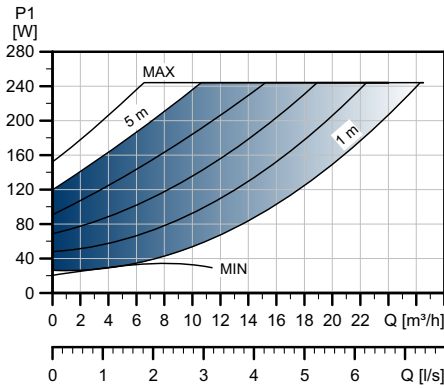
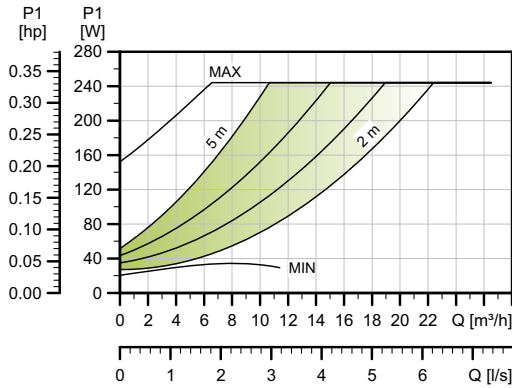
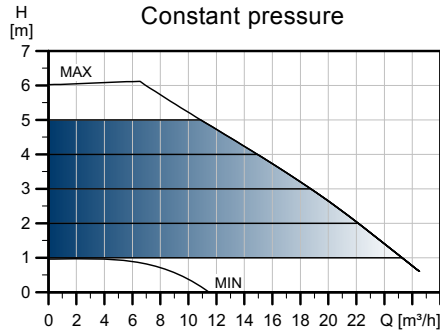
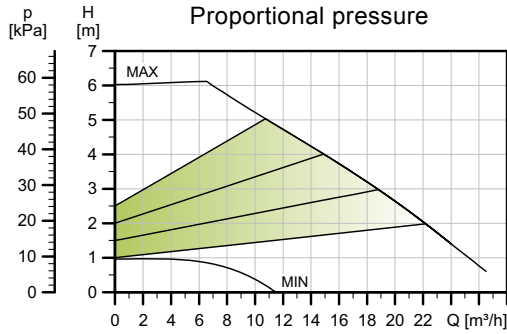

TM05 3740 1912

Speed	P1 [W]	I _{1/1} [A]
Min.	21	0.23
Max.	249	1.13

The pump incorporates overload protection.

Net weights [kg]	Gross weights [kg]	Ship. vol. [m ³]
17.0	20.4	0.05

Connections:

See *Counter flanges*, page 39.

System pressure:

Max. 1.0 MPa (10 bar).
Also available as max. 1.6 MPa (16 bar).

Liquid temperature:

-10 °C to +110 °C (TF 110).

Also available with:

Stainless-steel pump housing, type N.

Specific EEI:

0.19.

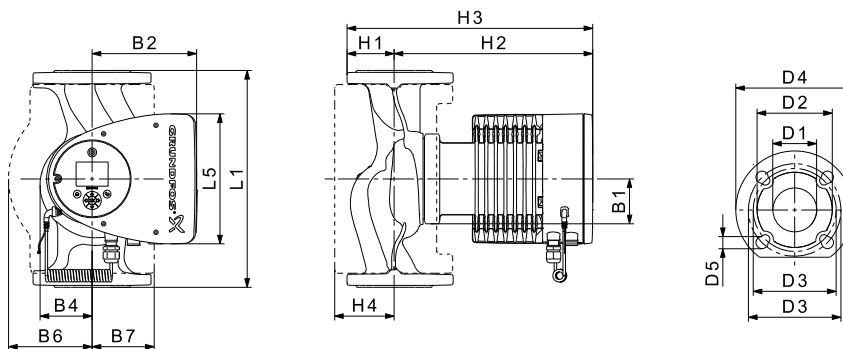

TM05 2204 3612

Pump type	Dimensions [mm]															
	L1	L5	B1	B2	B4	B6	B7	H1	H2	H3	H4	D1	D2	D3	D4	D5
MAGNA3 50-60 F (N)	240	204	84	164	73	127	127	71	304	374	97	50	102	110/125	165	14/19

For product numbers, see page 106.

MAGNA3 D 50-60 F

1 x 230 V, 50/60 Hz

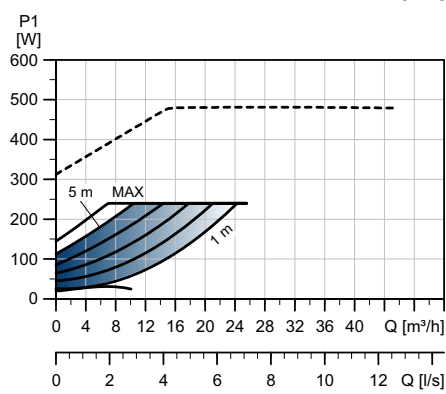
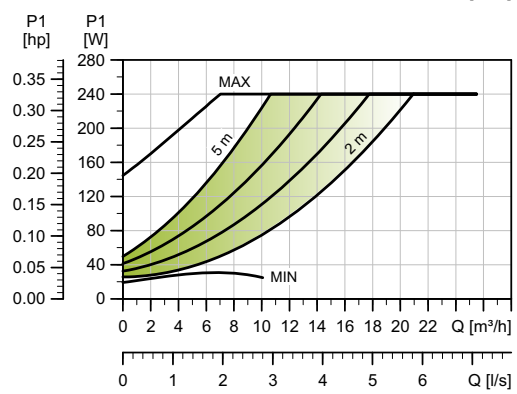
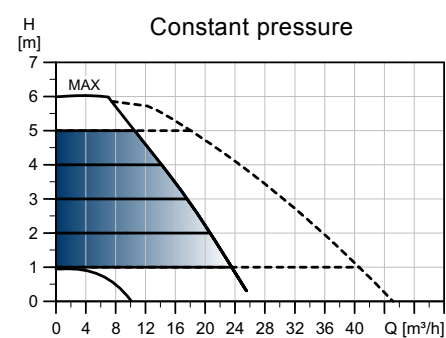
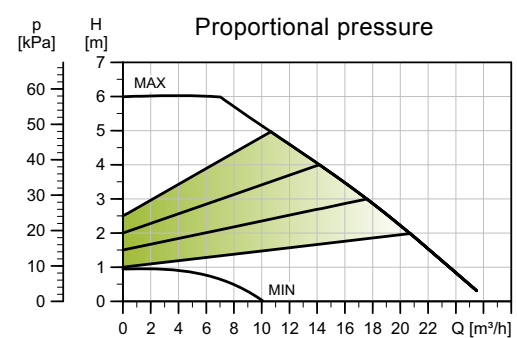

TM05 3765 1912

Speed	P1 [W]	I _{1/1} [A]
Min.	20	0.21
Max.	244	1.11

The pump incorporates overload protection.

Connections: See Counter flanges, page 39.
 System pressure: Max. 1.0 MPa (10 bar). Also available as max. 1.6 MPa (16 bar).
 Liquid temperature: -10 °C to +110 °C (TF 110).
 Specific EEI: 0.19.

Net weights [kg]	Gross weights [kg]	Ship. vol. [m ³]
33.0	41.8	0.05

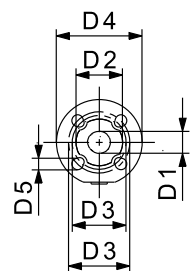
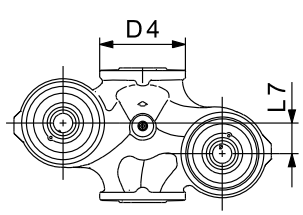
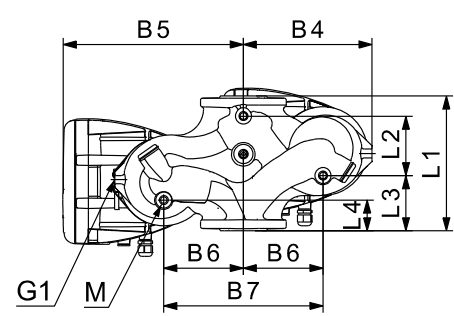
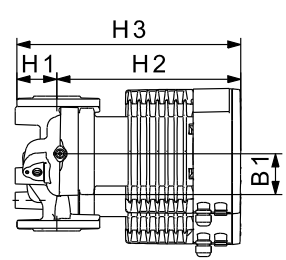
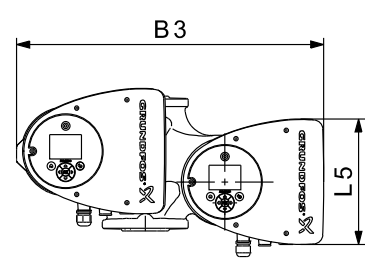

TM05 5294 3612

Pump type	Dimensions [mm]																					
	L1	L2	L3	L4	L5	L7	B1	B3	B4	B5	B6	B7	H1	H2	H3	D1	D2	D3	D4	D5	M	M1
MAGNA3 D 50-60 F	240	48	160	45	204	45	84	515	221	294	130	260	75	304	379	50	102	110/125	165	14/19	M12	Rp 1/4

For product numbers, see page 106.

MAGNA3 50-80 F (N)

1 x 230 V, 50/60 Hz

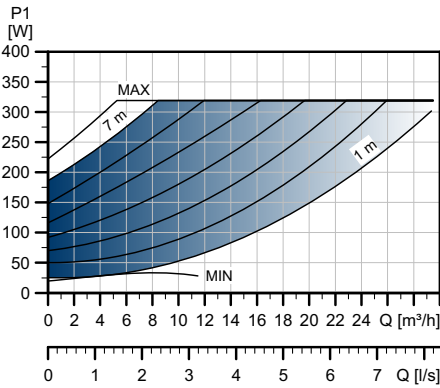
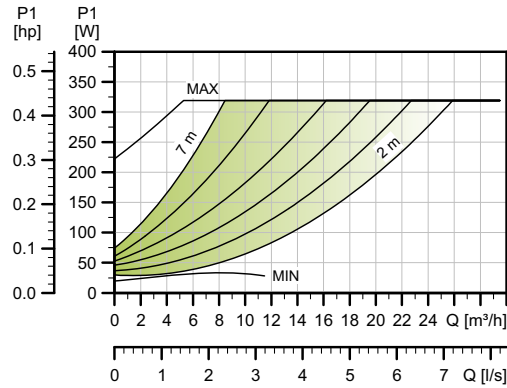
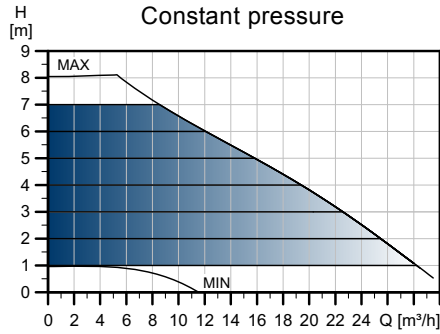
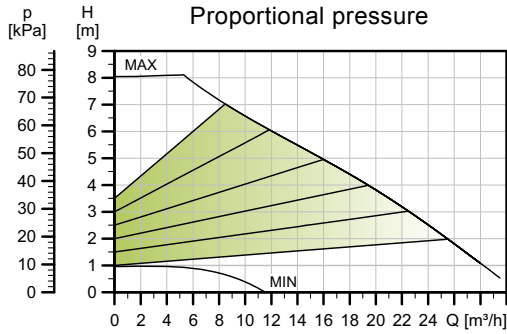

TM05 3741 1912

Speed	P1 [W]	I _{1/1} [A]
Min.	21	0.22
Max.	325	1.46

The pump incorporates overload protection.

Net weights [kg]	Gross weights [kg]	Ship. vol. [m ³]
17.0	20.4	0.05

Connections:

See *Counter flanges*, page 39.

System pressure:

Max. 1.0 MPa (10 bar).
Also available as max. 1.6 MPa (16 bar).

Liquid temperature:

-10 °C to +110 °C (TF 110).

Also available with:

Stainless-steel pump housing, type N.
0.18.

Specific EEI:

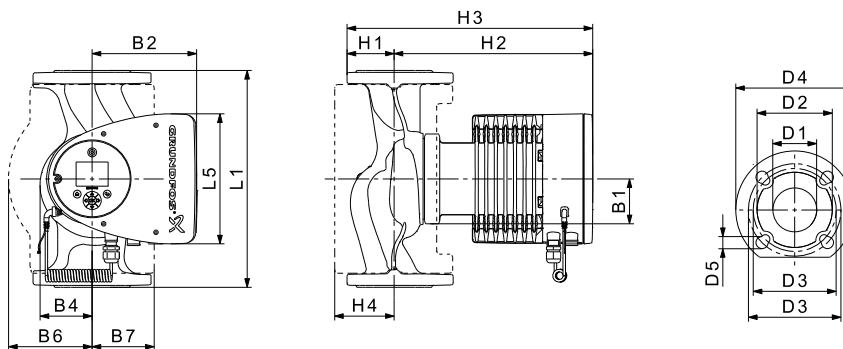

TM05 2204 3612

Pump type	Dimensions [mm]																
	L1	L5	B1	B2	B4	B6	B7	H1	H2	H3	H4	D1	D2	D3	D4	D5	M
MAGNA3 50-80 F (N)	240	204	84	164	73	127	127	71	304	374	97	50	102	110/125	165	14/19	M12

For product numbers, see page 106.

MAGNA3 D 50-80 F

1 x 230 V, 50/60 Hz

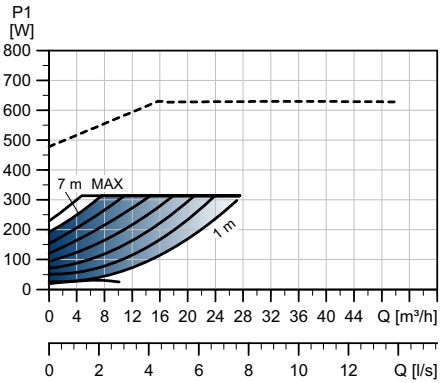
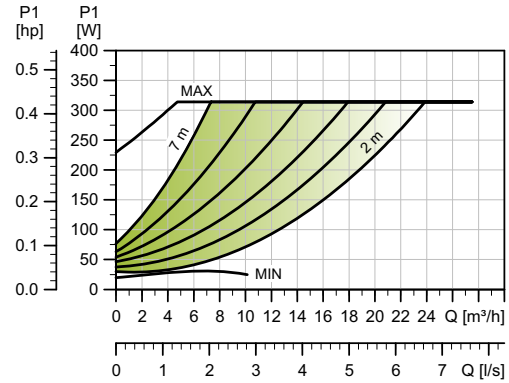
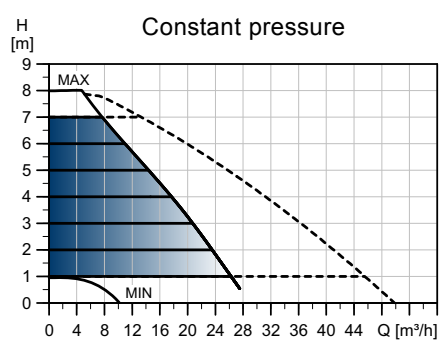
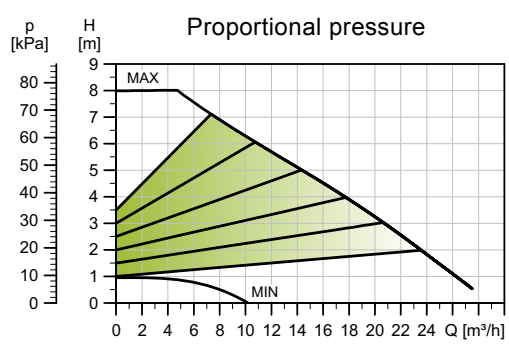

TM05 5294 3612

Speed	P1 [W]	I _{1/1} [A]
Min.	21	0.22
Max.	324	1.45

The pump incorporates overload protection.

Connections: See Counter flanges, page 39.
 System pressure: Max. 1.0 MPa (10 bar). Also available as max. 1.6 MPa (16 bar).
 Liquid temperature: -10 °C to +110 °C (TF 110).
 Specific EEI: 0.19.

Net weights [kg]	Gross weights [kg]	Ship. vol. [m ³]
33.0	41.8	0.05

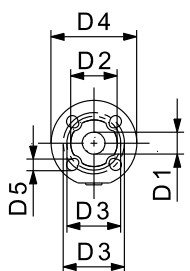
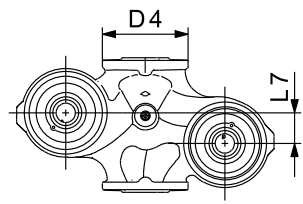
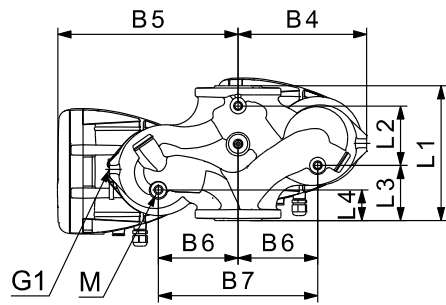
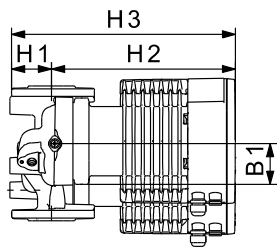
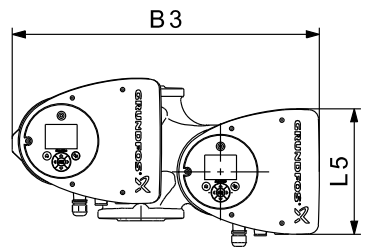

TM05 5294 3612

Pump type	Dimensions [mm]																					
	L1	L2	L3	L4	L5	L7	B1	B3	B4	B5	B6	B7	H1	H2	H3	D1	D2	D3	D4	D5	M	M1
MAGNA3 D 50-80 F	240	48	160	45	204	45	84	515	221	294	130	260	75	304	379	50	102	110/125	165	14/19	M12	Rp 1/4

For product numbers, see page 106.

MAGNA3 50-100 F (N)

1 x 230 V, 50/60 Hz

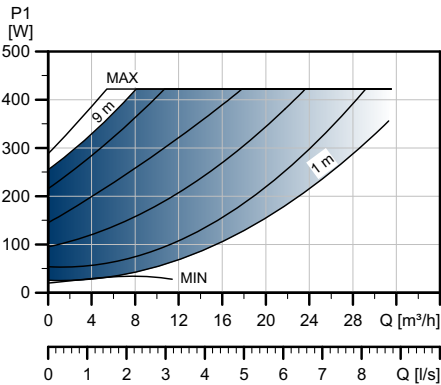
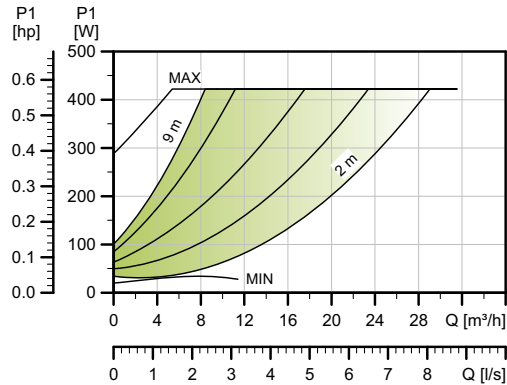
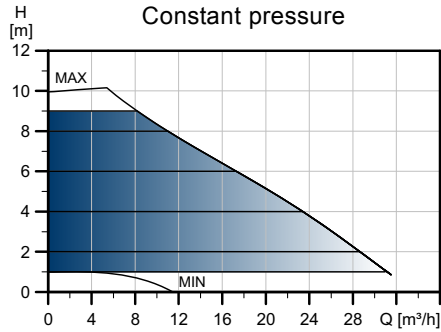
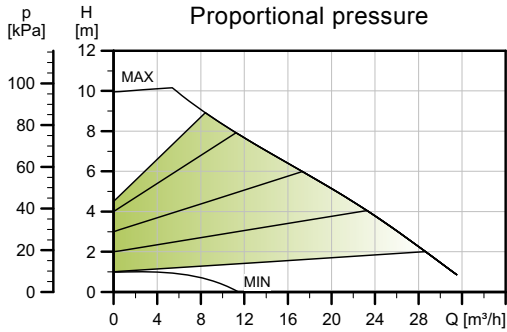

TM05 3742 1912

Speed	P1 [W]	I _{1/1} [A]
Min.	21	0.22
Max.	429	1.91

The pump incorporates overload protection.

Net weights [kg]	Gross weights [kg]	Ship. vol. [m ³]
17.6	21.1	0.05

Connections:

See *Counter flanges*, page 39.

System pressure:

Max. 1.0 MPa (10 bar).
Also available as max. 1.6 MPa (16 bar).

Liquid temperature:

-10 °C to +110 °C (TF 110).

Also available with:

Stainless-steel pump housing, type N.
0.18.

Specific EEI:

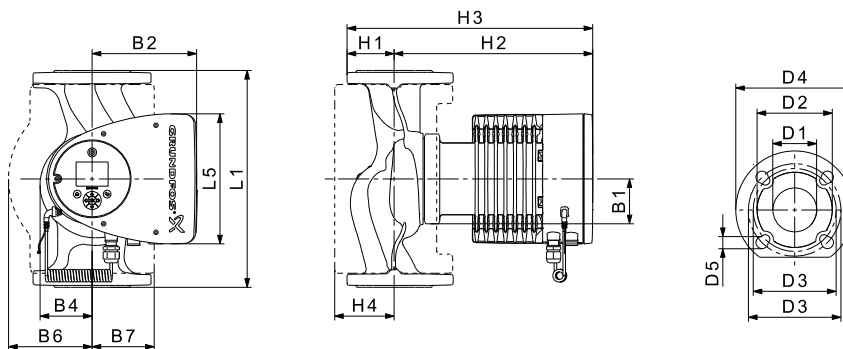

TM05 2204 3612

Pump type	Dimensions [mm]																
	L1	L5	B1	B2	B4	B6	B7	H1	H2	H3	H4	D1	D2	D3	D4	D5	M
MAGNA3 50-100 F (N)	280	204	84	164	73	127	127	72	304	376	97	50	102	110/125	165	14/19	M12

For product numbers, see page 106.

MAGNA3 D 50-100 F

1 x 230 V, 50/60 Hz

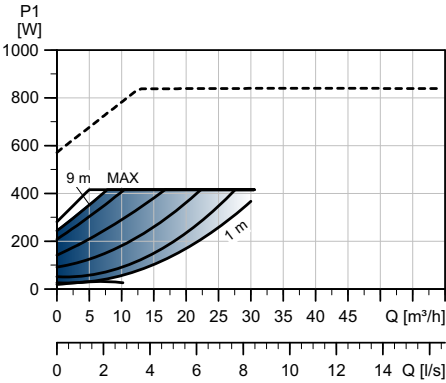
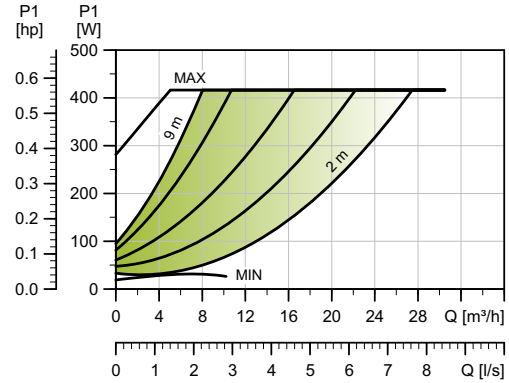
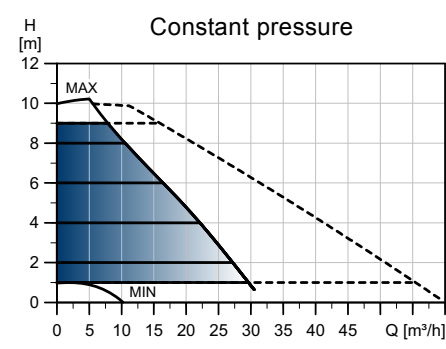
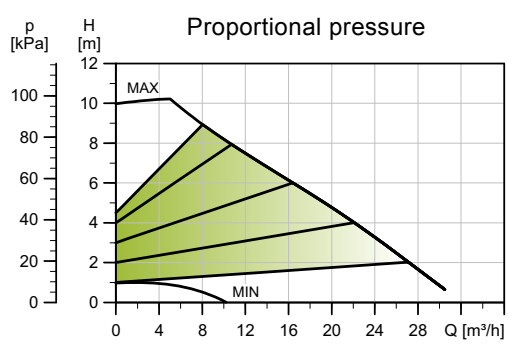

TM05 3767 1912

Speed	P1 [W]	I _{1/1} [A]
Min.	20	0.21
Max.	430	1.91

The pump incorporates overload protection.

Connections: See Counter flanges, page 39.
 System pressure: Max. 1.0 MPa (10 bar). Also available as max. 1.6 MPa (16 bar).
 Liquid temperature: -10 °C to +110 °C (TF 110).
 Specific EEI: 0.18.

Net weights [kg]	Gross weights [kg]	Ship. vol. [m ³]
33.3	42.1	0.05

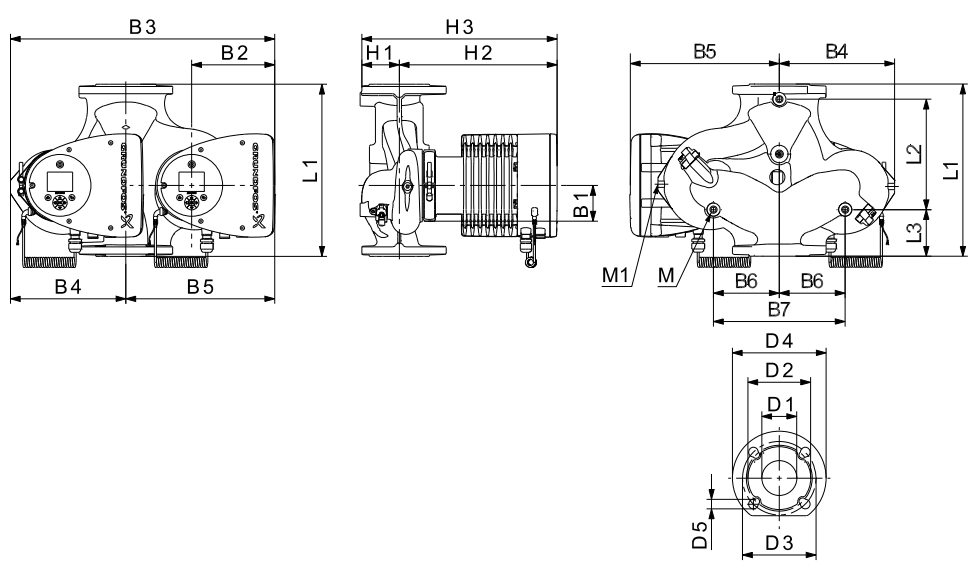

TM05 2205 3612

Pump type	Dimensions [mm]																				
	L1	L2	L3	L4	L5	B1	B3	B4	B5	B6	B7	H1	H2	H3	D1	D2	D3	D4	D5	M	M1
MAGNA3 D 50-100 F	280	175	75	75	204	84	517	223	294	130	260	75	304	379	50	102	110/125	165	14/19	M12	Rp 1/4

For product numbers, see page 106.

MAGNA3 50-120 F (N)

1 x 230 V, 50/60 Hz

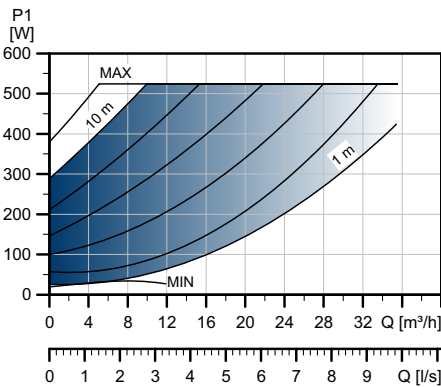
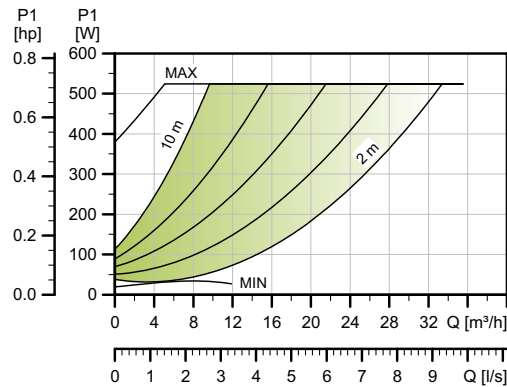
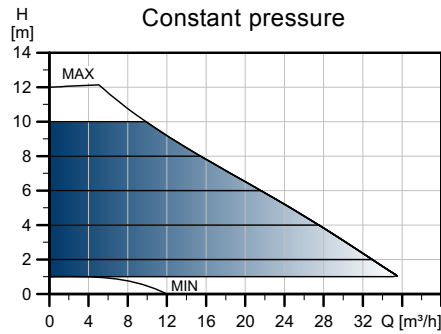
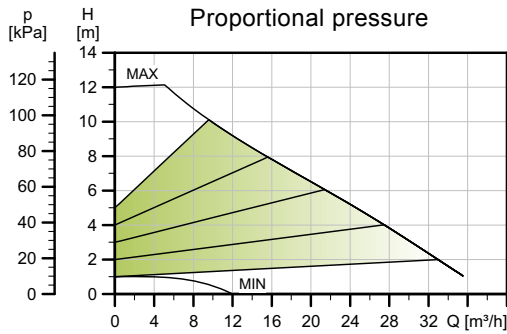

TM05 3743 1912

Speed	P1 [W]	I _{1/I1} [A]
Min.	20	0.22
Max.	536	2.37

The pump incorporates overload protection.

Net weights [kg]	Gross weights [kg]	Ship. vol. [m ³]
17.6	21.1	0.05

Connections:

See *Counter flanges*, page 39.

System pressure:

Max. 1.0 MPa (10 bar).
Also available as max. 1.6 MPa (16 bar).

Liquid temperature:

-10 °C to +110 °C (TF 110).

Also available with:

Stainless-steel pump housing, type N.
Specific EEI: 0.18.

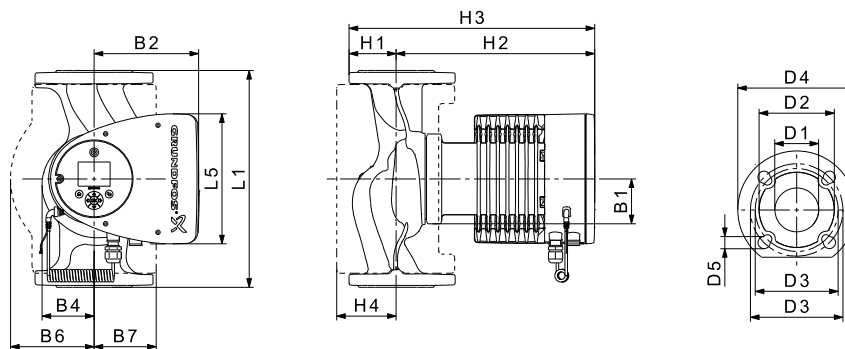

TM05 2204 3612

Pump type	Dimensions [mm]															
	L1	L5	B1	B2	B4	B6	B7	H1	H2	H3	H4	D1	D2	D3	D4	D5
MAGNA3 50-120 F (N)	280	204	84	164	73	127	127	72	304	376	97	50	102	110/125	165	14/19

For product numbers, see page 106.

MAGNA3 D 50-120 F

1 x 230 V, 50/60 Hz

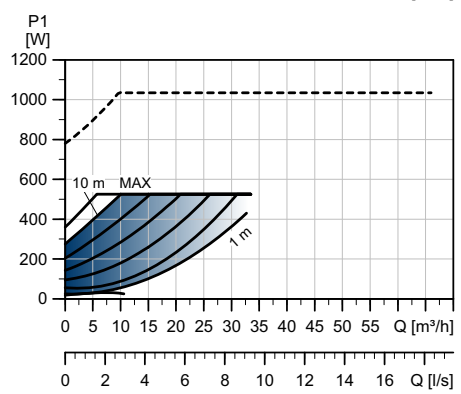
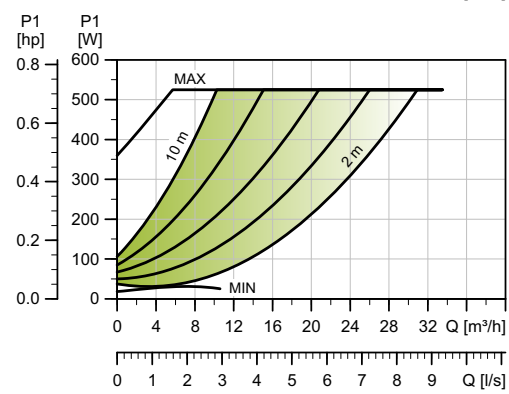
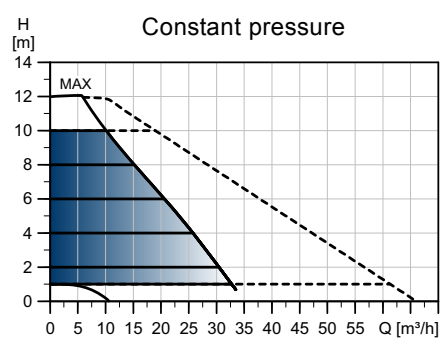
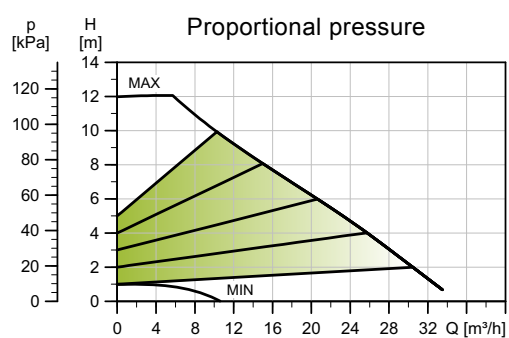

TM05 3768 1912

Speed	P1 [W]	I _{1/1} [A]
Min.	19	0.20
Max.	536	2.37

The pump incorporates overload protection.

Connections: See Counter flanges, page 39.
 System pressure: Max. 1.0 MPa (10 bar). Also available as max. 1.6 MPa (16 bar).
 Liquid temperature: -10 °C to +110 °C (TF 110).
 Specific EEI: 0.18.

Net weights [kg]	Gross weights [kg]	Ship. vol. [m ³]
33.3	42.1	0.05

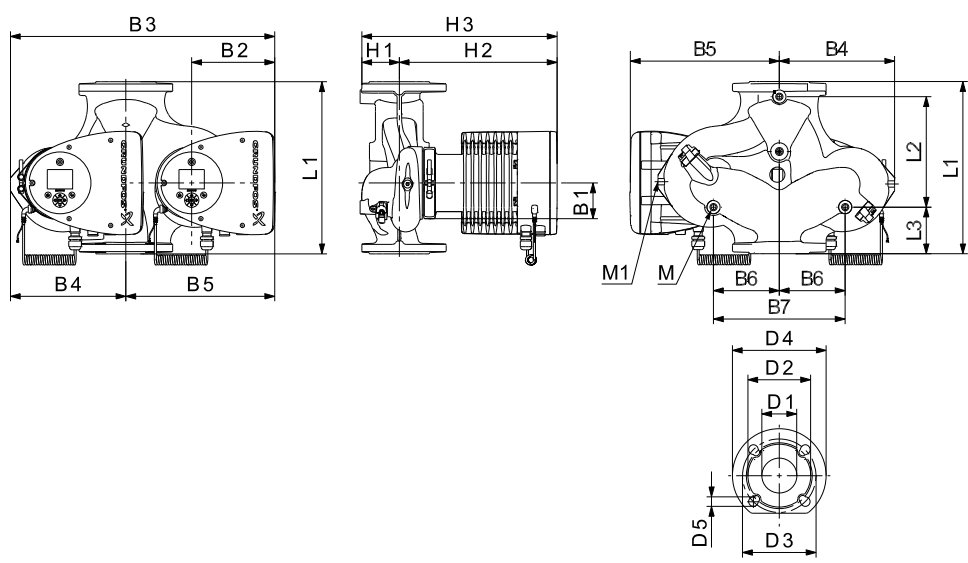

TM05 2205 3612

Pump type	Dimensions [mm]																				
	L1	L2	L3	L4	L5	B1	B3	B4	B5	B6	B7	H1	H2	H3	D1	D2	D3	D4	D5	M	M1
MAGNA3 D 50-120 F	280	175	75	75	204	84	517	223	294	130	260	75	304	379	50	102	110/125	165	14/19	M12	Rp 1/4

For product numbers, see page 106.

MAGNA3 50-150 F (N)

1 x 230 V, 50/60 Hz

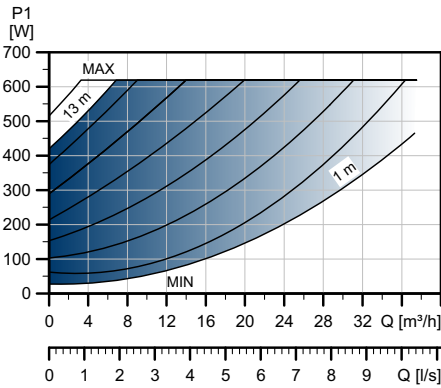
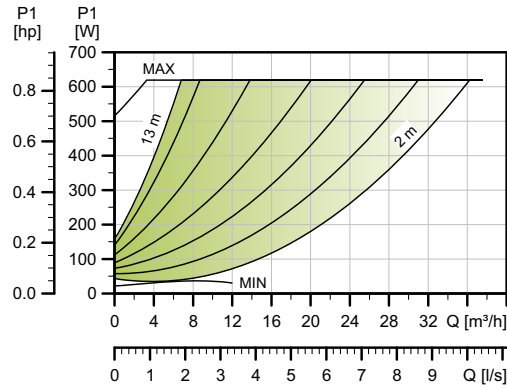
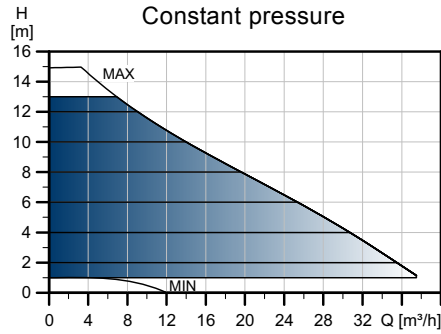
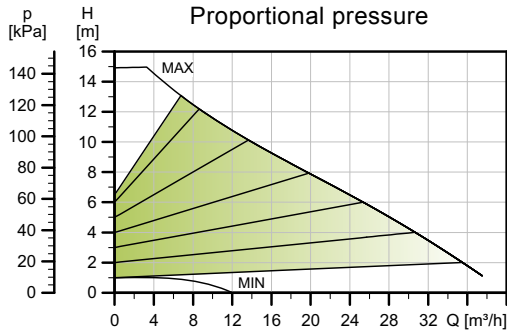

TM05 3744 1912

Speed	P1 [W]	I _{1/1} [A]
Min.	22	0.23
Max.	630	2.78

The pump incorporates overload protection.

Net weights [kg]	Gross weights [kg]	Ship. vol. [m ³]
18.3	22.0	0.05

Connections: See *Counter flanges*, page 39.
 System pressure: Max. 1.0 MPa (10 bar). Also available as max. 1.6 MPa (16 bar).
 Liquid temperature: -10 °C to +110 °C (TF 110).
 Also available with: Stainless-steel pump housing, type N.
 Specific EEI: 0.17.

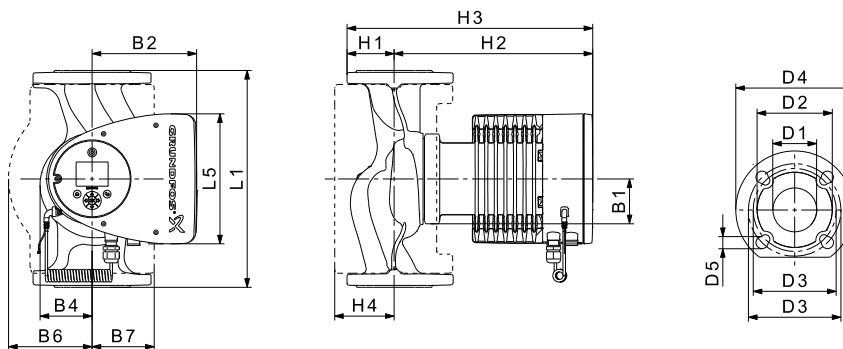

TM05 2204 3612

Pump type	Dimensions [mm]																
	L1	L5	B1	B2	B4	B6	B7	H1	H2	H3	H4	D1	D2	D3	D4	D5	M
MAGNA3 50-150 F (N)	280	204	84	164	73	127	127	72	304	376	97	50	102	110/125	165	14/19	M12

For product numbers, see page 106.

MAGNA3 D 50-150 F

1 x 230 V, 50/60 Hz

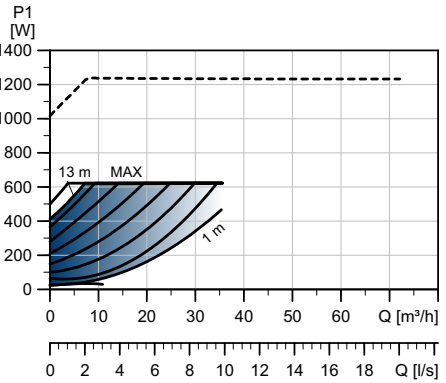
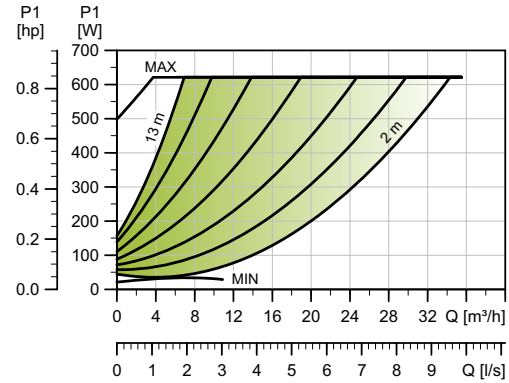
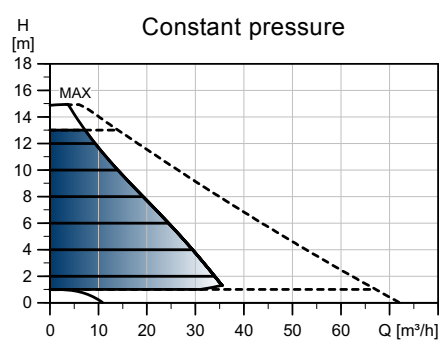
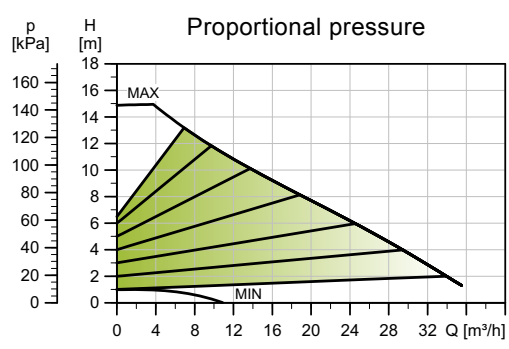

TM05 3769 1912

Speed	P1 [W]	I _{1/1} [A]
Min.	22	0.23
Max.	630	2.78

The pump incorporates overload protection.

Connections: See Counter flanges, page 39.
 System pressure: Max. 1.0 MPa (10 bar). Also available as max. 1.6 MPa (16 bar).
 Liquid temperature: -10 °C to +110 °C (TF 110).
 Specific EEI: 0.18.

Net weights [kg]	Gross weights [kg]	Ship. vol. [m ³]
34.7	43.9	0.05

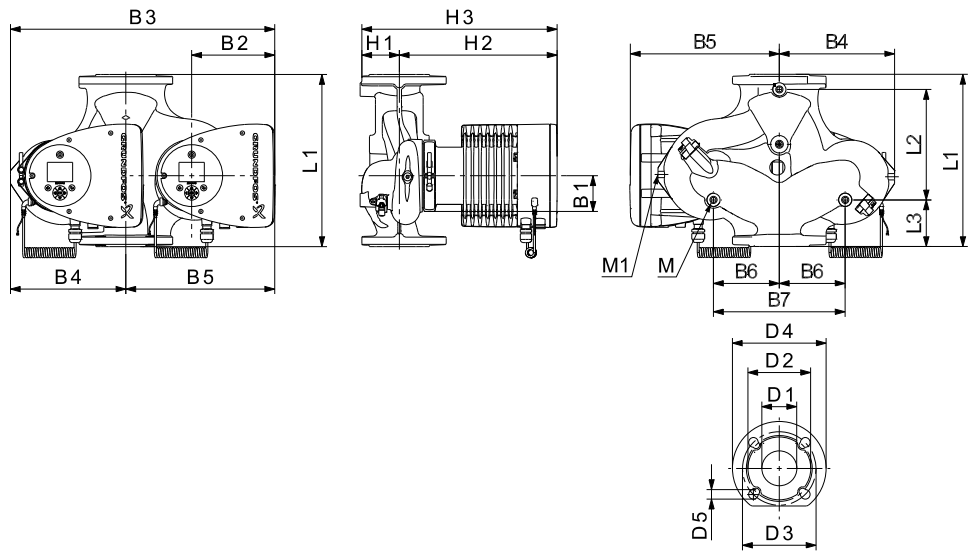

TM05 2205 3612

Pump type	Dimensions [mm]																				
	L1	L2	L3	L4	L5	B1	B3	B4	B5	B6	B7	H1	H2	H3	D1	D2	D3	D4	D5	M	M1
MAGNA3 D 50-150 F	280	175	75	75	204	84	517	223	294	130	260	75	304	379	50	102	110/125	165	14/19	M12	Rp 1/4

For product numbers, see page 106.

MAGNA3 50-180 F (N)

1 x 230 V, 50/60 Hz

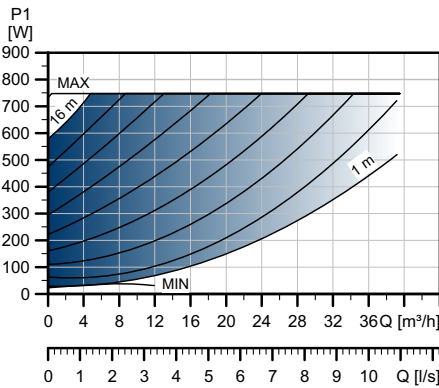
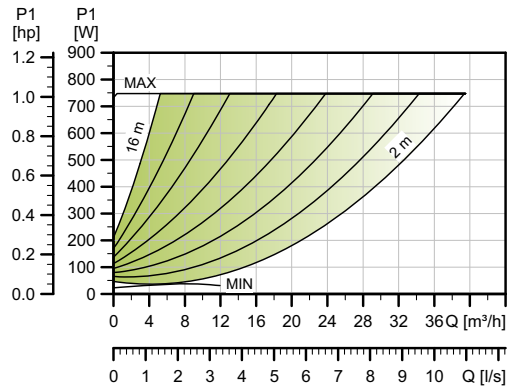
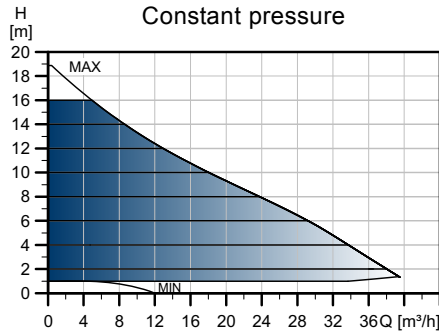
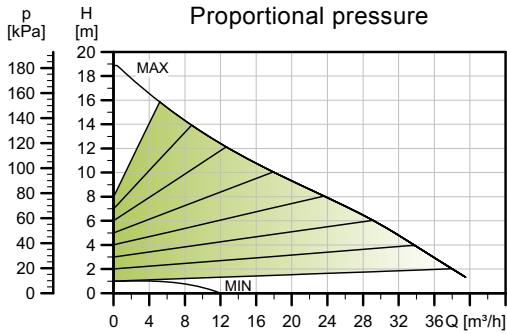

TM05 3745 1912

Speed	P1 [W]	I _{1/I1} [A]
Min.	23	0.24
Max.	762	3.35

The pump incorporates overload protection.

Net weights [kg]	Gross weights [kg]	Ship. vol. [m ³]
18.3	21.9	0.05

Connections:

See *Counter flanges*, page 39.

System pressure:

Max. 1.0 MPa (10 bar).
Also available as max. 1.6 MPa (16 bar).

Liquid temperature:

-10 °C to +110 °C (TF 110).

Also available with:

Stainless-steel pump housing, type N.

Specific EEI:

0.17.

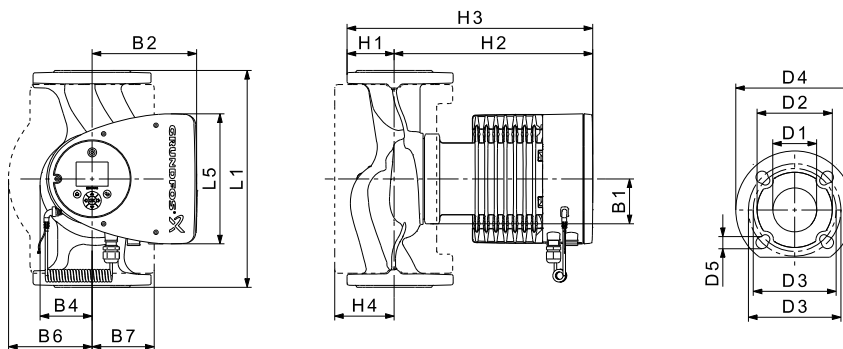

TM05 2204 3612

Pump type	Dimensions [mm]															
	L1	L5	B1	B2	B4	B6	B7	H1	H2	H3	H4	D1	D2	D3	D4	D5
MAGNA3 50-180 F (N)	280	204	84	164	73	127	127	72	304	376	97	50	102	110/125	165	14/19

For product numbers, see page 106.

MAGNA3 D 50-180 F

1 x 230 V, 50/60 Hz

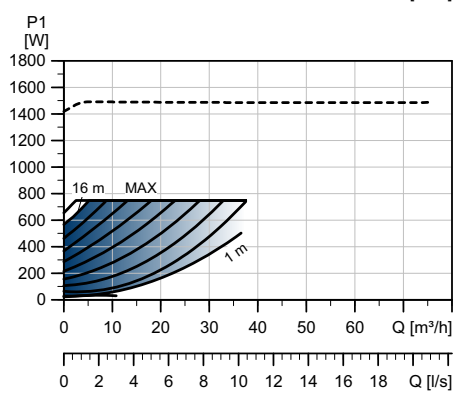
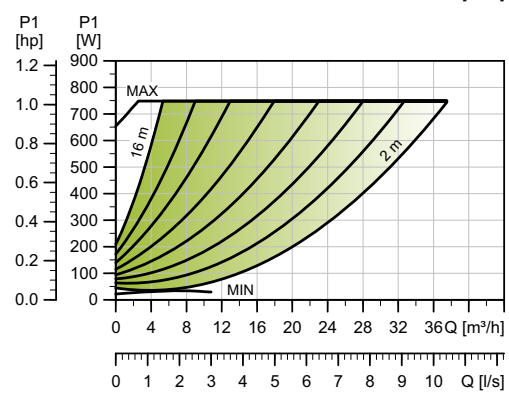
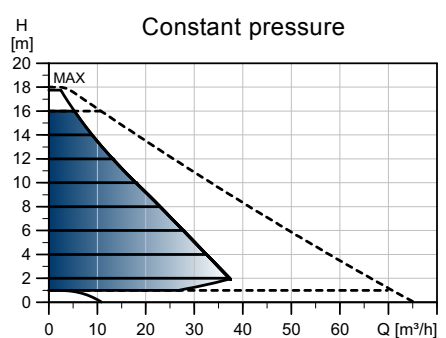
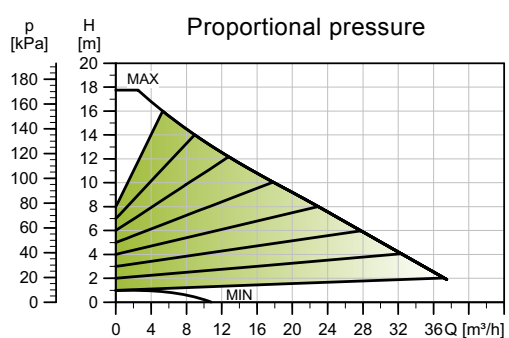

TM05 3770 1912

Speed	P1 [W]	I _{1/I1} [A]
Min.	23	0.24
Max.	762	3.35

The pump incorporates overload protection.

Connections: See Counter flanges, page 39.
 System pressure: Max. 1.0 MPa (10 bar). Also available as max. 1.6 MPa (16 bar).
 Liquid temperature: -10 °C to +110 °C (TF 110).
 Specific EEI: 0.19.

Net weights [kg]	Gross weights [kg]	Ship. vol. [m ³]
34.7	43.9	0.05

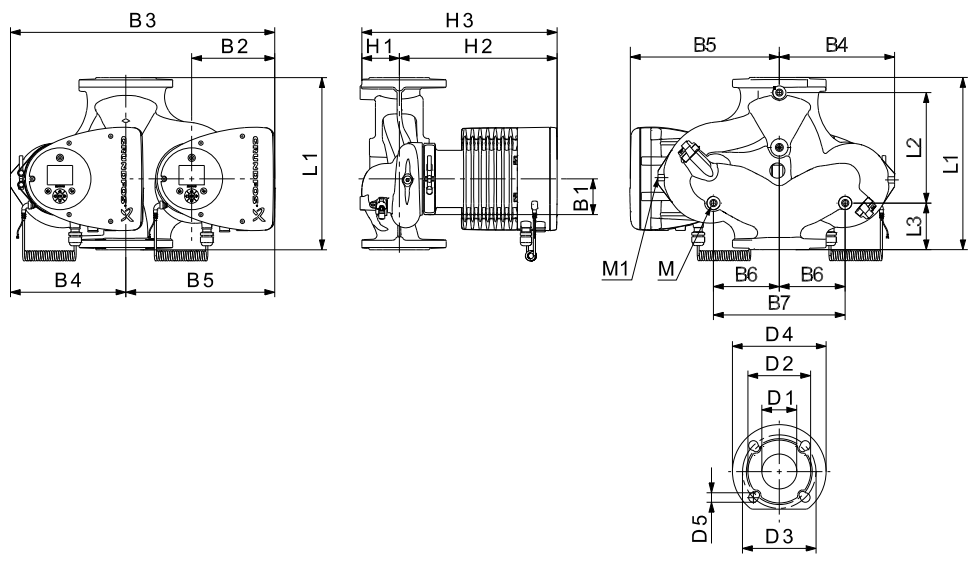

TM05 2205 3612

Pump type	Dimensions [mm]																				
	L1	L2	L3	L4	L5	B1	B3	B4	B5	B6	B7	H1	H2	H3	D1	D2	D3	D4	D5	M	M1
MAGNA3 D 50-180 F	280	175	75	75	204	84	517	223	294	130	260	75	304	379	50	102	110/125	165	14/19	M12	Rp 1/4

For product numbers, see page 106.

MAGNA3 65-40 F (N)

1 x 230 V, 50/60 Hz

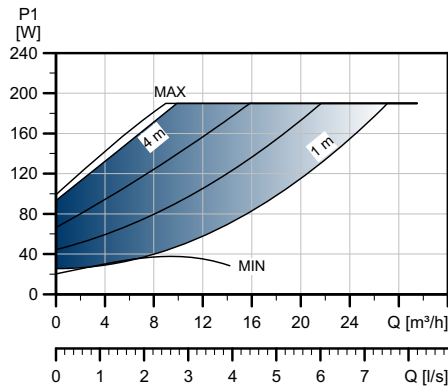
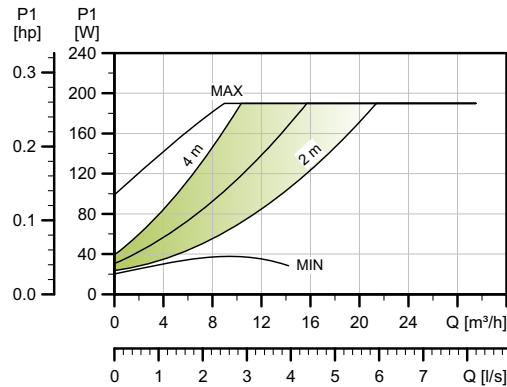
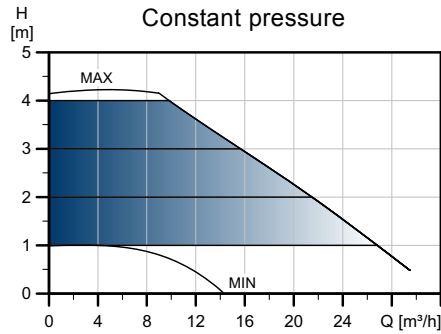
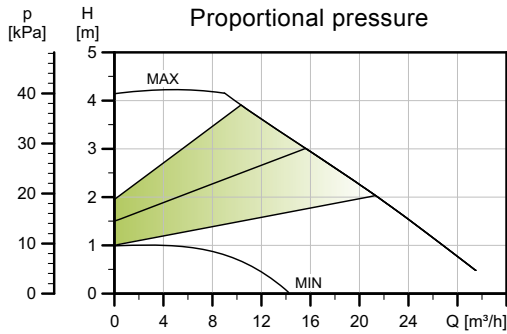

TM05 3746 1912

Speed	P1 [W]	I _{1/1} [A]
Min.	21	0.22
Max.	194	0.90

The pump incorporates overload protection.

Net weights [kg]	Gross weights [kg]	Ship. vol. [m ³]
20.2	23.8	0.06

Connections:

See *Counter flanges*, page 39.

System pressure:

Max. 1.0 MPa (10 bar).
Also available as max. 1.6 MPa (16 bar).

Liquid temperature:

-10 °C to +110 °C (TF 110).

Also available with:

Stainless-steel pump housing, type N.
0.18.

Specific EEI:

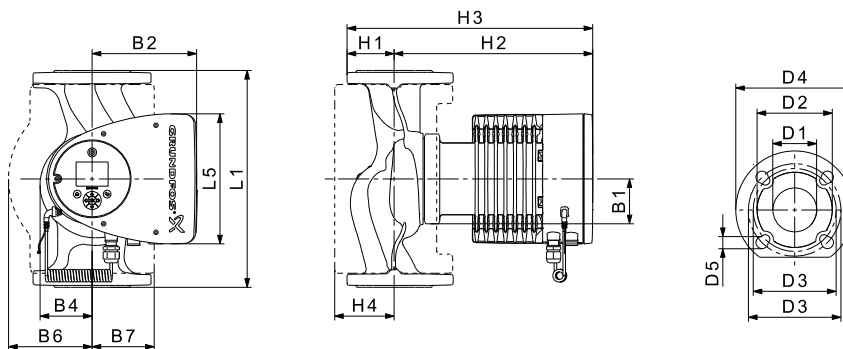

TM05 2204 3612

Pump type	Dimensions [mm]															
	L1	L5	B1	B2	B4	B6	B7	H1	H2	H3	H4	D1	D2	D3	D4	D5
MAGNA3 65-40 F (N)	340	204	84	164	73	133	133	74	312	386	94	65	119	130/145	185	14/19

For product numbers, see page 106.

MAGNA3 D 65-40 F

1 x 230 V, 50/60 Hz

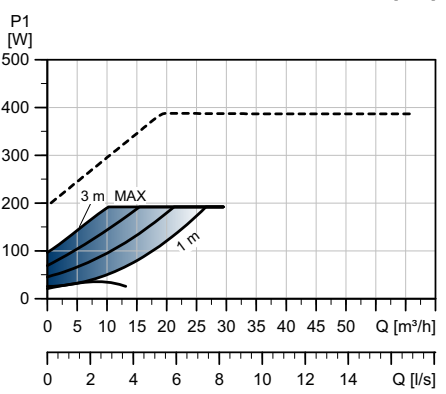
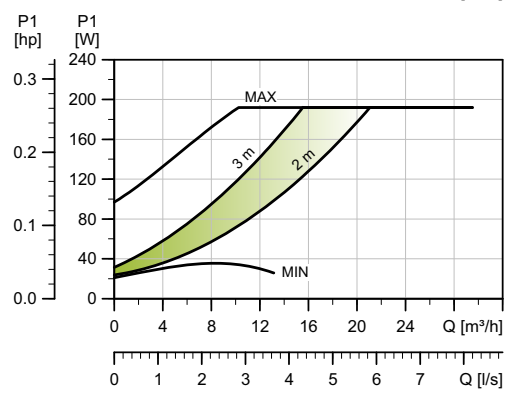
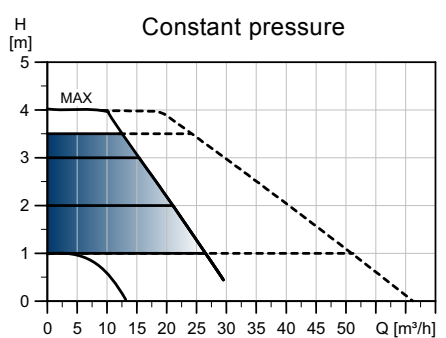
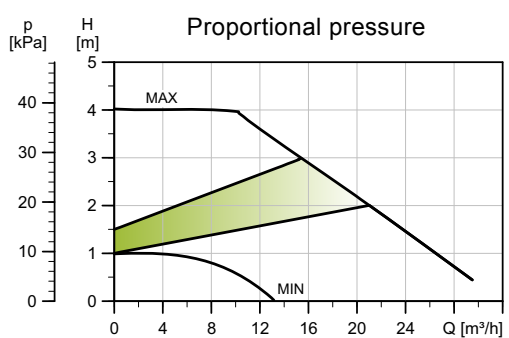

TM05 3771 1912

Speed	P1 [W]	I _{1/1} [A]
Min.	20	0.22
Max.	189	0.89

The pump incorporates overload protection.

Connections: See Counter flanges, page 39.
 System pressure: Max. 1.0 MPa (10 bar). Also available as max. 1.6 MPa (16 bar).
 Liquid temperature: -10 °C to +110 °C (TF 110).
 Specific EEI: 0.19.

Net weights [kg]	Gross weights [kg]	Ship. vol. [m³]
36.9	45.8	0.06

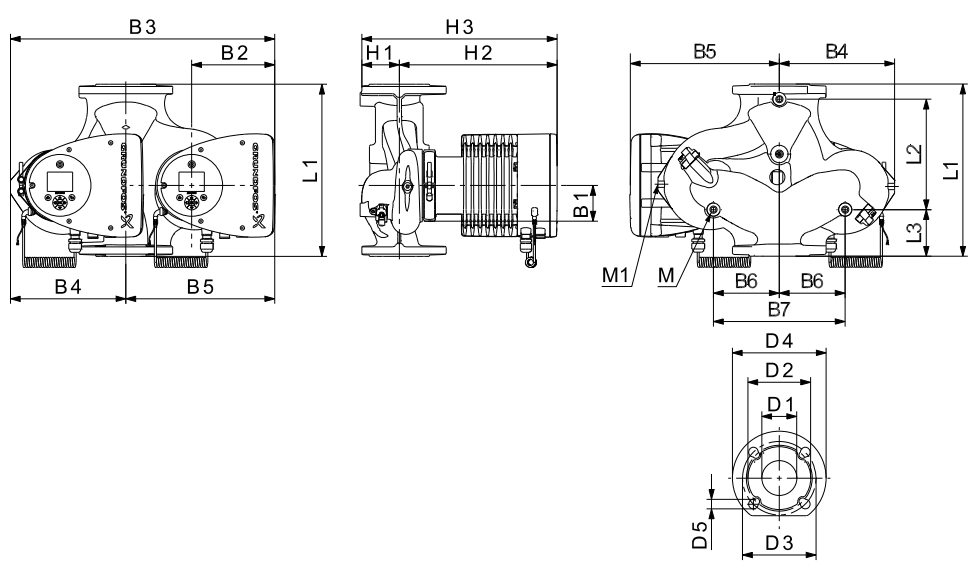

TM05 2205 3612

Pump type	Dimensions [mm]																				
	L1	L2	L3	L4	L5	B1	B3	B4	B5	B6	B7	H1	H2	H3	D1	D2	D3	D4	D5	M	M1
MAGNA3 D 65-40 F	340	218	92	92	204	84	522	228	294	130	260	77	312	389	65	119	130/145	185	14/19	M12	Rp 1/4

For product numbers, see page 106.

MAGNA3 65-60 F (N)

1 x 230 V, 50/60 Hz

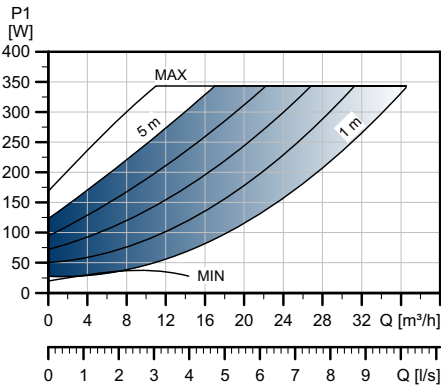
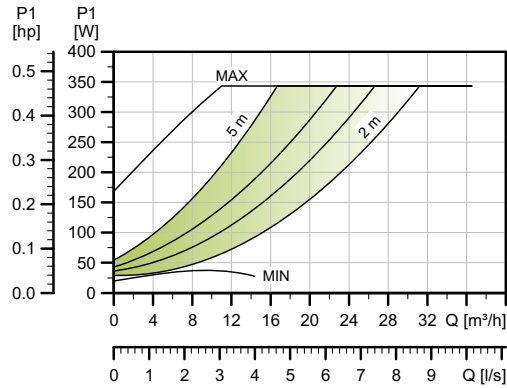
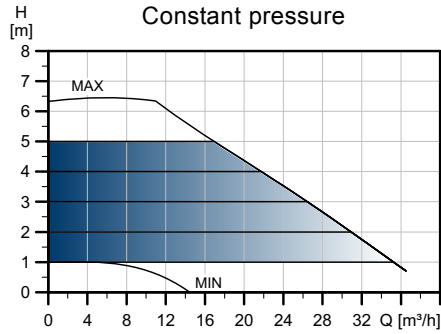
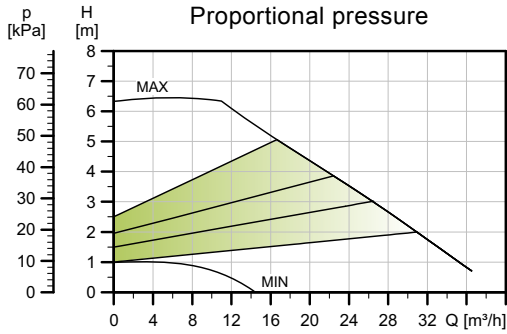

TM05 3747 1912

Speed	P1 [W]	I _{1/I1} [A]
Min.	20	0.22
Max.	350	1.57

The pump incorporates overload protection.

Net weights [kg]	Gross weights [kg]	Ship. vol. [m³]
20.2	23.8	0.06

Connections:

System pressure:

Liquid temperature:

Also available with:

Specific EEI:

See *Counter flanges*, page 39.

Max. 1.0 MPa (10 bar).

Also available as max. 1.6 MPa (16 bar).

-10 °C to +110 °C (TF 110).

Stainless-steel pump housing, type N.

0.18.

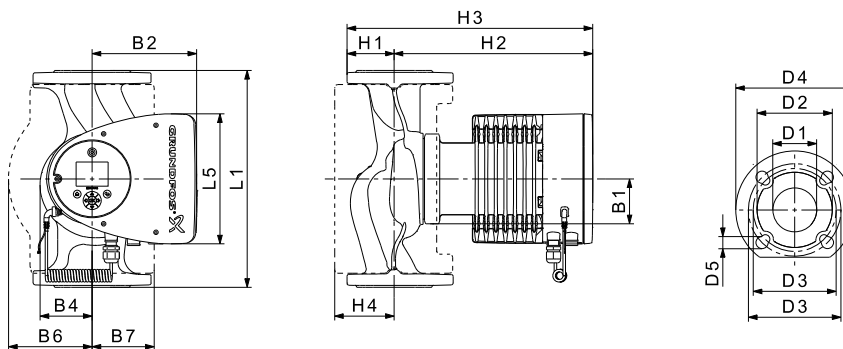

TM05 2204 3612

Pump type	Dimensions [mm]															
	L1	L5	B1	B2	B4	B6	B7	H1	H2	H3	H4	D1	D2	D3	D4	D5
MAGNA3 65-60 F (N)	340	204	84	164	73	133	133	74	312	386	94	65	119	130/145	185	14/19

For product numbers, see page 106.

MAGNA3 D 65-60 F

1 x 230 V, 50/60 Hz

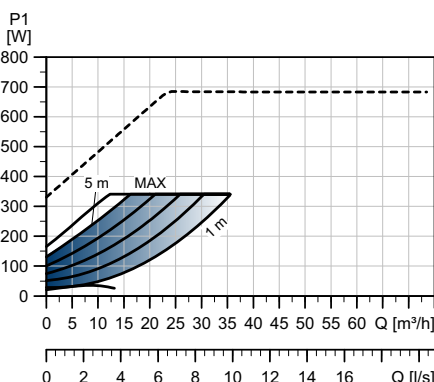
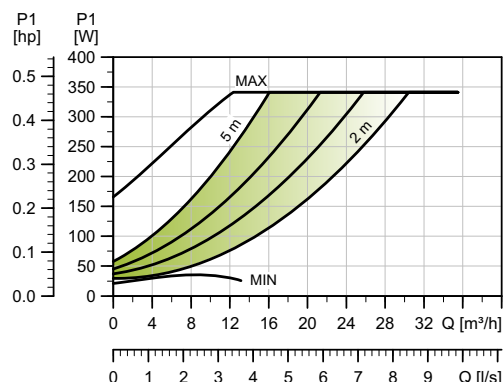
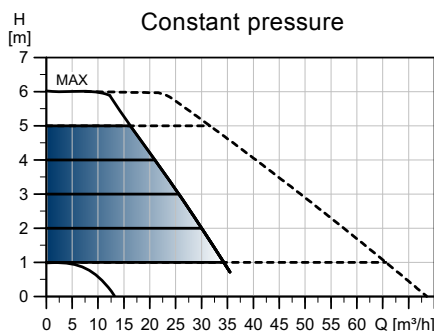
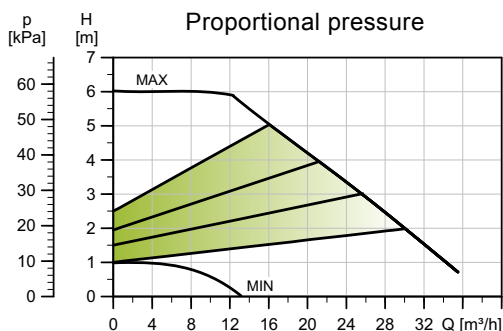

TM05 3772 1912

Speed	P1 [W]	I _{1/1} [A]
Min.	21	0.23
Max.	352	1.57

The pump incorporates overload protection.

Net weights [kg]	Gross weights [kg]	Ship. vol. [m ³]
36.9	45.8	0.06

Connections: See *Counter flanges*, page 39.
 System pressure: Max. 1.0 MPa (10 bar). Also available as max. 1.6 MPa (16 bar).
 Liquid temperature: -10 °C to +110 °C (TF 110).
 Specific EEI: 0.18.

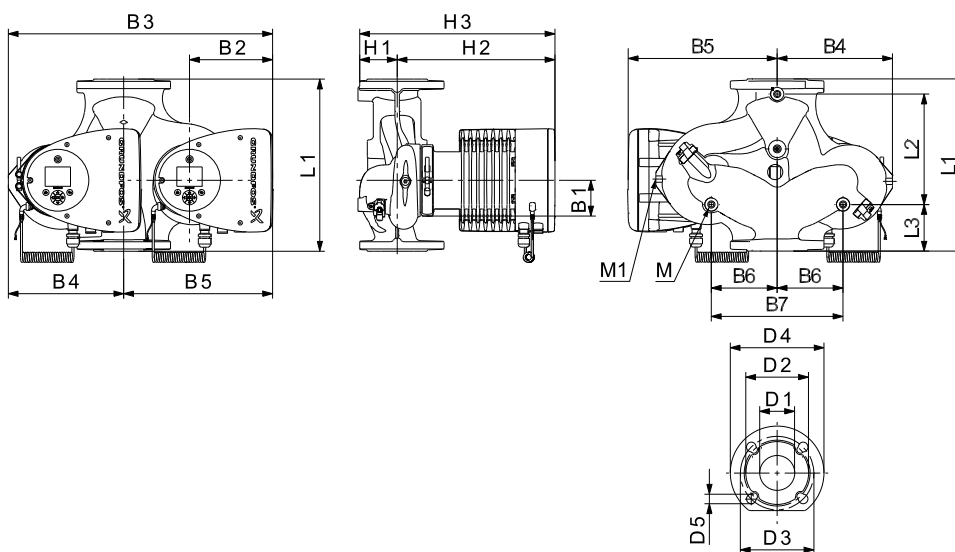

TM05 2205 3612

Pump type	Dimensions [mm]																				
	L1	L2	L3	L4	L5	B1	B3	B4	B5	B6	B7	H1	H2	H3	D1	D2	D3	D4	D5	M	M1
MAGNA3 D 65-60 F	340	218	92	92	204	84	522	228	294	130	260	77	312	389	65	119	130/145	185	14/19	M12	Rp 1/4

For product numbers, see page 106.

MAGNA3 65-80 F (N)

1 x 230 V, 50/60 Hz

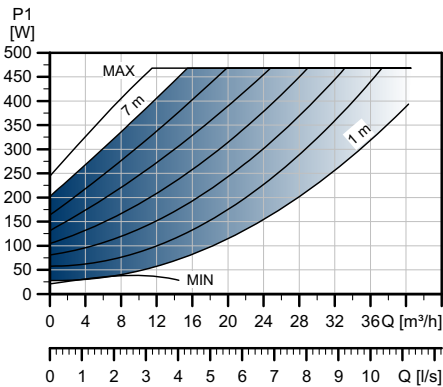
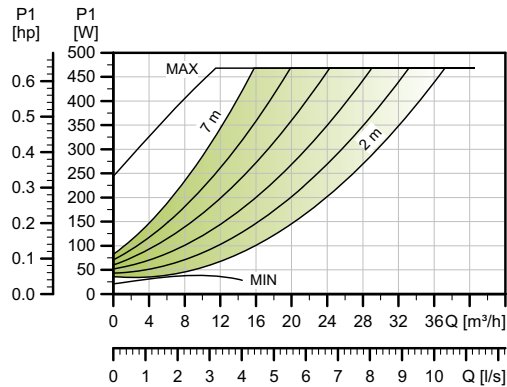
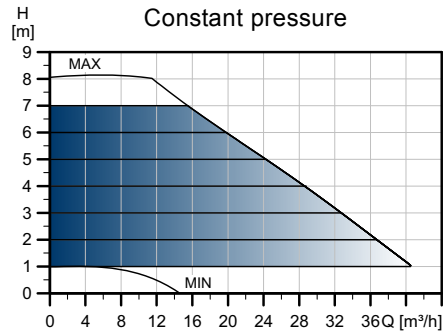
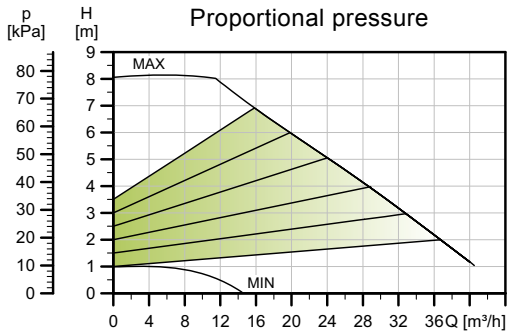

TM05 3748 1912

Speed	P1 [W]	I _{1/I1} [A]
Min.	22	0.24
Max.	478	2.12

The pump incorporates overload protection.

Net weights [kg]	Gross weights [kg]	Ship. vol. [m ³]
21.0	24.7	0.06

Connections:

See *Counter flanges*, page 39.

System pressure:

Max. 1.0 MPa (10 bar).
Also available as max. 1.6 MPa (16 bar).

Liquid temperature:

-10 °C to +110 °C (TF 110).

Also available with:

Stainless-steel pump housing, type N.
Specific EEI: 0.17.

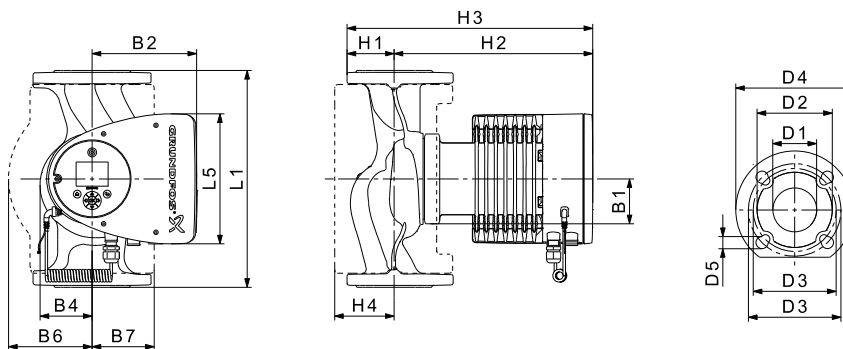

TM05 2204 3612

Pump type	Dimensions [mm]															
	L1	L5	B1	B2	B4	B6	B7	H1	H2	H3	H4	D1	D2	D3	D4	D5
MAGNA3 65-80 F (N)	340	204	84	164	73	133	133	74	312	386	94	65	119	130/145	185	14/19

For product numbers, see page 106.

MAGNA3 D 65-80 F

1 x 230 V, 50/60 Hz

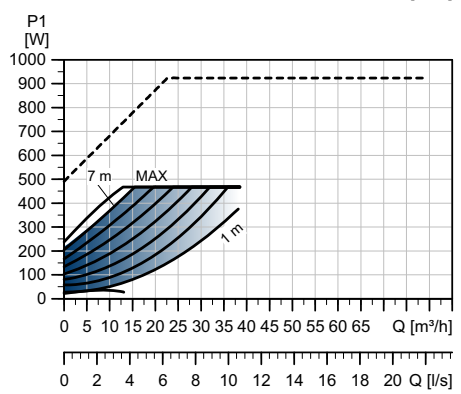
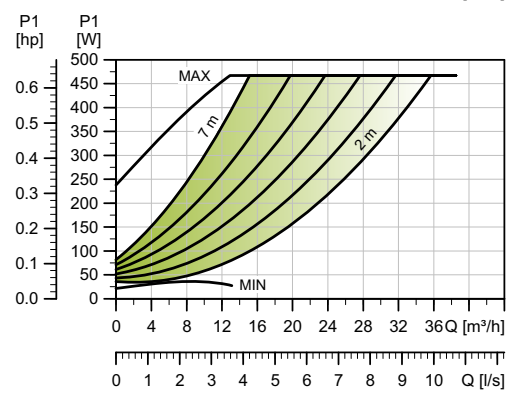
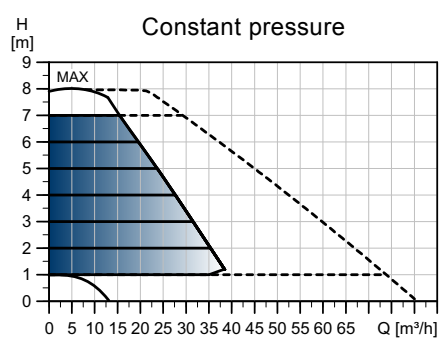
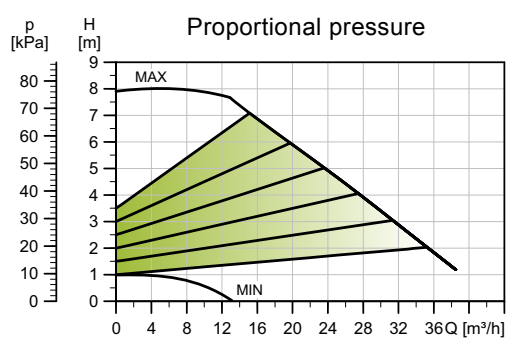

TM05 3773 1912

Speed	P1 [W]	I _{1/1} [A]
Min.	22	0.24
Max.	478	2.12

The pump incorporates overload protection.

Connections: See Counter flanges, page 39.
 System pressure: Max. 1.0 MPa (10 bar). Also available as max. 1.6 MPa (16 bar).
 Liquid temperature: -10 °C to +110 °C (TF 110).
 Specific EEI: 0.17.

Net weights [kg]	Gross weights [kg]	Ship. vol. [m ³]
38.7	47.6	0.06

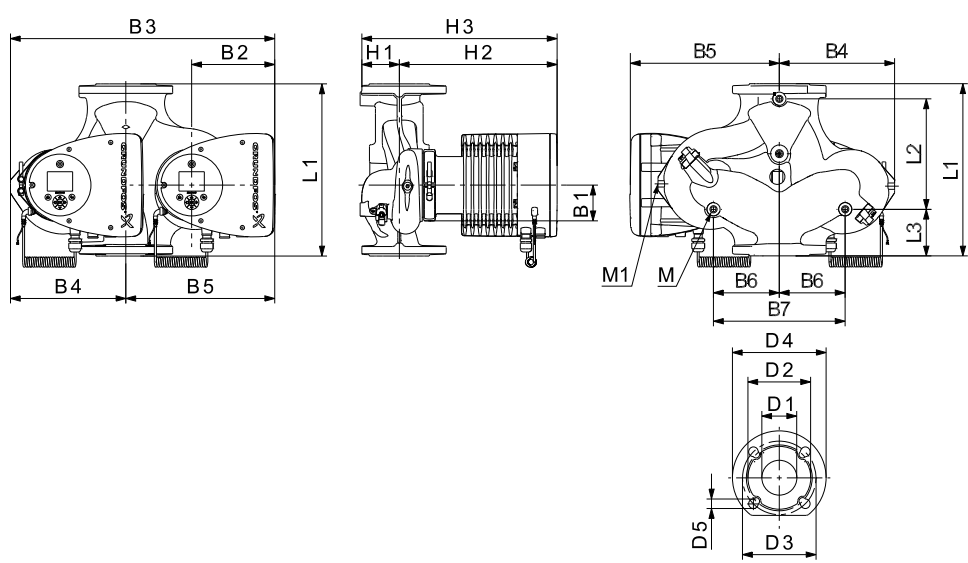

TM05 2205 3612

Pump type	Dimensions [mm]																				
	L1	L2	L3	L4	L5	B1	B3	B4	B5	B6	B7	H1	H2	H3	D1	D2	D3	D4	D5	M	M1
MAGNA3 D 65-80 F	340	218	92	92	204	84	522	228	294	130	260	77	312	389	65	119	130/145	185	14/19	M12	Rp 1/4

For product numbers, see page 106.

MAGNA3 65-100 F (N)

1 x 230 V, 50/60 Hz

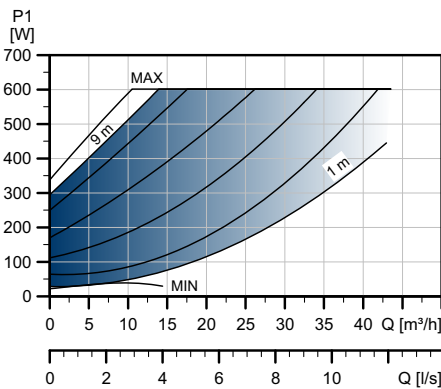
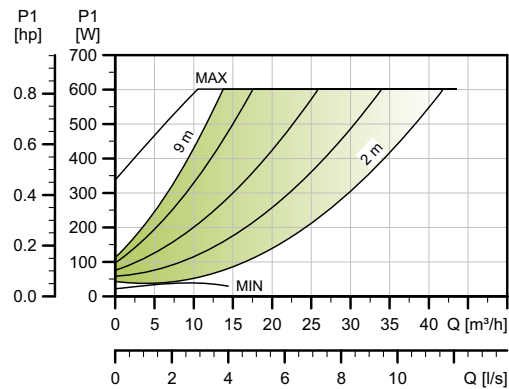
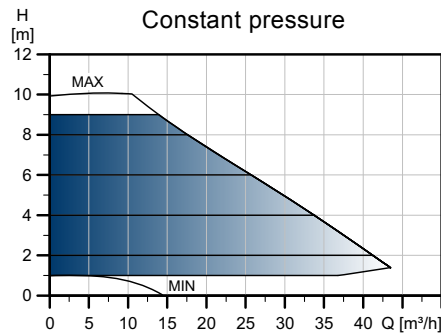
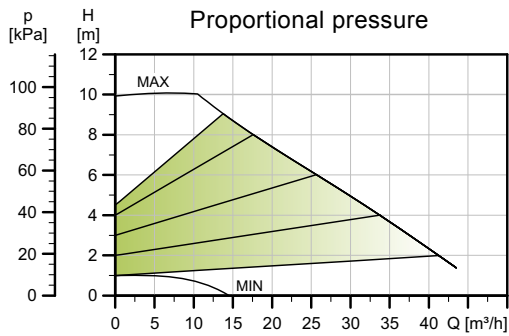

TM05 3749 1912

Speed	P1 [W]	I _{1/I1} [A]
Min.	21	0.23
Max.	613	2.70

The pump incorporates overload protection.

Net weights [kg]	Gross weights [kg]	Ship. vol. [m ³]
21.0	24.7	0.06

Connections: See *Counter flanges*, page 39.
 System pressure: Max. 1.0 MPa (10 bar).
 Also available as max. 1.6 MPa (16 bar).
 Liquid temperature: -10 °C to +110 °C (TF 110).
 Also available with: Stainless-steel pump housing, type N.
 Specific EEI: 0.17.

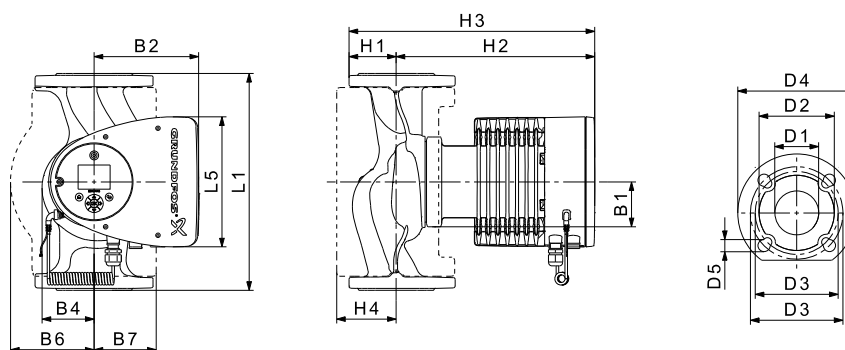

TM05 2204 3612

Pump type	Dimensions [mm]															
	L1	L5	B1	B2	B4	B6	B7	H1	H2	H3	H4	D1	D2	D3	D4	D5
MAGNA3 65-100 F (N)	340	204	84	164	73	133	133	74	312	386	94	65	119	130/145	185	14/19

For product numbers, see page 106.

MAGNA3 D 65-100 F

1 x 230 V, 50/60 Hz

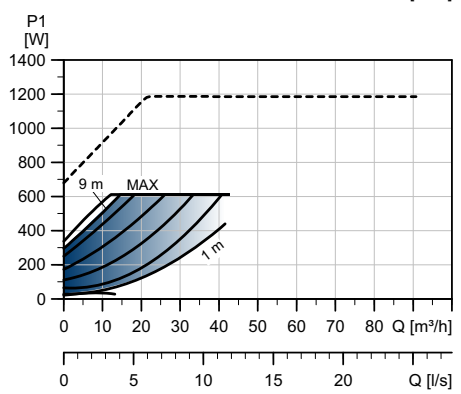
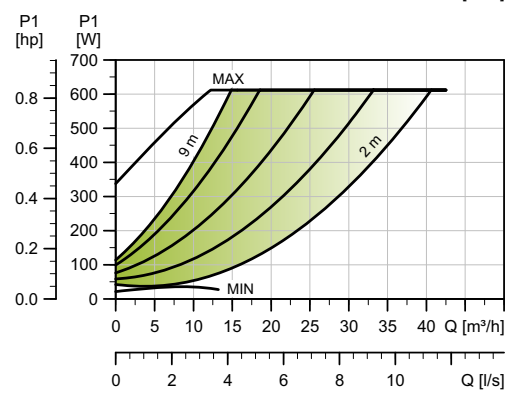
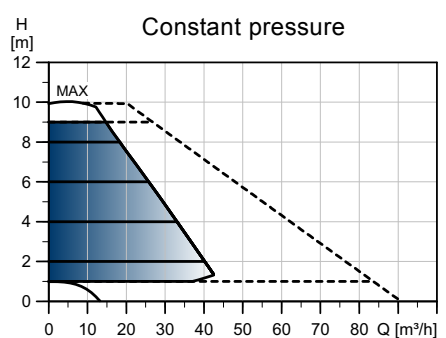
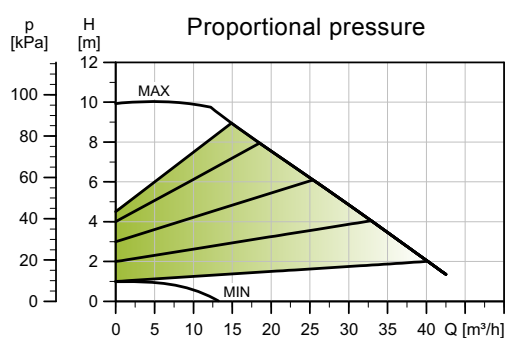

TM05 2205 3612

Speed	P1 [W]	I _{1/1} [A]
Min.	23	0.24
Max.	613	2.97

The pump incorporates overload protection.

Connections: See Counter flanges, page 39.
 System pressure: Max. 1.0 MPa (10 bar). Also available as max. 1.6 MPa (16 bar).
 Liquid temperature: -10 °C to +110 °C (TF 110).
 Specific EEI: 0.17.

Net weights [kg]	Gross weights [kg]	Ship. vol. [m ³]
38.7	47.6	0.06

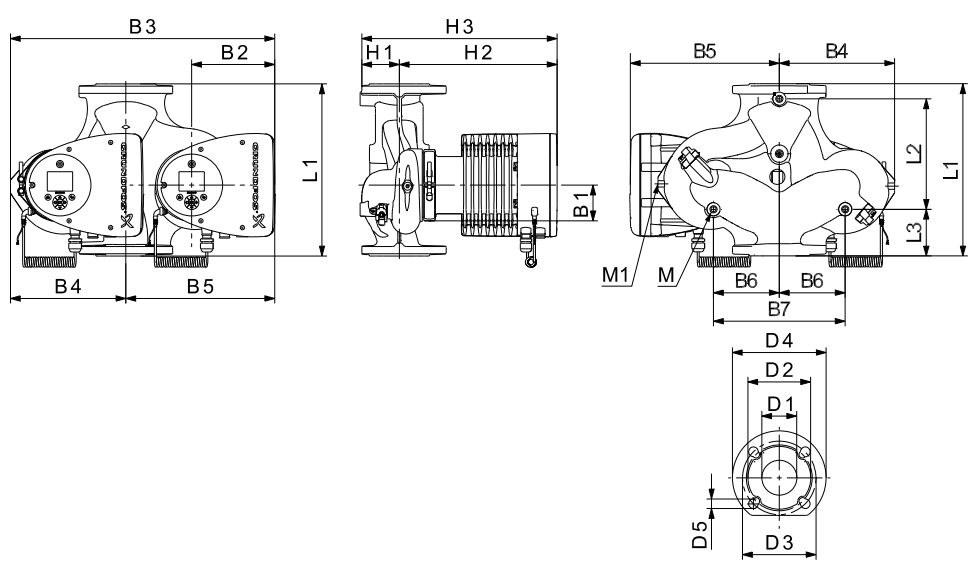

TM05 2205 0412

Pump type	Dimensions [mm]																				
	L1	L2	L3	L4	L5	B1	B3	B4	B5	B6	B7	H1	H2	H3	D1	D2	D3	D4	D5	M	M1
MAGNA3 D 65-100 F	340	218	92	92	204	84	522	228	294	130	260	77	312	389	65	119	130/145	185	14/19	M12	Rp 1/4

For product numbers, see page 106.

MAGNA3 65-120 F (N)

1 x 230 V, 50/60 Hz

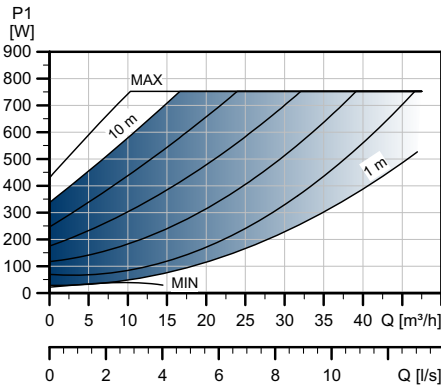
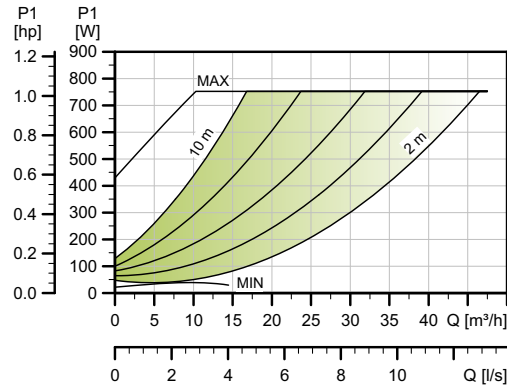
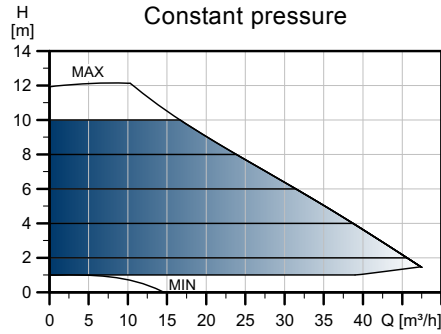
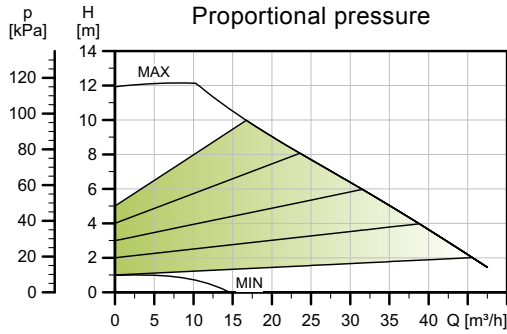

TM05 3750 1912

Speed	P1 [W]	I _{1/I1} [A]
Min.	16	0.18
Max.	769	3.38

The pump incorporates overload protection.

Net weights [kg]	Gross weights [kg]	Ship. vol. [m ³]
21.0	24.7	0.06

Connections: See *Counter flanges*, page 39.
 System pressure: Max. 1.0 MPa (10 bar). Also available as max. 1.6 MPa (16 bar).
 Liquid temperature: -10 °C to +110 °C (TF 110).
 Also available with: Stainless-steel pump housing, type N.
 Specific EEI: 0.17.

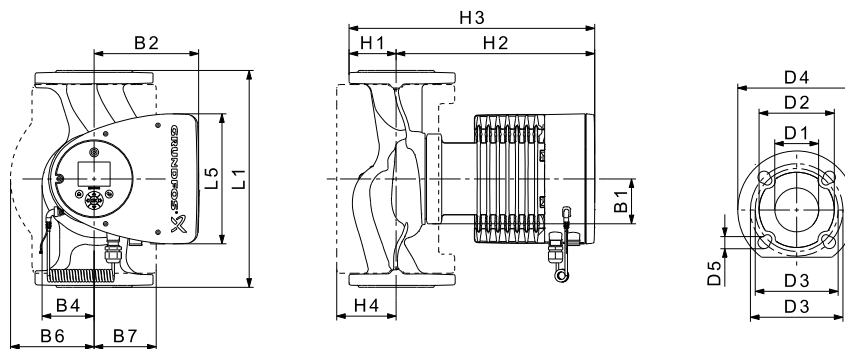

TM05 2204 3612

Pump type	Dimensions [mm]															
	L1	L5	B1	B2	B4	B6	B7	H1	H2	H3	H4	D1	D2	D3	D4	D5
MAGNA3 65-120 F (N)	340	204	84	164	73	133	133	74	312	386	94	65	119	130/145	185	14/19

For product numbers, see page 106.

MAGNA3 D 65-120 F

1 x 230 V, 50/60 Hz

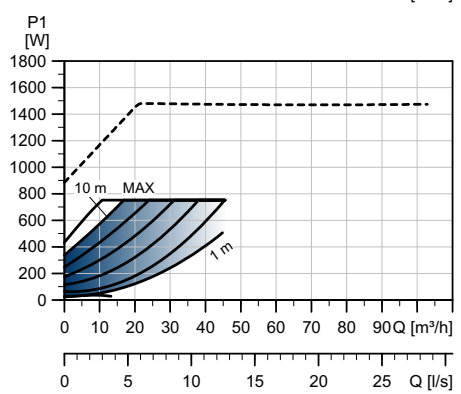
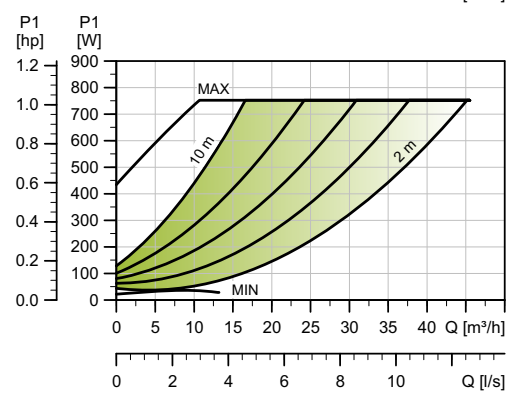
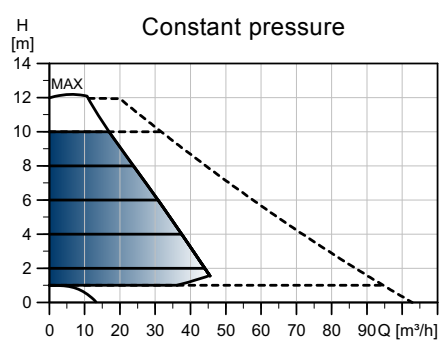
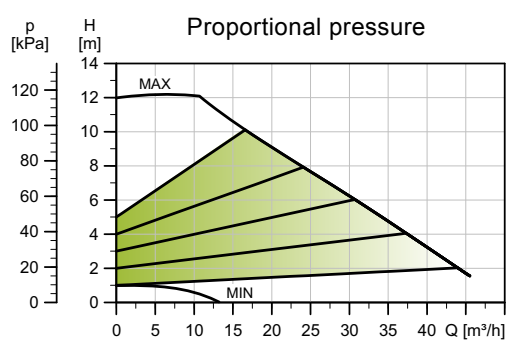

TM05 3775 1912

Speed	P1 [W]	I _{1/I1} [A]
Min.	23	0.24
Max.	760	3.36

The pump incorporates overload protection.

Connections: See Counter flanges, page 39.
 System pressure: Max. 1.0 MPa (10 bar). Also available as max. 1.6 MPa (16 bar).
 Liquid temperature: -10 °C to +110 °C (TF 110).
 Specific EEI: 0.17.

Net weights [kg]	Gross weights [kg]	Ship. vol. [m³]
38.7	47.6	0.06

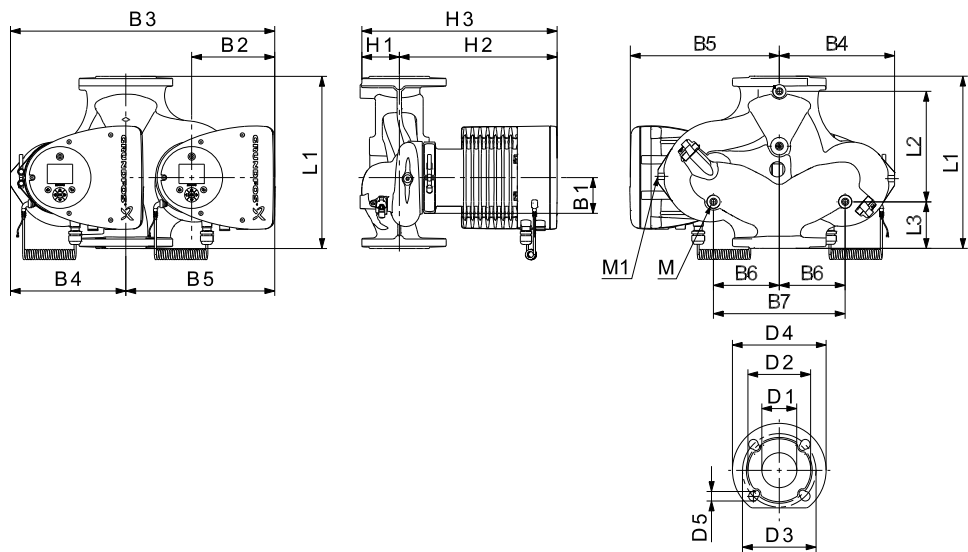

TM05 2205 3612

Pump type	Dimensions [mm]																				
	L1	L2	L3	L4	L5	B1	B3	B4	B5	B6	B7	H1	H2	H3	D1	D2	D3	D4	D5	M	M1
MAGNA3 D 65-120 F	340	218	92	92	204	84	522	228	294	130	260	77	312	389	65	119	130/145	185	14/19	M12	Rp 1/4

For product numbers, see page 106.

MAGNA3 65-150 F (N)

1 x 230 V, 50/60 Hz

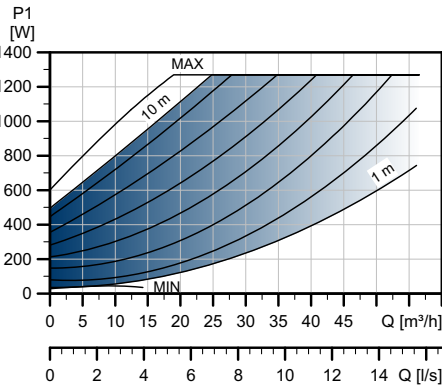
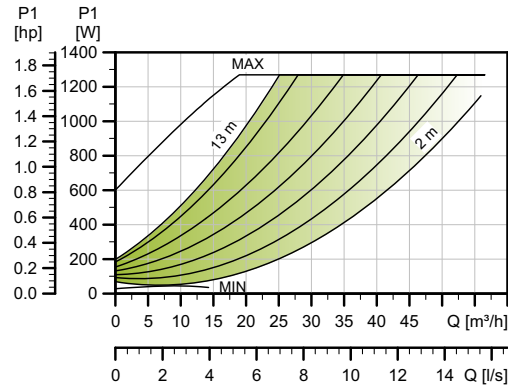
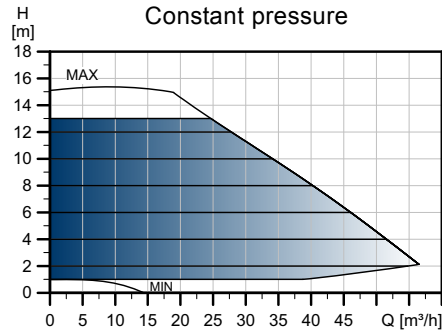
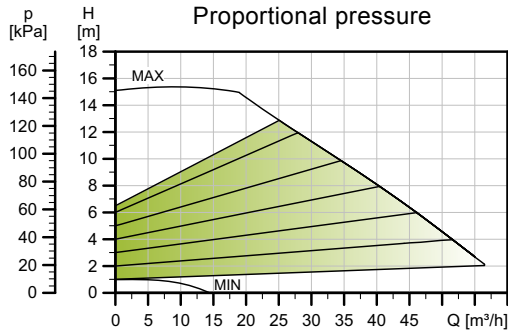

TM05 3751 1912

Speed	P1 [W]	I _{1/1} [A]
Min.	29	0.30
Max.	1301	5.68

The pump incorporates overload protection.

Net weights [kg]	Gross weights [kg]	Ship. vol. [m ³]
24.0	27.8	0.06

Connections: See *Counter flanges*, page 39.
 System pressure: Max. 1.0 MPa (10 bar). Also available as max. 1.6 MPa (16 bar).
 Liquid temperature: -10 °C to +110 °C (TF 110).
 Also available with: Stainless-steel pump housing, type N.
 Specific EEI: 0.17.

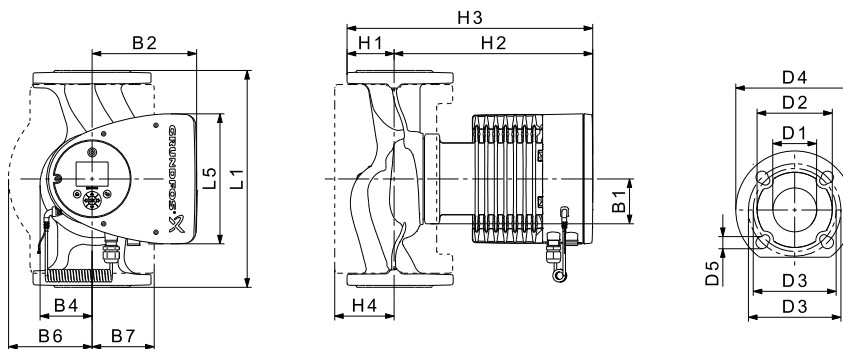

TM05 2204 3612

Pump type	Dimensions [mm]															
	L1	L5	B1	B2	B4	B6	B7	H1	H2	H3	H4	D1	D2	D3	D4	D5
MAGNA3 65-150 F (N)	340	204	84	164	73	133	133	74	312	386	94	65	119	130/145	185	14/19

For product numbers, see page 106.

MAGNA3 D 65-150 F

1 x 230 V, 50/60 Hz

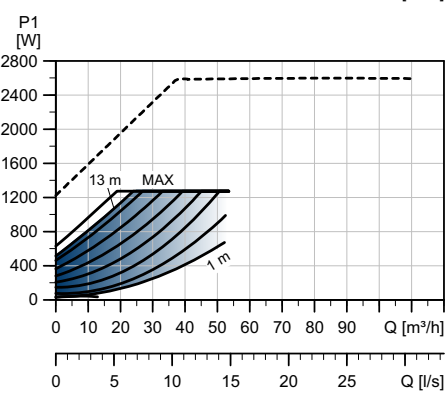
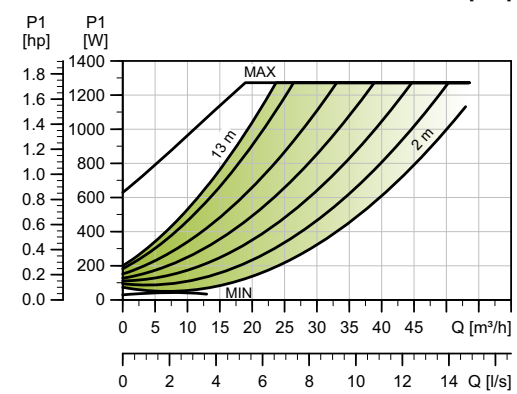
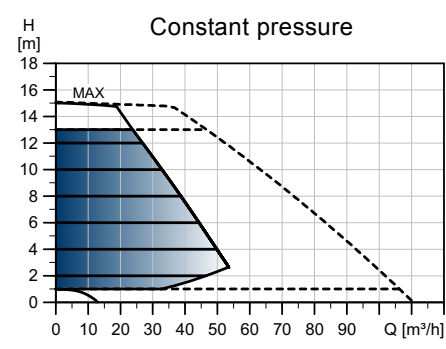
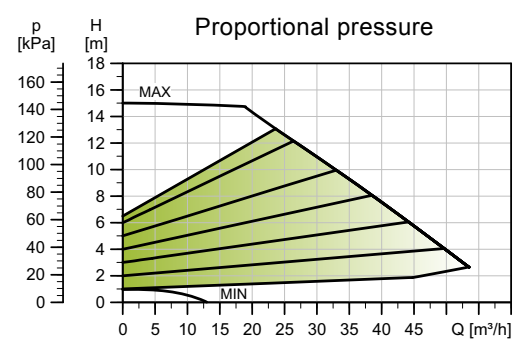

TM05 3776 1912

Speed	P1 [W]	I _{1/1} [A]
Min.	29	0.30
Max.	1301	5.68

The pump incorporates overload protection.

Connections: See Counter flanges, page 39.
 System pressure: Max. 1.0 MPa (10 bar). Also available as max. 1.6 MPa (16 bar).
 Liquid temperature: -10 °C to +110 °C (TF 110).
 Specific EEI: 0.17.

Net weights [kg]	Gross weights [kg]	Ship. vol. [m ³]
44.6	53.7	0.06

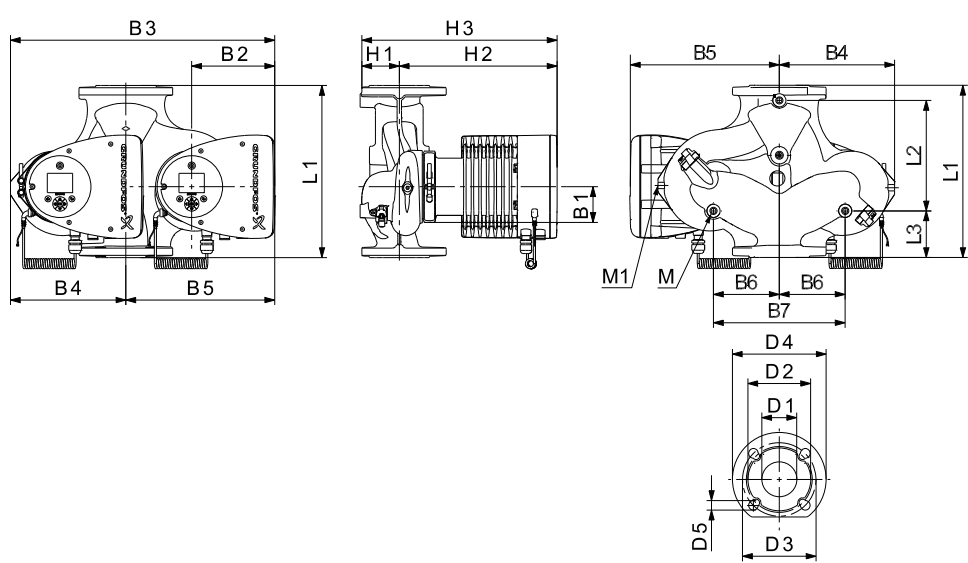

TM05 2205 3612

Pump type	Dimensions [mm]																				
	L1	L2	L3	L4	L5	B1	B3	B4	B5	B6	B7	H1	H2	H3	D1	D2	D3	D4	D5	M	M1
MAGNA3 D 65-150 F	340	218	92	92	204	84	522	228	294	130	260	77	312	389	65	119	130/145	185	14/19	M12	Rp 1/4

For product numbers, see page 106.

MAGNA3 80-40 F

1 x 230 V, 50/60 Hz

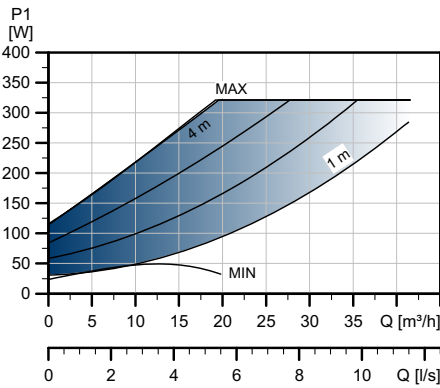
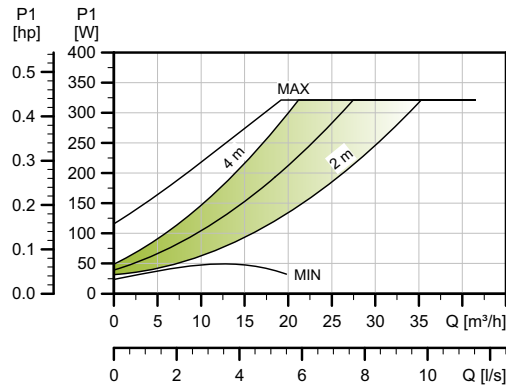
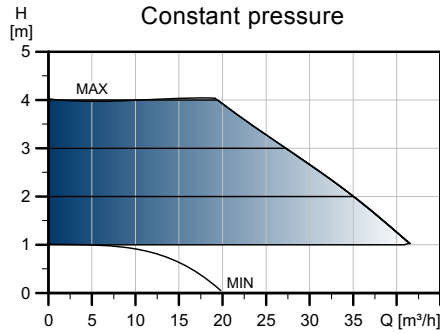
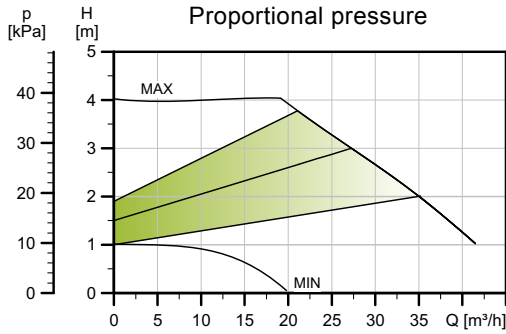

TM05 3752 1912

Speed	P1 [W]	I _{1/1} [A]
Min.	24	0.26
Max.	326	1.47

The pump incorporates overload protection.

Net weights [kg]	Gross weights [kg]	Ship. vol. [m ³]
25.8	28.8	0.07

Connections: See Counter flanges, page 39.
 System pressure: Max. 1.0 MPa (10 bar). Also available as max. 1.6 MPa (16 bar).
 Liquid temperature: -10 °C to +110 °C (TF 110).
 Specific EEI: 0.17.

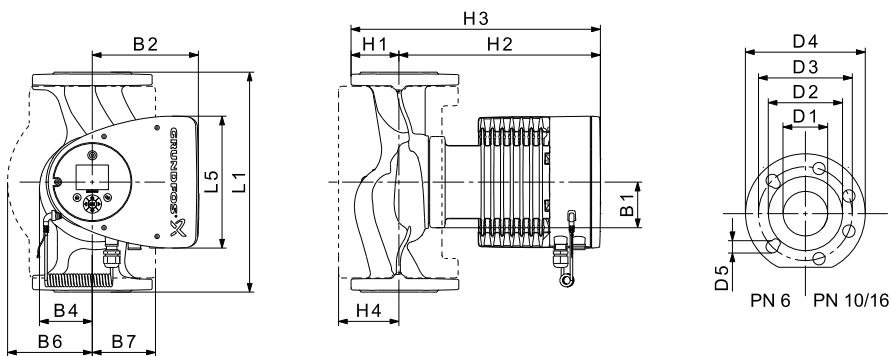

TM05 5291 3612

Pump type	Dimensions [mm]															
	L1	L5	B1	B2	B4	B6	B7	H1	H2	H3	H4	D1	D2	D3	D4	D5
MAGNA3 80-40 F	360	204	84	164	73	163	163	96	318	413	115	80	128	150/160	200	19

For product numbers, see page 106.

MAGNA3 D 80-40 F

1 x 230 V, 50/60 Hz

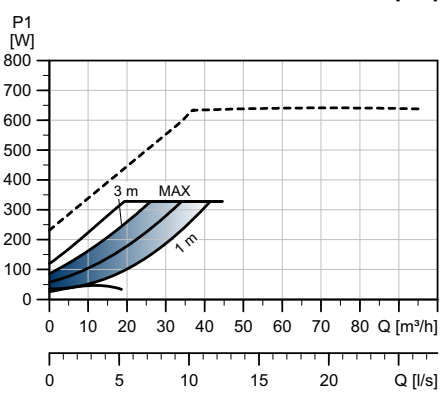
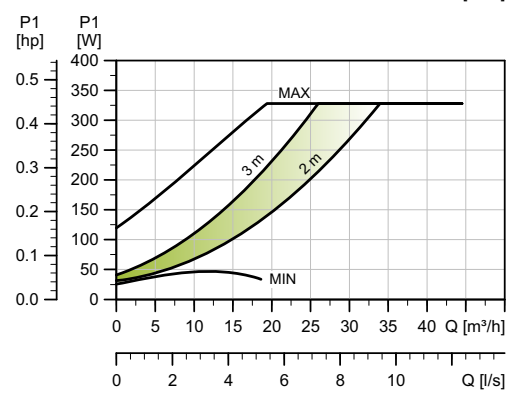
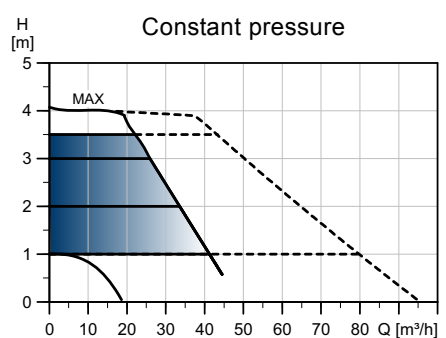
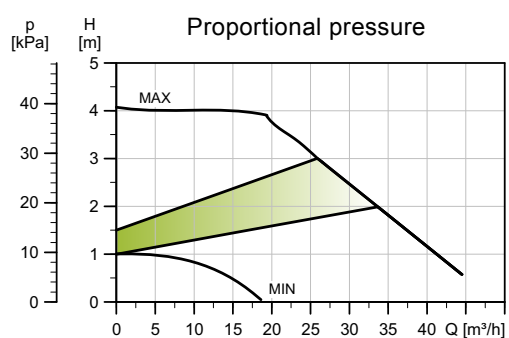

TM05 3777 1912

Speed	P1 [W]	I _{1/1} [A]
Min.	26	0.28
Max.	333	1.50

The pump incorporates overload protection.

Connections: See Counter flanges, page 39.
 System pressure: Max. 1.0 MPa (10 bar). Also available as max. 1.6 MPa (16 bar).
 Liquid temperature: -10 °C to +110 °C (TF 110).
 Specific EEI: 0.19.

Net weights [kg]	Gross weights [kg]	Ship. vol. [m ³]
45.8	55.8	0.07

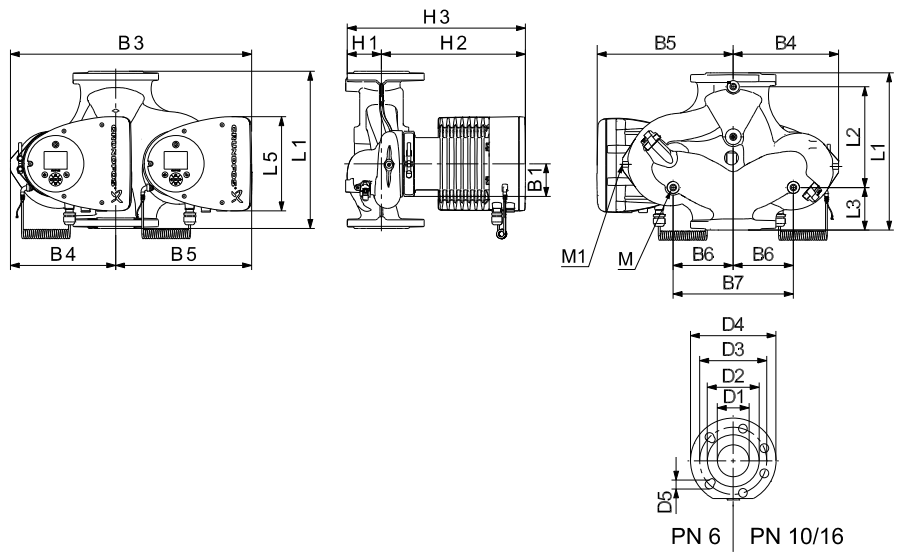

TM05 5366 3612

Pump type	Dimensions [mm]																				
	L1	L2	L3	L4	L5	B1	B3	B4	B5	B6	B7	H1	H2	H3	D1	D2	D3	D4	D5	M	M1
MAGNA3 D 80-40 F	360	218	102	102	204	84	538	244	294	130	260	97	318	415	80	128	150/160	200	19	M12	Rp 1/4

For product numbers, see page 106.

MAGNA3 80-60 F

1 x 230 V, 50/60 Hz

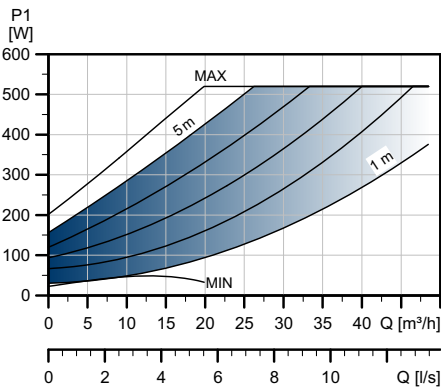
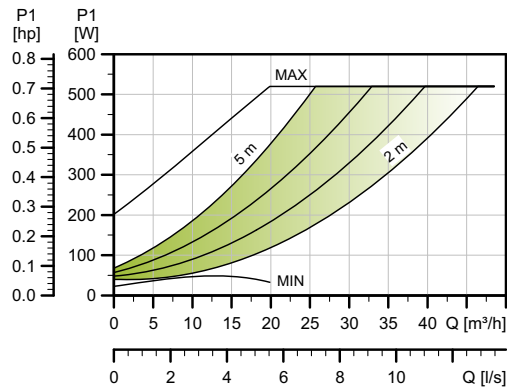
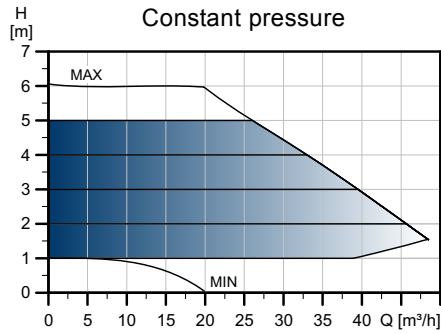
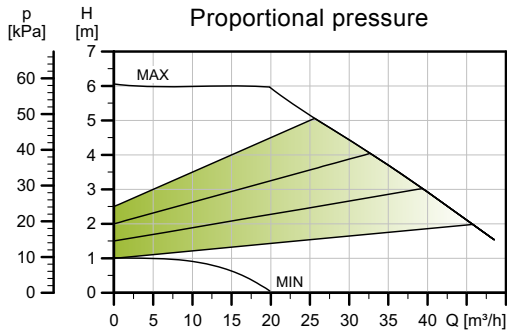

TM05 3753 1912

Speed	P1 [W]	I _{1/1} [A]
Min.	24	0.26
Max.	530	2.35

The pump incorporates overload protection.

Connections: See *Counter flanges*, page 39.
 System pressure: Max. 1.0 MPa (10 bar). Also available as max. 1.6 MPa (16 bar).
 Liquid temperature: -10 °C to +110 °C (TF 110).
 Specific EEI: 0.17.

Net weights [kg]	Gross weights [kg]	Ship. vol. [m ³]
25.8	29.1	0.07

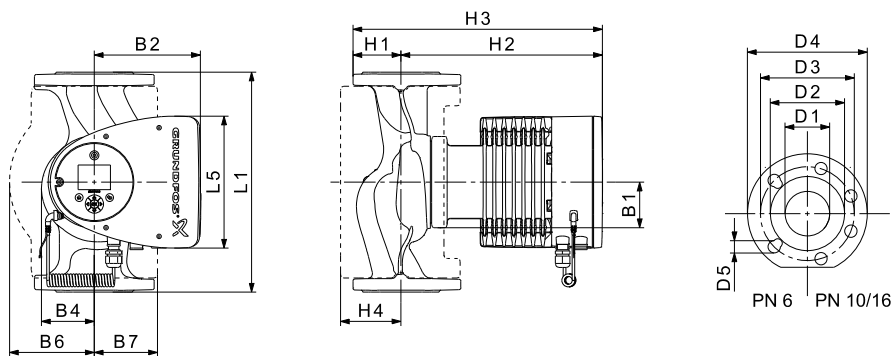

TM05 5291 3612

Pump type	Dimensions [mm]															
	L1	L5	B1	B2	B4	B6	B7	H1	H2	H3	H4	D1	D2	D3	D4	D5
MAGNA3 80-60 F	360	204	84	164	73	163	163	96	318	413	115	80	128	150/160	200	19

For product numbers, see page 106.

MAGNA3 D 80-60 F

1 x 230 V, 50/60 Hz

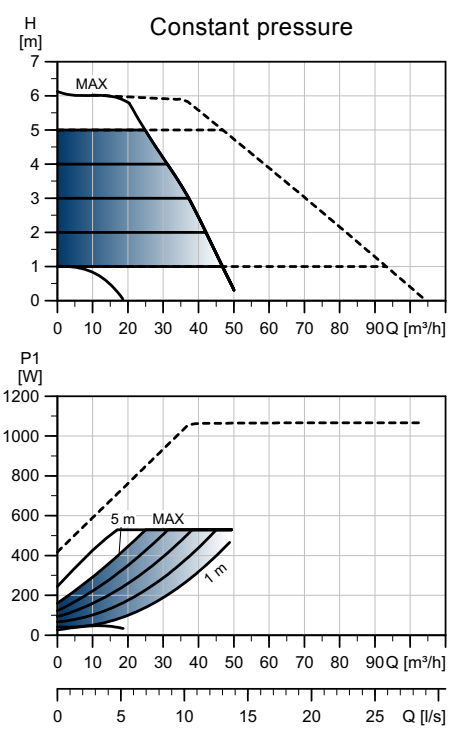
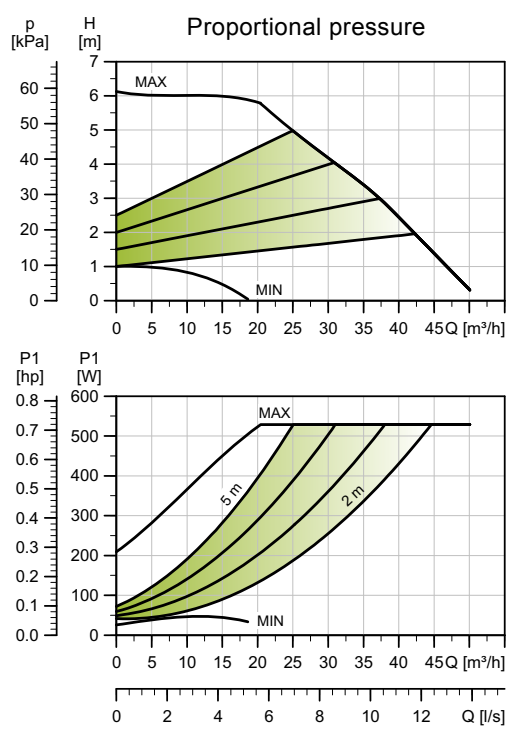

TM05 3778 1912

Speed	P1 [W]	I _{1/1} [A]
Min.	26	0.28
Max.	540	2.39

The pump incorporates overload protection.

Net weights [kg]	Gross weights [kg]	Ship. vol. [m³]
45.8	55.8	0.07

Connections: See Counter flanges, page 39.
 System pressure: Max. 1.0 MPa (10 bar). Also available as max. 1.6 MPa (16 bar).
 Liquid temperature: -10 °C to +110 °C (TF 110).
 Specific EEI: 0.18.

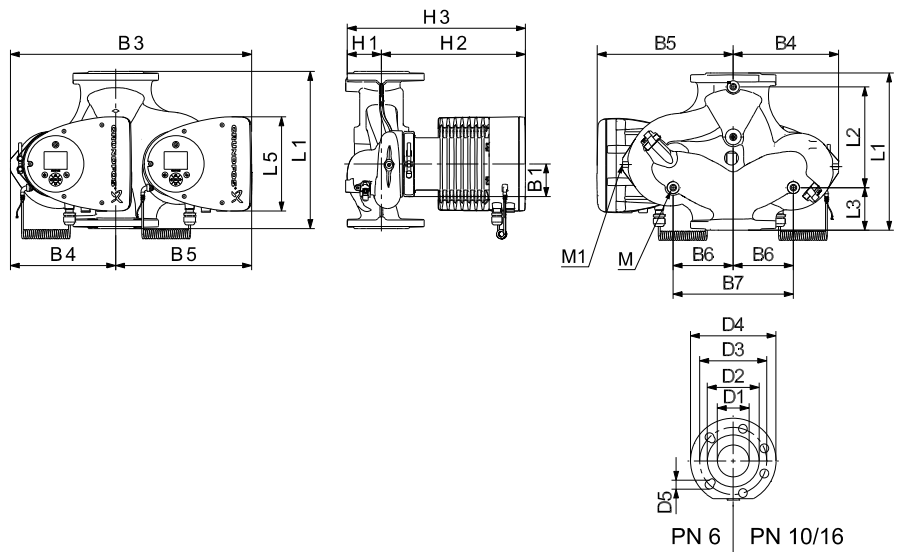

TM05 5366 3612

Pump type	Dimensions [mm]																				
	L1	L2	L3	L4	L5	B1	B3	B4	B5	B6	B7	H1	H2	H3	D1	D2	D3	D4	D5	M	M1
MAGNA3 D 80-60 F	360	218	102	102	204	84	538	244	294	130	260	97	318	415	80	128	150/160	200	19	M12	Rp 1/4

For product numbers, see page 106.

MAGNA3 80-80 F

1 x 230 V, 50/60 Hz

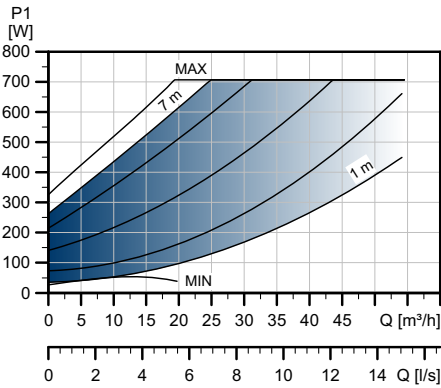
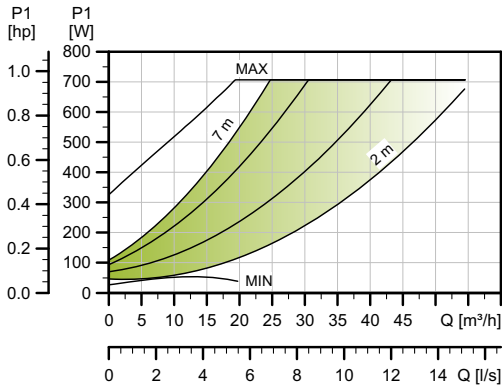
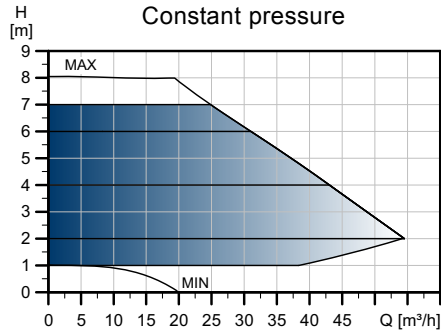
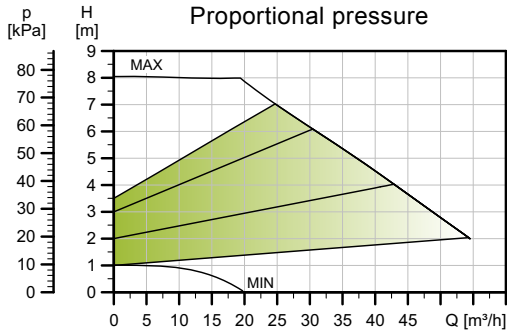

TM05 3754 1912

Speed	P1 [W]	I _{1/1} [A]
Min.	28	0.28
Max.	721	3.17

The pump incorporates overload protection.

Net weights [kg]	Gross weights [kg]	Ship. vol. [m ³]
28.0	32.0	0.07

Connections: See Counter flanges, page 39.
 System pressure: Max. 1.0 MPa (10 bar).
 Also available as max. 1.6 MPa (16 bar).
 Liquid temperature: -10 °C to +110 °C (TF 110).
 Specific EEI: 0.17.

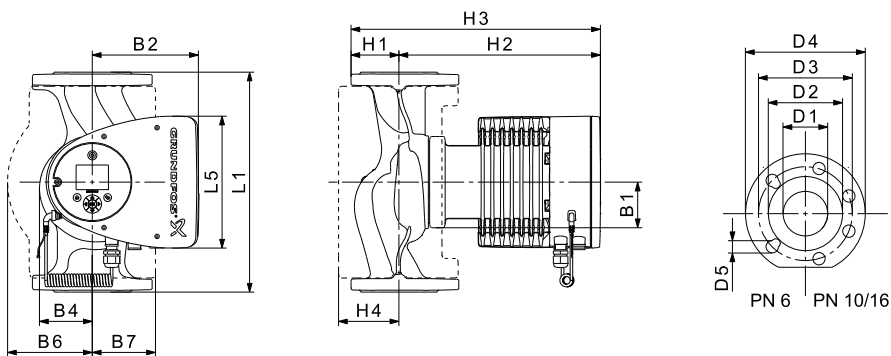

TM05 5291 3612

Pump type	Dimensions [mm]															
	L1	L5	B1	B2	B4	B6	B7	H1	H2	H3	H4	D1	D2	D3	D4	D5
MAGNA3 80-80 F	360	204	84	164	73	163	163	96	318	413	115	80	128	150/160	200	19

For product numbers, see page 106.

MAGNA3 D 80-80 F

1 x 230 V, 50/60 Hz

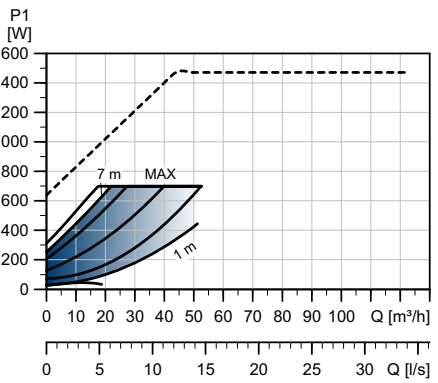
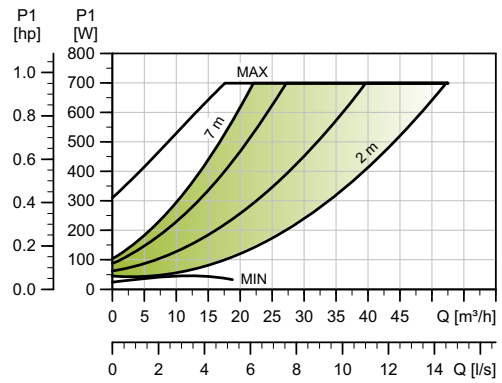
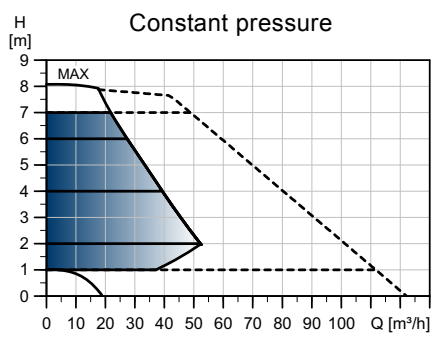
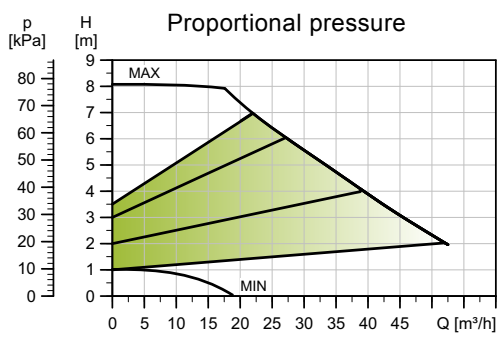

TM05 3778 1912

Speed	P1 [W]	I _{1/1} [A]
Min.	26	0.28
Max.	540	2.39

The pump incorporates overload protection.

Net weights [kg]	Gross weights [kg]	Ship. vol. [m ³]
45.8	55.8	0.07

Connections: See Counter flanges, page 39.
 System pressure: Max. 1.0 MPa (10 bar). Also available as max. 1.6 MPa (16 bar).
 Liquid temperature: -10 °C to +110 °C (TF 110).
 Specific EEI: 0.18.

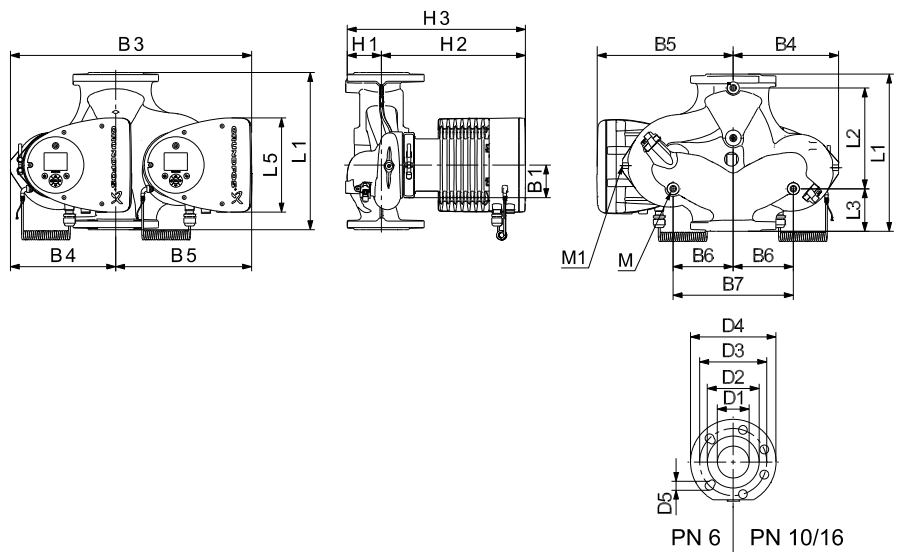

TM05 5366 3612

Pump type	Dimensions [mm]																				
	L1	L2	L3	L4	L5	B1	B3	B4	B5	B6	B7	H1	H2	H3	D1	D2	D3	D4	D5	M	M1
MAGNA3 D 80-80 F	360	218	102	102	204	84	538	244	294	130	260	97	318	415	80	128	150/160	200	19	M12	Rp 1/4

For product numbers, see page 106.

MAGNA3 80-100 F

1 x 230 V, 50/60 Hz

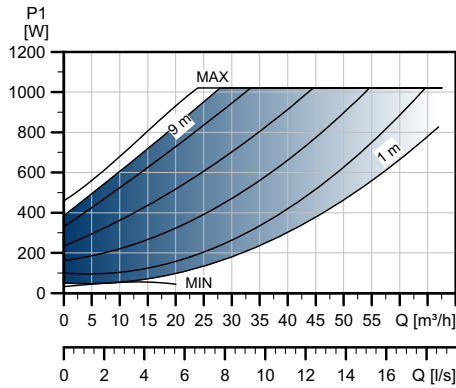
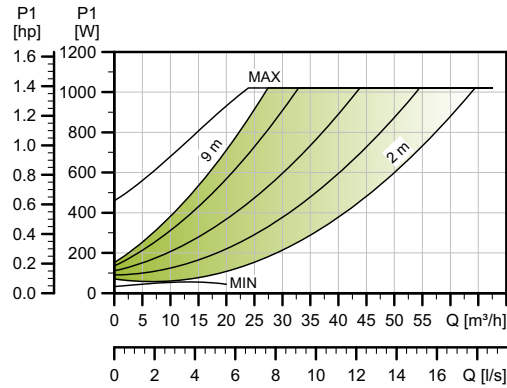
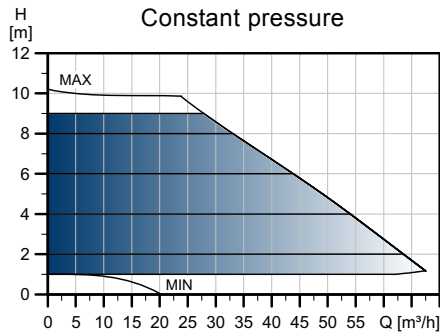
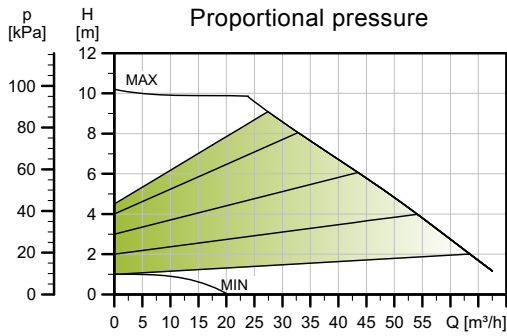

TM05 3755 1912

Speed	P1 [W]	I _{1/1} [A]
Min.	31	0.32
Max.	1041	4.60

The pump incorporates overload protection.

Net weights [kg]	Gross weights [kg]	Ship. vol. [m ³]
28.8	32.6	0.07

Connections: See *Counter flanges*, page 39.
 System pressure: Max. 1.0 MPa (10 bar). Also available as max. 1.6 MPa (16 bar).
 Liquid temperature: -10 °C to +110 °C (TF 110).
 Specific EEI: 0.17.

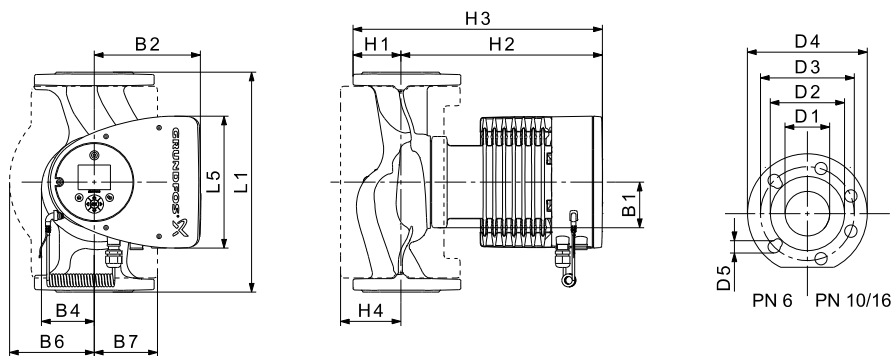

TM05 5291 3612

Pump type	Dimensions [mm]															
	L1	L5	B1	B2	B4	B6	B7	H1	H2	H3	H4	D1	D2	D3	D4	D5
MAGNA3 80-100 F	360	204	84	164	73	163	163	96	318	413	115	80	128	150/160	200	19

For product numbers, see page 106.

MAGNA3 D 80-100 F

1 x 230 V, 50/60 Hz

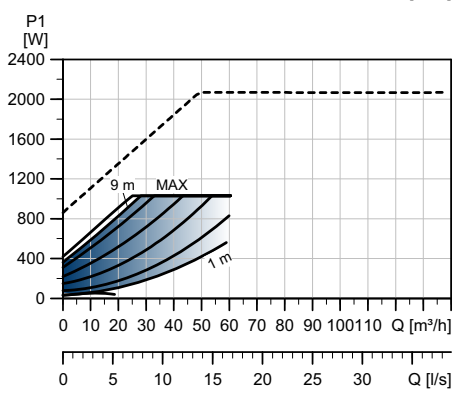
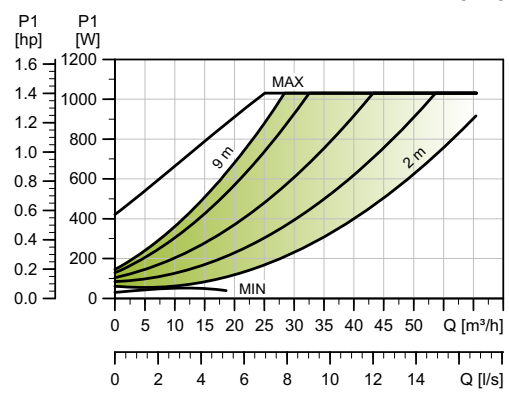
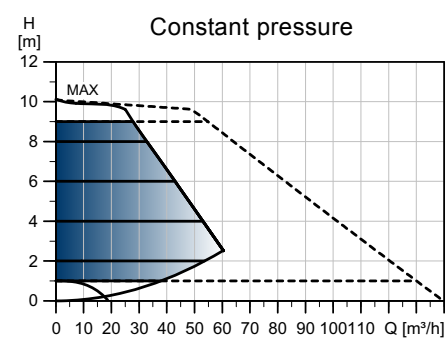
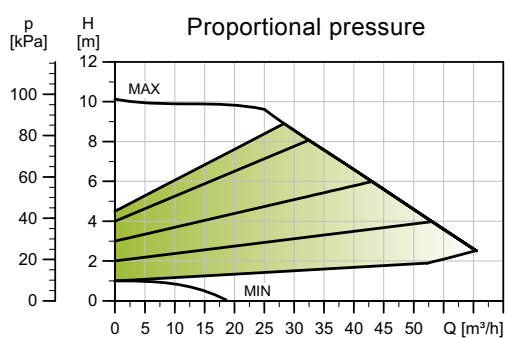

TM05 3780 1912

Speed	P1 [W]	I _{1/1} [A]
Min.	32	0.32
Max.	1052	4.62

The pump incorporates overload protection.

Connections: See Counter flanges, page 39.
 System pressure: Max. 1.0 MPa (10 bar). Also available as max. 1.6 MPa (16 bar).
 Liquid temperature: -10 °C to +110 °C (TF 110).
 Specific EEI: 0.17.

Net weights [kg]	Gross weights [kg]	Ship. vol. [m ³]
51.6	63.4	0.07

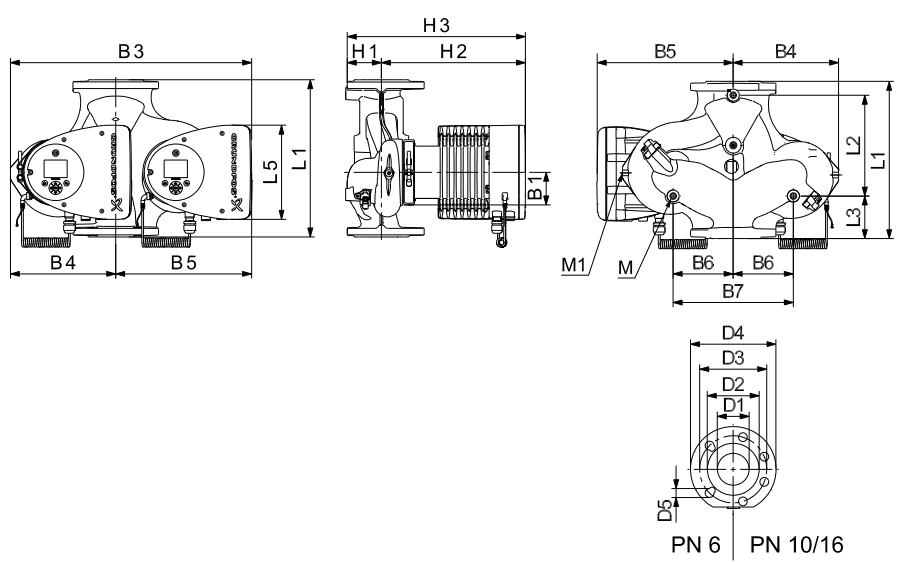

TM05 5366 3612

Pump type	Dimensions [mm]																				
	L1	L2	L3	L4	L5	B1	B3	B4	B5	B6	B7	H1	H2	H3	D1	D2	D3	D4	D5	M	M1
MAGNA3 D 80-100 F	360	218	102	102	204	84	538	244	294	130	260	97	318	415	80	128	150/160	200	19	M12	Rp 1/4

For product numbers, see page 106.

MAGNA3 80-120 F

1 x 230 V, 50/60 Hz

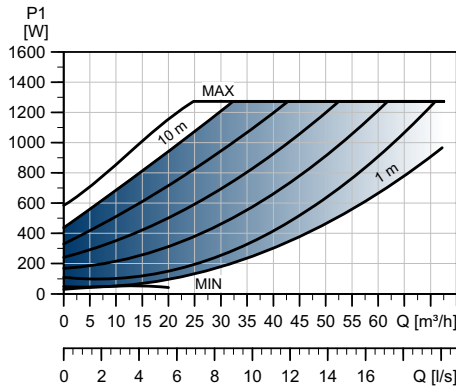
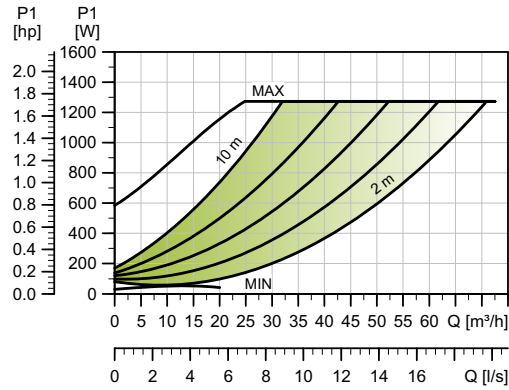
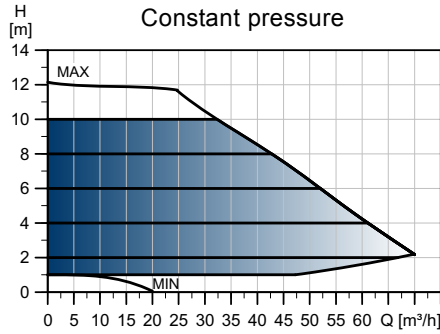
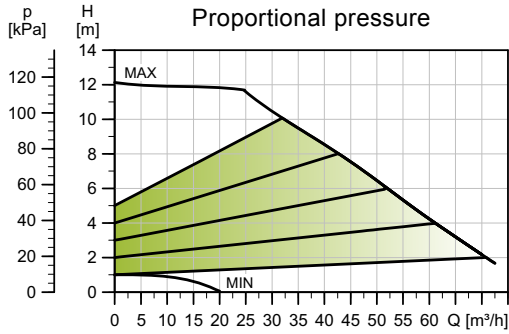

TM05 3756 1912

Speed	P1 [W]	I _{1/1} [A]
Min.	31	0.32
Max.	1297	5.72

The pump incorporates overload protection.

Net weights [kg]	Gross weights [kg]	Ship. vol. [m ³]
28.8	32.6	0.07

Connections: See *Counter flanges*, page 39.
 System pressure: Max. 1.0 MPa (10 bar). Also available as max. 1.6 MPa (16 bar).
 Liquid temperature: -10 °C to +110 °C (TF 110).
 Specific EEI: 0.17.

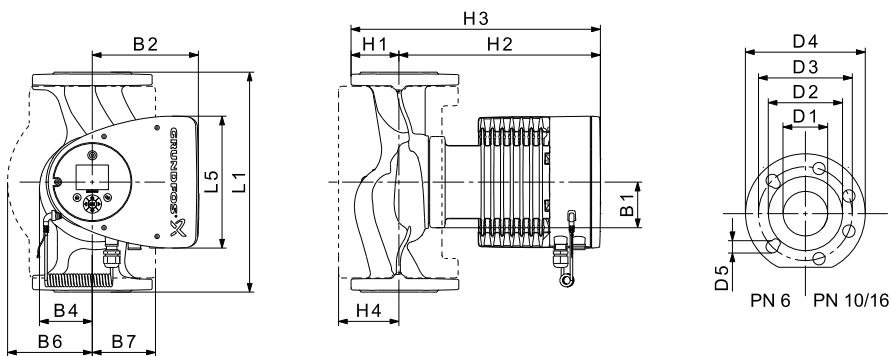

TM05 5291 3612

Pump type	Dimensions [mm]															
	L1	L5	B1	B2	B4	B6	B7	H1	H2	H3	H4	D1	D2	D3	D4	D5
MAGNA3 80-120 F	360	204	84	164	73	163	163	96	318	413	115	80	128	150/160	200	19

For product numbers, see page 106.

MAGNA3 D 80-120 F

1 x 230 V, 50/60 Hz

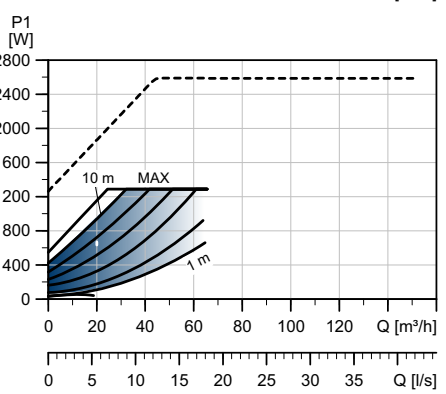
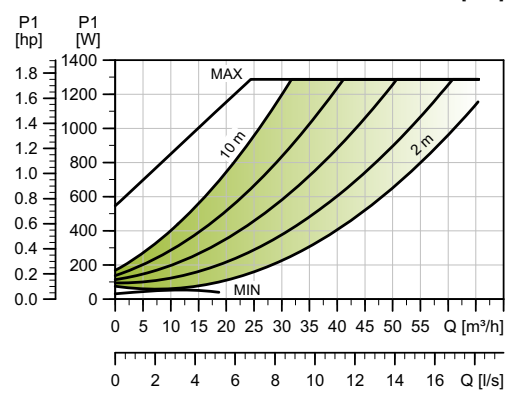
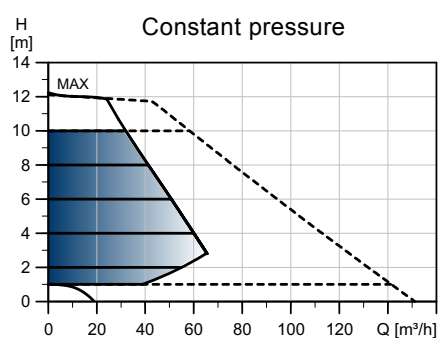
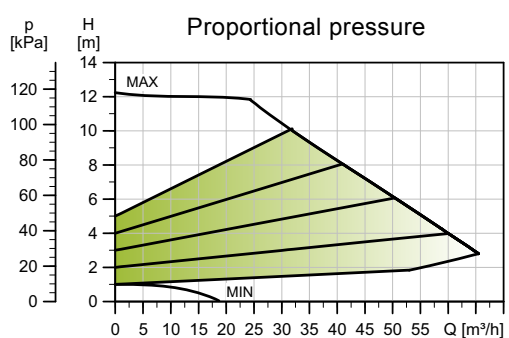

TM05 3781 1912

Speed	P1 [W]	I _{1/1} [A]
Min.	32	0.32
Max.	1313	5.74

The pump incorporates overload protection.

Connections: See Counter flanges, page 39.
 System pressure: Max. 1.0 MPa (10 bar). Also available as max. 1.6 MPa (16 bar).
 Liquid temperature: -10 °C to +110 °C (TF 110).
 Specific EEI: 0.17.

Net weights [kg]	Gross weights [kg]	Ship. vol. [m ³]
51.6	63.1	0.07

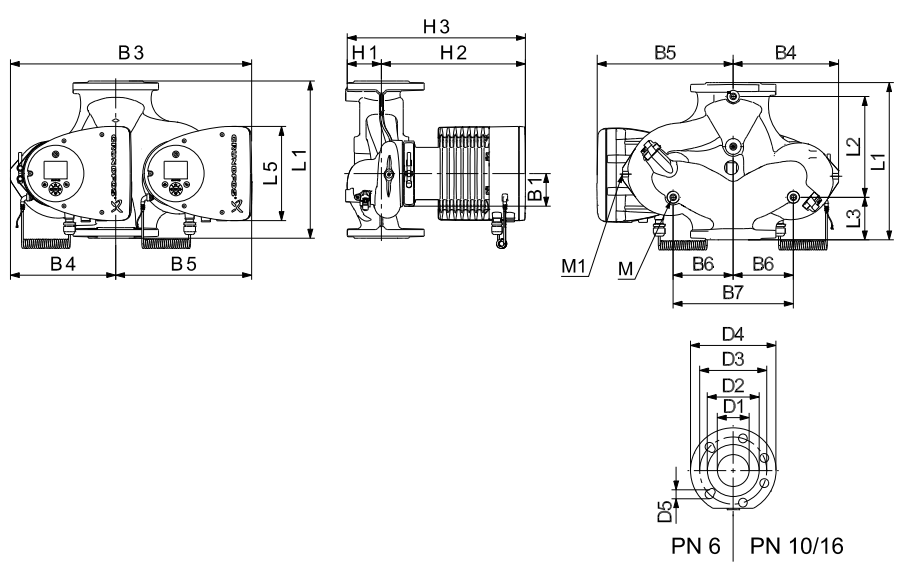

TM05 5366 3612

Pump type	Dimensions [mm]																				
	L1	L2	L3	L4	L5	B1	B3	B4	B5	B6	B7	H1	H2	H3	D1	D2	D3	D4	D5	M	M1
MAGNA3 D 80-120 F	360	218	102	102	204	84	538	244	294	130	260	97	318	415	80	128	150/160	200	19	M12	Rp 1/4

For product numbers, see page 106.

MAGNA3 100-40 F

1 x 230 V, 50/60 Hz

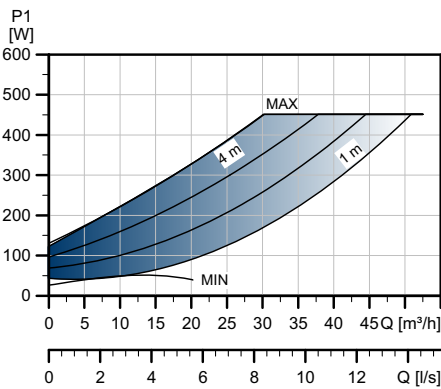
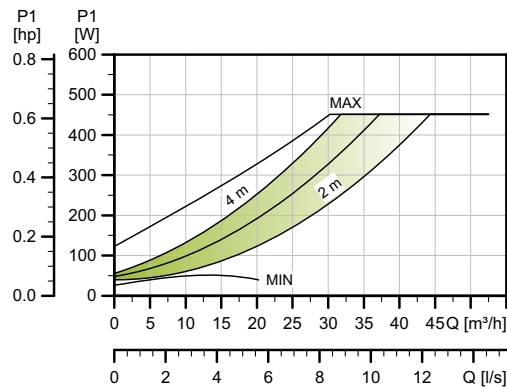
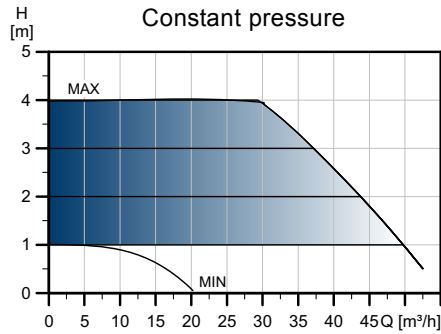
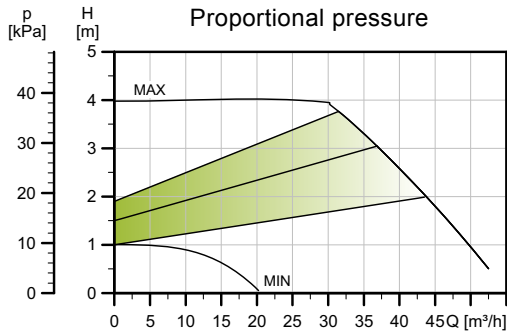

TM05 3757 1912

Speed	P1 [W]	I _{1/1} [A]
Min.	28	0.27
Max.	465	2.06

The pump incorporates overload protection.

Net weights [kg]	Gross weights [kg]	Ship. vol. [m ³]
32.3	36.4	0.1

Connections: See *Counter flanges*, page 39.
 System pressure: Max. 1.0 MPa (10 bar). Also available as max. 1.6 MPa (16 bar).
 Liquid temperature: -10 °C to +110 °C (TF 110).
 Specific EEI: 0.17.

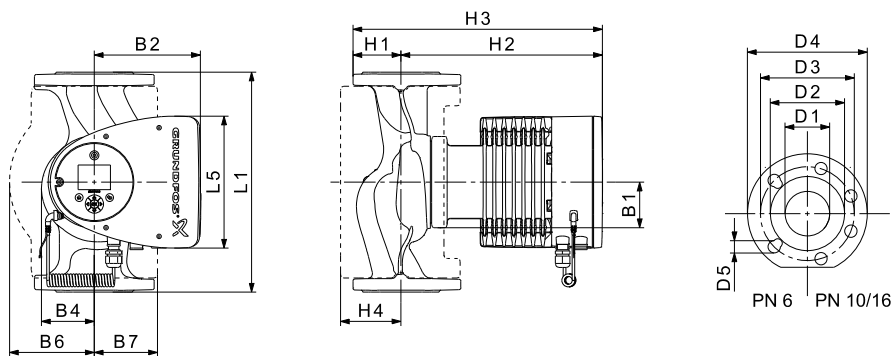

TM05 5291 3612

Pump type	Dimensions [mm]															
	L1	L5	B1	B2	B4	B6	B7	H1	H2	H3	H4	D1	D2	D3	D4	D5
MAGNA3 100-40 F	450	204	84	164	73	178	178	103	330	433	120	100	160	170	220	19

For product numbers, see page 106.

MAGNA3 D 100-40 F

1 x 230 V, 50/60 Hz

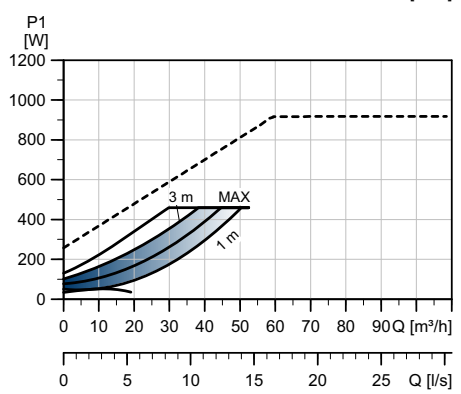
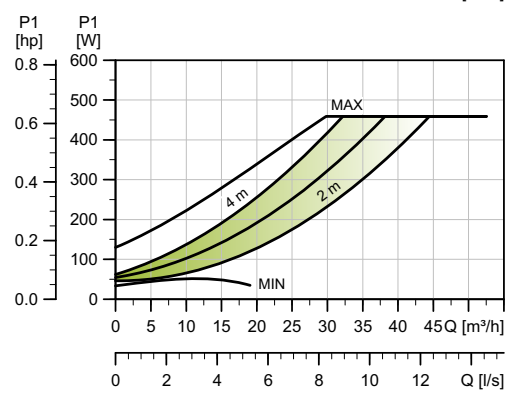
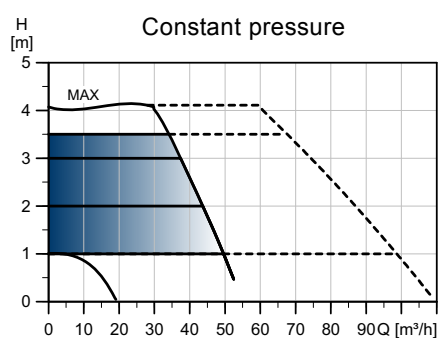
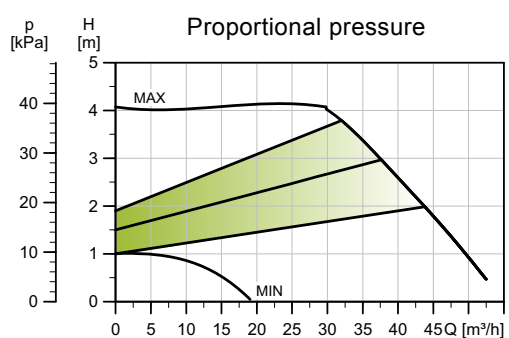

TM05 5366 3612

Speed	P1 [W]	I _{1/1} [A]
Min.	28	0.27
Max.	465	2.06

The pump incorporates overload protection.

Connections: See Counter flanges, page 39.
 System pressure: Max. 1.0 MPa (10 bar). Also available as max. 1.6 MPa (16 bar).
 Liquid temperature: -10 °C to +110 °C (TF 110).
 Specific EEI: 0.19.

Net weights [kg]	Gross weights [kg]	Ship. vol. [m ³]
58.8	71.3	0.1

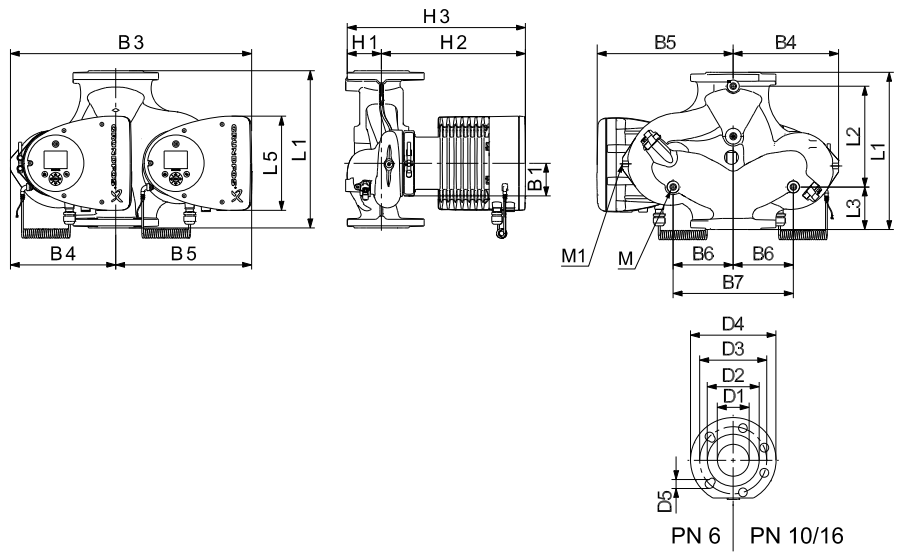

TM05 2205 0412

Pump type	Dimensions [mm]																				
	L1	L2	L3	L4	L5	B1	B3	B4	B5	B6	B7	H1	H2	H3	D1	D2	D3	D4	D5	M	M1
MAGNA3 D 100-40 F	450	243	147	147	204	84	551	252	299	135	270	103	330	434	100	160	170	220	19	M12	Rp 1/4

For product numbers, see page 106.

MAGNA3 100-60 F

1 x 230 V, 50/60 Hz

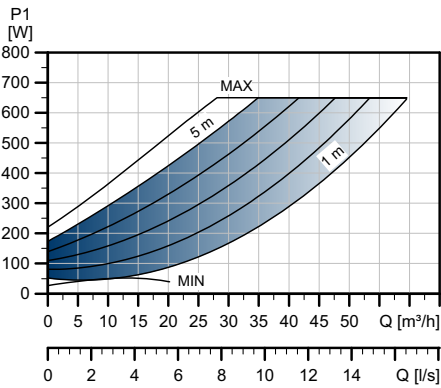
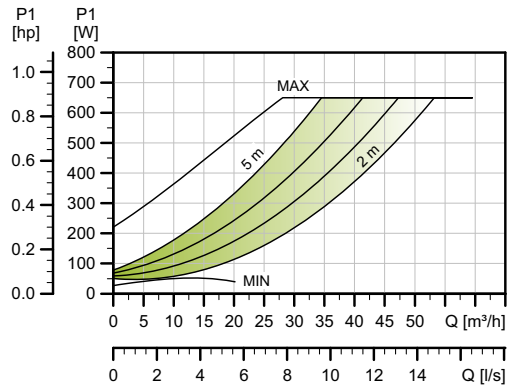
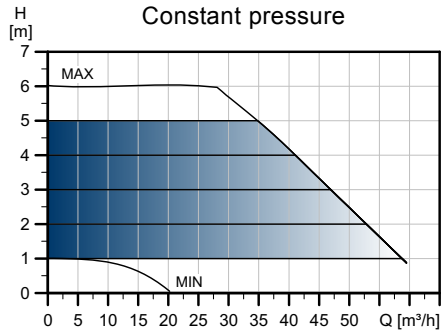
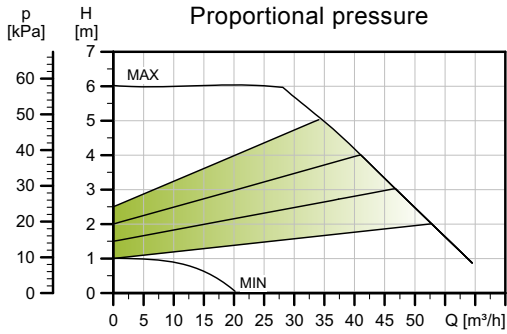

TM05 3758 1912

Speed	P1 [W]	I _{1/1} [A]
Min.	28	0.28
Max.	664	2.94

The pump incorporates overload protection.

Net weights [kg]	Gross weights [kg]	Ship. vol. [m ³]
32.3	36.4	0.1

Connections: See Counter flanges, page 39.
 System pressure: Max. 1.0 MPa (10 bar). Also available as max. 1.6 MPa (16 bar).
 Liquid temperature: -10 °C to +110 °C (TF 110).
 Specific EEI: 0.17.

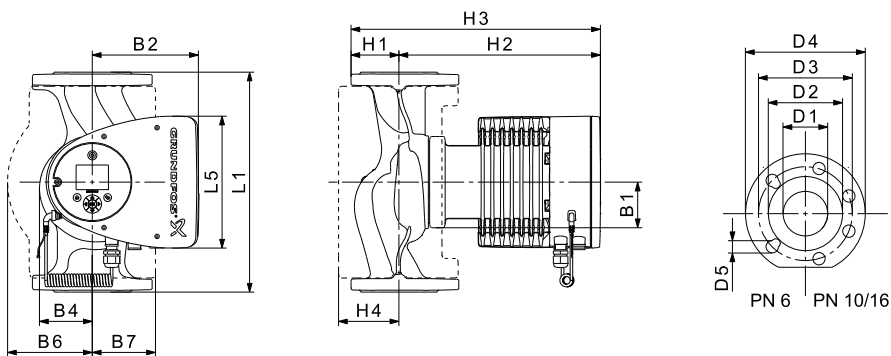

TM05 5291 3612

Pump type	Dimensions [mm]															
	L1	L5	B1	B2	B4	B6	B7	H1	H2	H3	H4	D1	D2	D3	D4	D5
MAGNA3 100-60 F	450	204	84	164	73	178	178	103	330	433	120	100	160	170	220	19

For product numbers, see page 106.

MAGNA3 D 100-60 F

1 x 230 V, 50/60 Hz

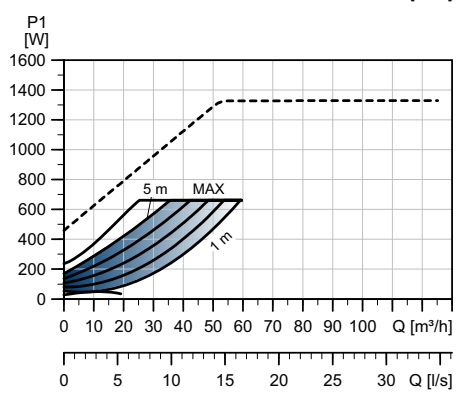
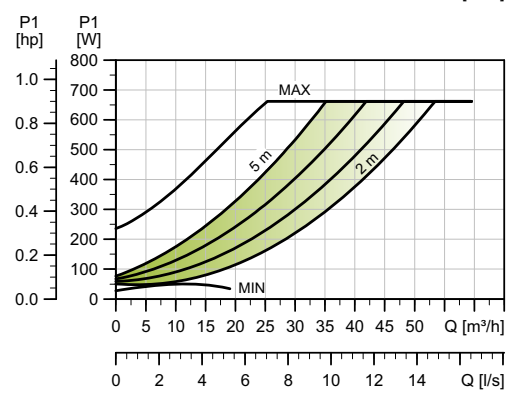
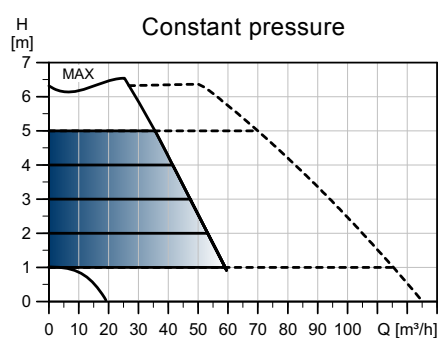
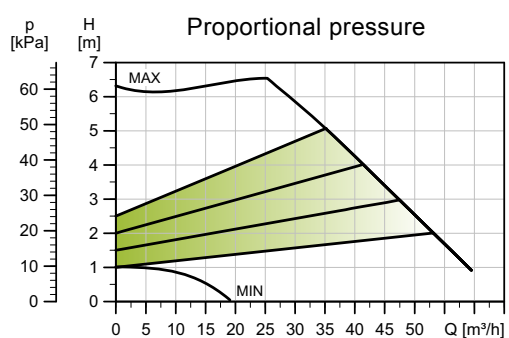

TM05 3783 1912

Speed	P1 [W]	I _{1/1} [A]
Min.	28	0.27
Max.	664	2.94

The pump incorporates overload protection.

Connections: See Counter flanges, page 39.
 System pressure: Max. 1.0 MPa (10 bar). Also available as max. 1.6 MPa (16 bar).
 Liquid temperature: -10 °C to +110 °C (TF 110).
 Specific EEI: 0.18.

Net weights [kg]	Gross weights [kg]	Ship. vol. [m ³]
58.8	71.3	0.1

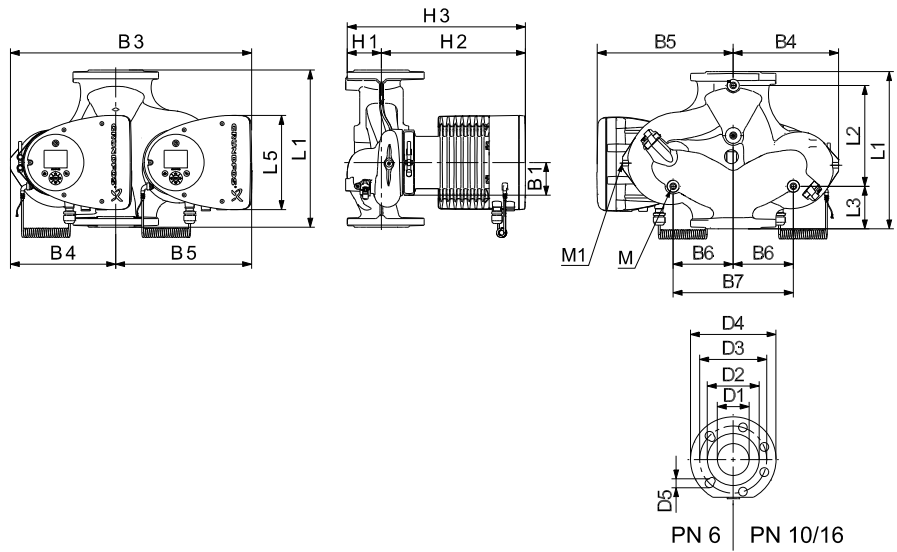

TM05 5366 3612

Pump type	Dimensions [mm]																				
	L1	L2	L3	L4	L5	B1	B3	B4	B5	B6	B7	H1	H2	H3	D1	D2	D3	D4	D5	M	M1
MAGNA3 D 100-60 F	450	243	147	147	204	84	551	252	299	135	270	103	330	434	100	160	170	220	19	M12	Rp 1/4

For product numbers, see page 106.

MAGNA3 100-80 F

1 x 230 V, 50/60 Hz

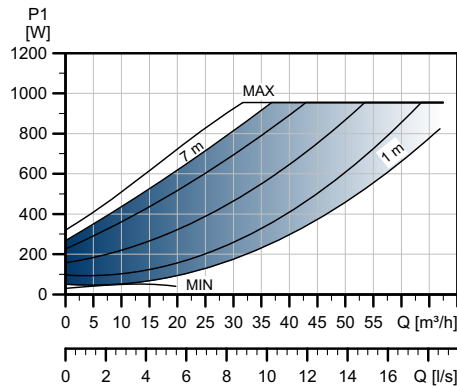
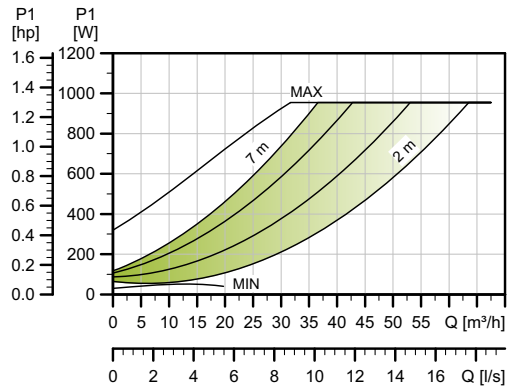
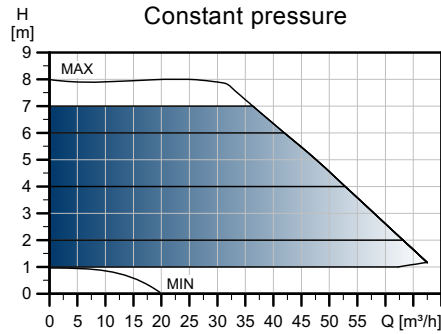
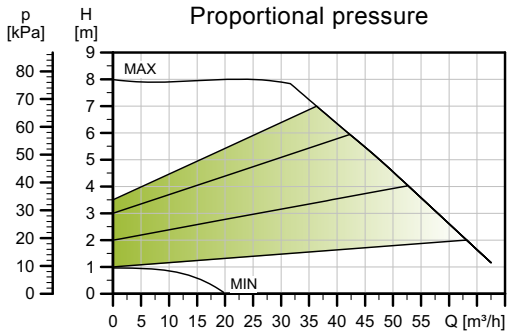

TM05 3759 1912

Speed	P1 [W]	I _{1/1} [A]
Min.	31	0.32
Max.	971	4.31

The pump incorporates overload protection.

Net weights [kg]	Gross weights [kg]	Ship. vol. [m ³]
33.1	37.3	0.1

Connections: See *Counter flanges*, page 39.
 System pressure: Max. 1.0 MPa (10 bar). Also available as max. 1.6 MPa (16 bar).
 Liquid temperature: -10 °C to +110 °C (TF 110).
 Specific EEI: 0.17.

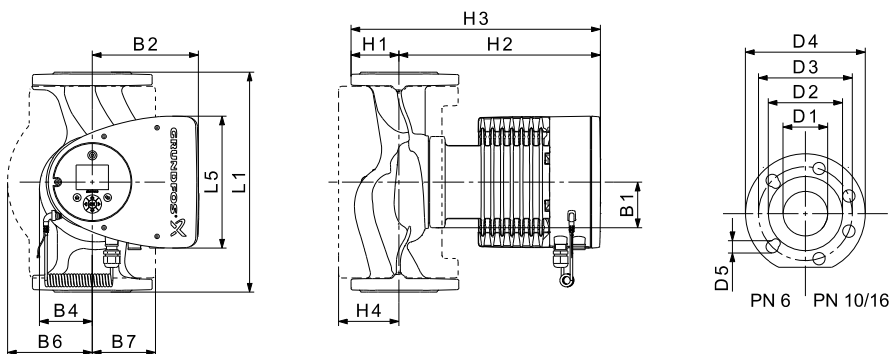

TM05 5291 3612

Pump type	Dimensions [mm]															
	L1	L5	B1	B2	B4	B6	B7	H1	H2	H3	H4	D1	D2	D3	D4	D5
MAGNA3 100-80 F	450	204	84	164	73	178	178	103	330	433	120	100	160	170	220	19

For product numbers, see page 106.

MAGNA3 D 100-80 F

1 x 230 V, 50/60 Hz

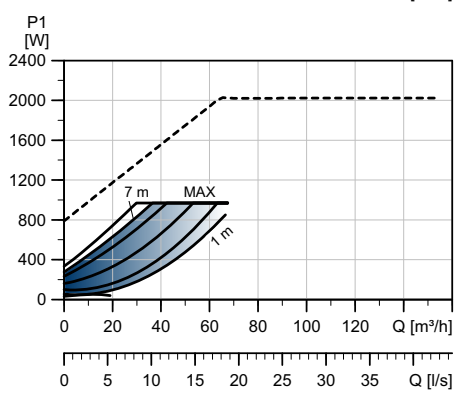
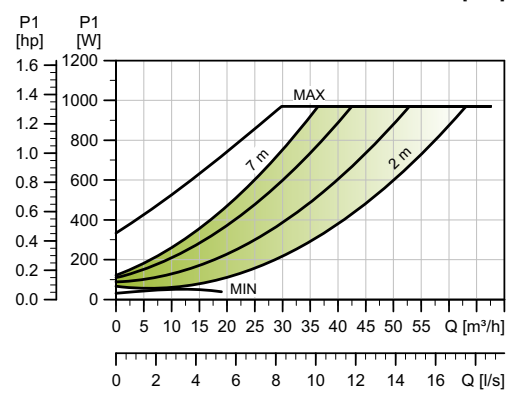
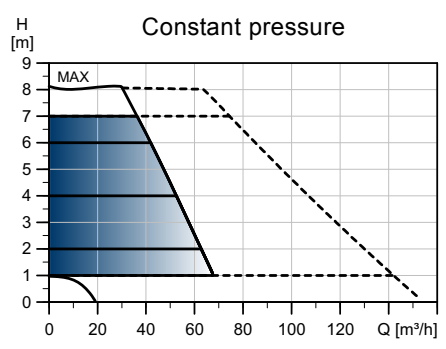
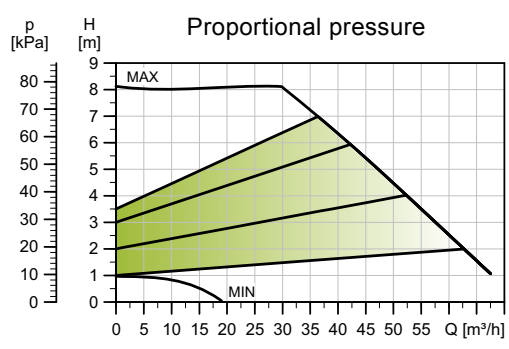

TM05 3784 1912

Speed	P1 [W]	I _{1/1} [A]
Min.	32	0.33
Max.	988	4.36

The pump incorporates overload protection.

Connections: See Counter flanges, page 39.
 System pressure: Max. 1.0 MPa (10 bar). Also available as max. 1.6 MPa (16 bar).
 Liquid temperature: -10 °C to +110 °C (TF 110).
 Specific EEI: 0.17.

Net weights [kg]	Gross weights [kg]	Ship. vol. [m ³]
60.4	73.2	0.1

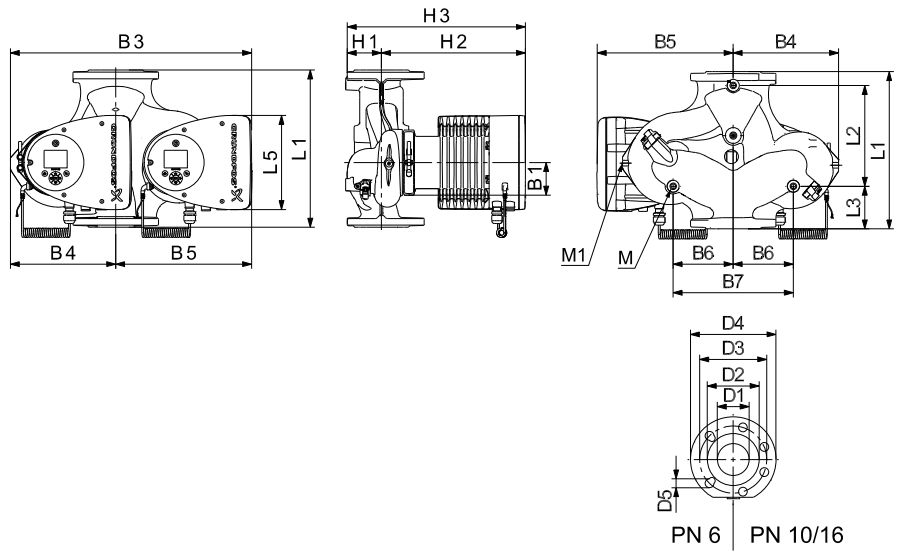

TM05 5366 3612

Pump type	Dimensions [mm]																				
	L1	L2	L3	L4	L5	B1	B3	B4	B5	B6	B7	H1	H2	H3	D1	D2	D3	D4	D5	M	M1
MAGNA3 D 100-80 F	450	243	147	147	204	84	551	252	299	135	270	103	330	434	100	160	170	220	19	M12	Rp 1/4

For product numbers, see page 106.

MAGNA3 100-100 F

1 x 230 V, 50/60 Hz

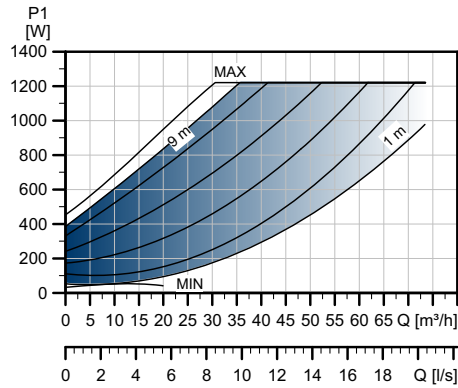
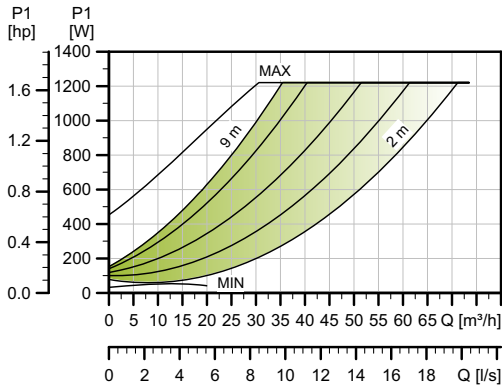
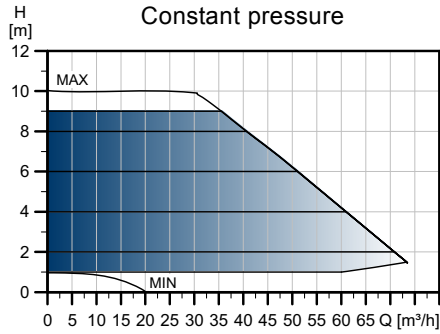
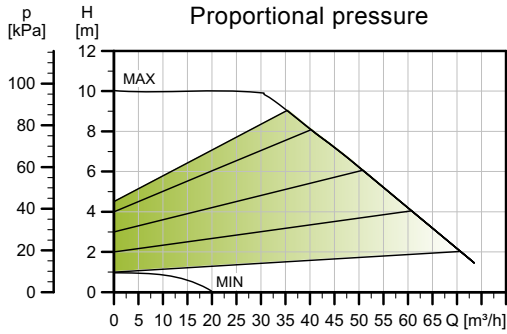

TM05 3760 1912

Speed	P1 [W]	I _{1/1} [A]
Min.	31	0.32
Max.	1244	5.50

The pump incorporates overload protection.

Net weights [kg]	Gross weights [kg]	Ship. vol. [m ³]
33.1	37.0	0.1

Connections: See Counter flanges, page 39.
 System pressure: Max. 1.0 MPa (10 bar). Also available as max. 1.6 MPa (16 bar).
 Liquid temperature: -10 °C to +110 °C (TF 110).
 Specific EEI: 0.17.

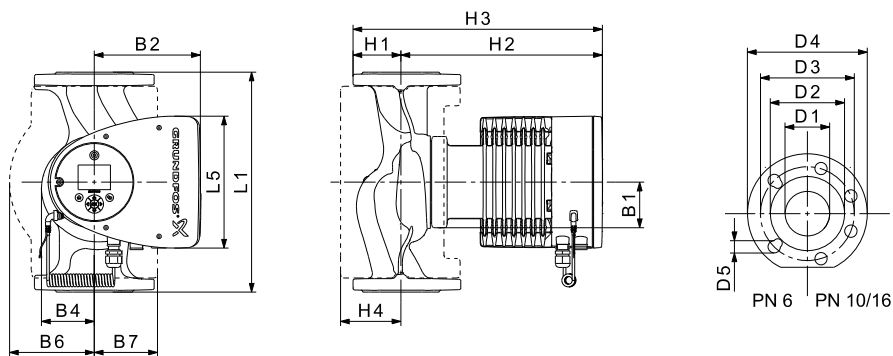

TM05 5291 3612

Pump type	Dimensions [mm]															
	L1	L5	B1	B2	B4	B6	B7	H1	H2	H3	H4	D1	D2	D3	D4	D5
MAGNA3 100-100 F	450	204	84	164	73	178	178	103	330	433	120	100	160	170	220	19

For product numbers, see page 106.

MAGNA3 D 100-100 F

1 x 230 V, 50/60 Hz

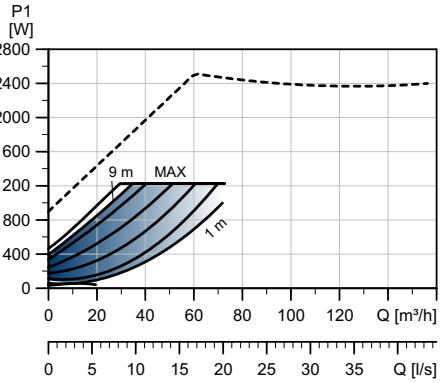
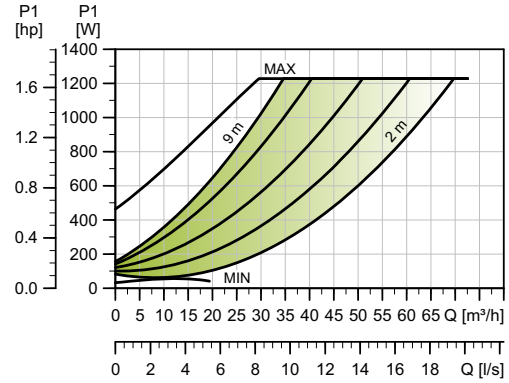
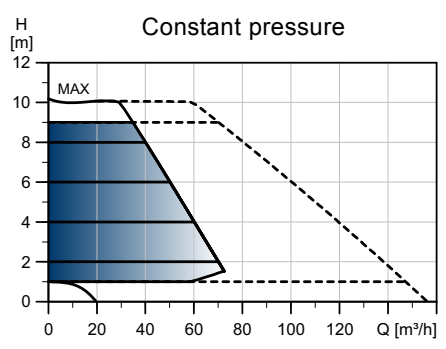
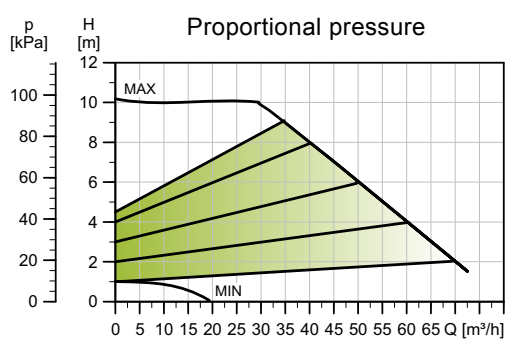

TM05 5366 3612

Speed	P1 [W]	I _{1/1} [A]
Min.	34	0.34
Max.	1249	5.51

The pump incorporates overload protection.

Connections: See Counter flanges, page 39.
 System pressure: Max. 1.0 MPa (10 bar). Also available as max. 1.6 MPa (16 bar).
 Liquid temperature: -10 °C to +110 °C (TF 110).
 Specific EEI: 0.17.

Net weights [kg]	Gross weights [kg]	Ship. vol. [m ³]
60.4	73.2	0.1

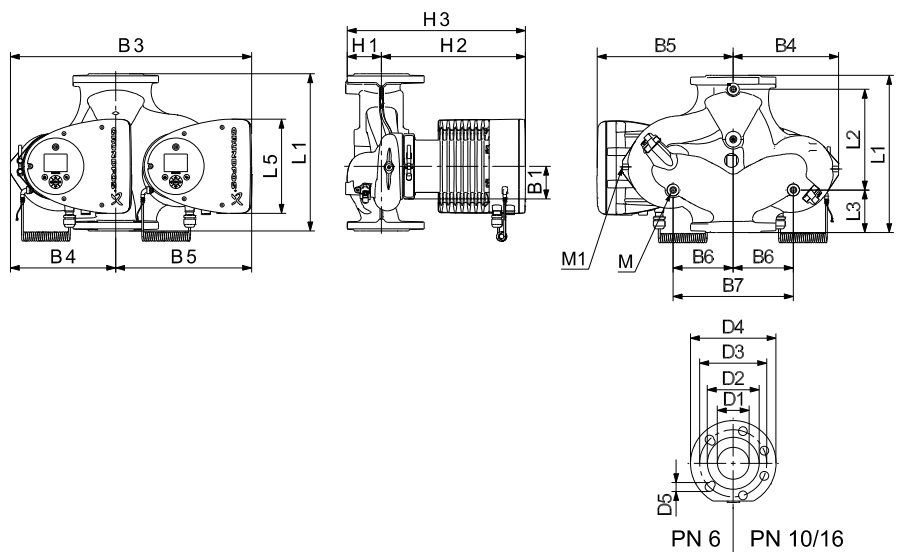

TM05 2205 0412

Pump type	Dimensions [mm]																				
	L1	L2	L3	L4	L5	B1	B3	B4	B5	B6	B7	H1	H2	H3	D1	D2	D3	D4	D5	M	M1
MAGNA3 D 100-100 F	450	243	147	147	204	84	551	252	299	135	270	103	330	434	100	160	170	220	19	M12	Rp 1/4

For product numbers, see page 106.

MAGNA3 100-120 F

1 x 230 V, 50/60 Hz

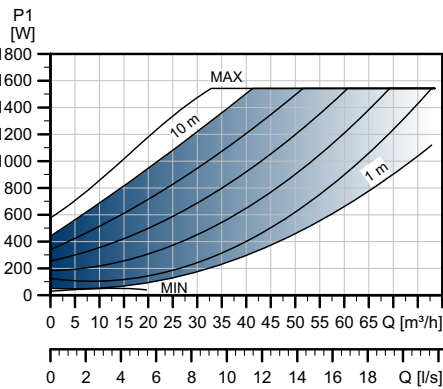
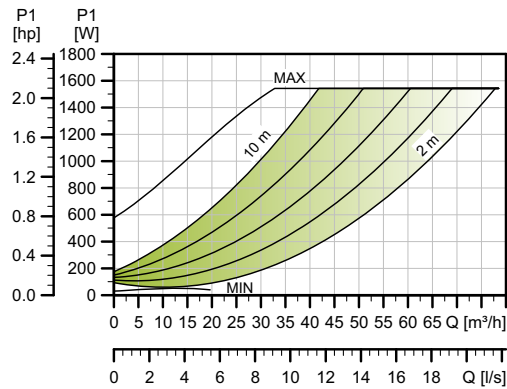
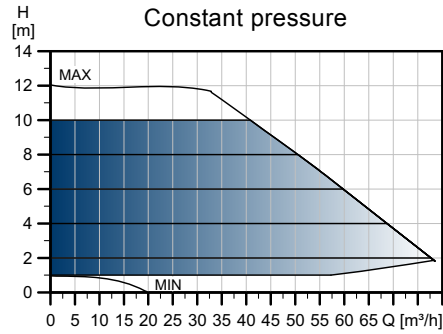
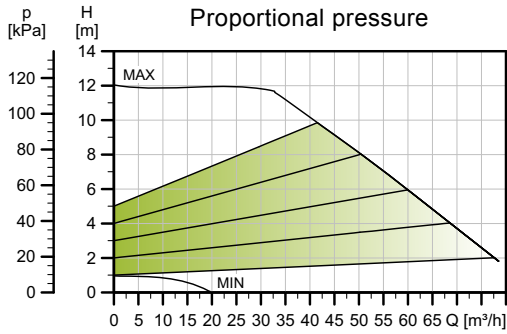

TM05 3761 1912

Speed	P1 [W]	I _{1/1} [A]
Min.	31	0.32
Max.	1576	6.97

The pump incorporates overload protection.

Net weights [kg]	Gross weights [kg]	Ship. vol. [m ³]
33.1	37.0	0.1

Connections: See *Counter flanges*, page 39.
 System pressure: Max. 1.0 MPa (10 bar).
 Also available as max. 1.6 MPa (16 bar).
 Liquid temperature: -10 °C to +110 °C (TF 110).
 Specific EEI: 0.17.

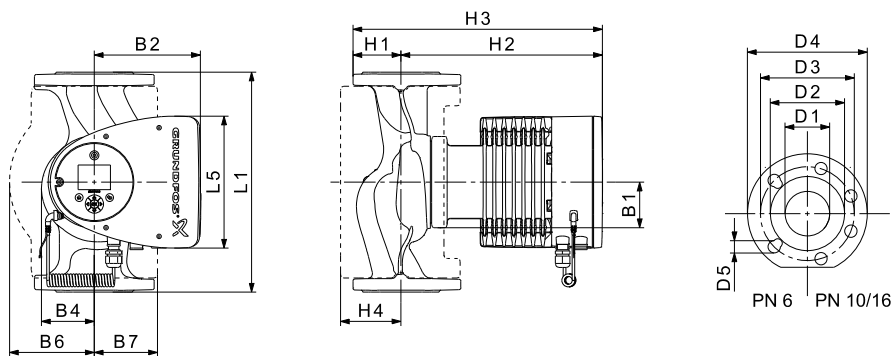

TM05 5291 3612

Pump type	Dimensions [mm]															
	L1	L5	B1	B2	B4	B6	B7	H1	H2	H3	H4	D1	D2	D3	D4	D5
MAGNA3 100-120 F	450	204	84	164	73	178	178	103	330	433	120	100	160	170	220	19

For product numbers, see page 106.

MAGNA3 D 100-120 F

1 x 230 V, 50/60 Hz

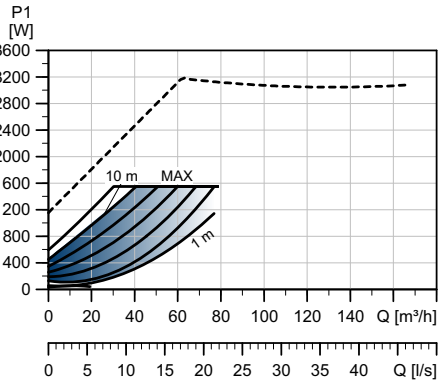
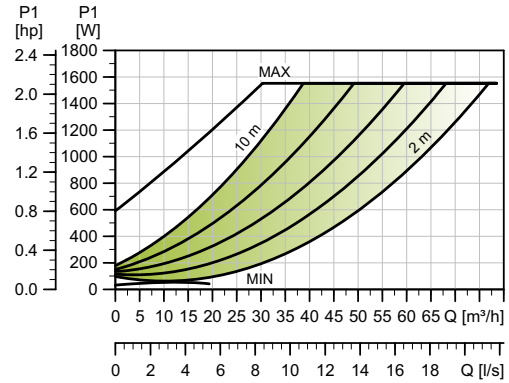
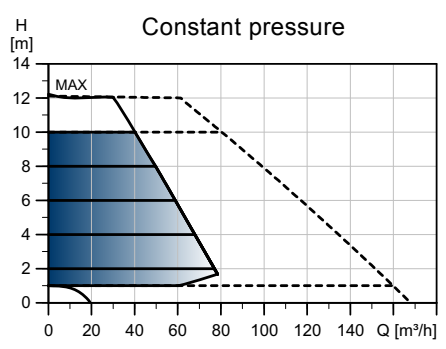
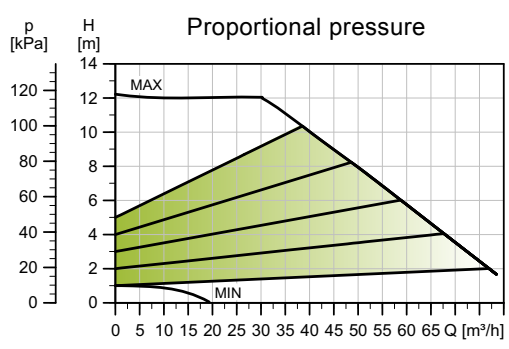

TM05 3786 1912

Speed	P1 [W]	I _{1/1} [A]
Min.	35	0.35
Max.	1582	6.98

The pump incorporates overload protection.

Connections: See Counter flanges, page 39.
 System pressure: Max. 1.0 MPa (10 bar). Also available as max. 1.6 MPa (16 bar).
 Liquid temperature: -10 °C to +110 °C (TF 110).
 Specific EEI: 0.17.

Net weights [kg]	Gross weights [kg]	Ship. vol. [m ³]
60.4	72.8	0.1

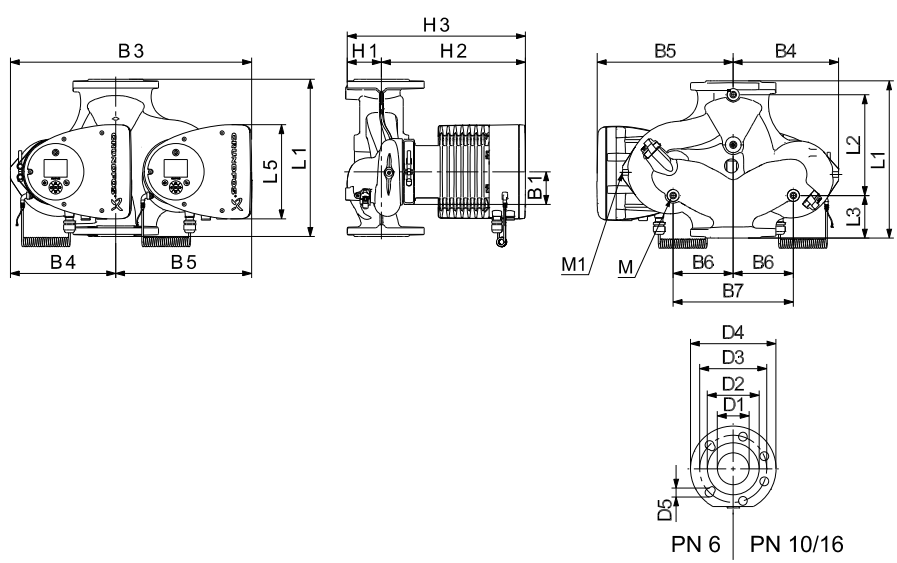

TM05 6366 3612

Pump type	Dimensions [mm]																				
	L1	L2	L3	L4	L5	B1	B3	B4	B5	B6	B7	H1	H2	H3	D1	D2	D3	D4	D5	M	M1
MAGNA3 D 100-120 F	450	243	147	147	204	84	551	252	299	135	270	103	330	434	100	160	170	220	19	M12	Rp 1/4

For product numbers, see page 106.

10. Product numbers

MAGNA3 for the international market

Single-head pump	Port-to-port length [mm]	Cast iron				Stainless steel	Data sheet Page
		PN 6	PN 10	PN 6/10	PN 16	PN 6/10	
MAGNA3 32-120 F (N)	220			97924259	97924265	97924346	48
MAGNA3 40-80 F (N)	220			97924268	97924275	97924349	50
MAGNA3 40-100 F (N)	220			97924269	97924276	97924350	52
MAGNA3 40-120 F (N)	250			97924270	97924277	97924351	54
MAGNA3 40-150 F (N)	250			97924271	97924278	97924352	56
MAGNA3 40-180 F (N)	250			97924272	97924279	97924353	58
MAGNA3 50-40 F (N)	240			97924280	97924287	97924354	60
MAGNA3 50-60 F (N)	240			97924281	97924288	97924355	62
MAGNA3 50-80 F (N)	240			97924282	97924289	97924356	64
MAGNA3 50-100 F (N)	280			97924283	97924290	97924357	66
MAGNA3 50-120 F (N)	280			97924284	97924291	97924358	68
MAGNA3 50-150 F (N)	280			97924285	97924292	97924359	70
MAGNA3 50-180 F (N)	280			97924286	97924293	97924360	72
MAGNA3 65-40 F (N)	340			97924294	97924300	97924361	74
MAGNA3 65-60 F (N)	340			97924295	97924301	97924362	76
MAGNA3 65-80 F (N)	340			97924296	97924302	97924363	78
MAGNA3 65-100 F (N)	340			97924297	97924303	97924364	80
MAGNA3 65-120 F (N)	340			97924298	97924304	97924365	82
MAGNA3 65-150 F (N)	340			97924299	97924305	97924366	84
MAGNA3 80-40 F	360	97924306	97924316		97924326		86
MAGNA3 80-60 F	360	97924307	97924317		97924327		88
MAGNA3 80-80 F	360	97924308	97924318		97924328		90
MAGNA3 80-100 F	360	97924309	97924319		97924329		92
MAGNA3 80-120 F	360	97924310	97924320		97924330		94
MAGNA3 100-40 F	450	97924311	97924321		97924331		96
MAGNA3 100-60 F	450	97924312	97924322		97924332		98
MAGNA3 100-80 F	450	97924313	97924323		97924333		100
MAGNA3 100-100 F	450	97924314	97924324		97924334		102
MAGNA3 100-120 F	450	97924315	97924325		97924335		104

Twin-head pump	Port-to-port length [mm]	Cast iron				Data sheet Page
		PN 6	PN 10	PN 6/10	PN 16	
MAGNA3 D 32-120 F	220			97924454	97924460	49
MAGNA3 D 40-80 F	220			97924463	97924470	51
MAGNA3 D 40-100 F	220			97924464	97924471	53
MAGNA3 D 40-120 F	250			97924465	97924472	55
MAGNA3 D 40-150 F	250			97924466	97924473	57
MAGNA3 D 40-180 F	250			97924467	97924474	59
MAGNA3 D 50-40 F	240			97924475	97924482	61
MAGNA3 D 50-60 F	240			97924476	97924483	63
MAGNA3 D 50-80 F	240			97924477	97924484	65
MAGNA3 D 50-100 F	280			97924478	97924485	67
MAGNA3 D 50-120 F	280			97924479	97924486	69
MAGNA3 D 50-150 F	280			97924480	97924487	71
MAGNA3 D 50-180 F	280			97924481	97924488	73
MAGNA3 D 65-40 F	340			97924489	97924495	75
MAGNA3 D 65-60 F	340			97924490	97924496	77
MAGNA3 D 65-80 F	340			97924491	97924497	79
MAGNA3 D 65-100 F	340			97924492	97924498	81
MAGNA3 D 65-120 F	340			97924493	97924499	83
MAGNA3 D 65-150 F	340			97924494	97924500	85
MAGNA3 D 80-40 F	360	97924501	97924511		97924521	87
MAGNA3 D 80-60 F	360	97924502	97924512		97924522	89
MAGNA3 D 80-80 F	360	97924503	97924513		97924523	91
MAGNA3 D 80-100 F	360	97924504	97924514		97924524	93
MAGNA3 D 80-120 F	360	97924505	97924515		97924525	95
MAGNA3 D 100-40 F	450	97924506	97924516		97924526	97
MAGNA3 D 100-60 F	450	97924507	97924517		97924527	99
MAGNA3 D 100-80 F	450	97924508	97924518		97924528	101
MAGNA3 D 100-100 F	450	97924509	97924519		97924529	103
MAGNA3 D 100-120 F	450	97924510	97924520		97924530	105

MAGNA3 for the German market

Single-head pump	Port-to-port length [mm]	Cast iron				Stainless steel	Data sheet Page
		PN 6	PN 10	PN 6/10	PN 16	PN 6/10	
MAGNA3 32-120 F (N)	220			97924638	97924644	97924726	48
MAGNA3 40-80 F (N)	220			97924647	97924654	97924729	50
MAGNA3 40-100 F (N)	220			97924648	97924655	97924730	52
MAGNA3 40-120 F (N)	250			97924649	97924656	97924731	54
MAGNA3 40-150 F (N)	250			97924650	97924657	97924732	56
MAGNA3 40-180 F (N)	250			97924651	97924658	97924733	58
MAGNA3 50-40 F (N)	240			97924659	97924666	97924734	60
MAGNA3 50-60 F (N)	240			97924660	97924668	97924735	62
MAGNA3 50-80 F (N)	240			97924661	97924669	97924736	64
MAGNA3 50-100 F (N)	280			97924662	97924670	97924737	66
MAGNA3 50-120 F (N)	280			97924663	97924671	97924738	68
MAGNA3 50-150 F (N)	280			97924664	97924672	97924739	70
MAGNA3 50-180 F (N)	280			97924665	97924673	97924740	72
MAGNA3 65-40 F (N)	340			97924674	97924680	97924741	74
MAGNA3 65-60 F (N)	340			97924675	97924681	97924742	76
MAGNA3 65-80 F (N)	340			97924676	97924682	97924743	78
MAGNA3 65-100 F (N)	340			97924677	97924683	97924744	80
MAGNA3 65-120 F (N)	340			97924678	97924684	97924745	82
MAGNA3 65-150 F (N)	340			97924679	97924685	97924746	84
MAGNA3 80-40 F	360	97924686	97924696		97924706		86
MAGNA3 80-60 F	360	97924687	97924697		97924707		88
MAGNA3 80-80 F	360	97924688	97924698		97924708		90
MAGNA3 80-100 F	360	97924689	97924699		97924709		92
MAGNA3 80-120 F	360	97924690	97924700		97924710		94
MAGNA3 100-40 F	450	97924691	97924701		97924711		96
MAGNA3 100-60 F	450	97924692	97924702		97924712		98
MAGNA3 100-80 F	450	97924693	97924703		97924713		100
MAGNA3 100-100 F	450	97924694	97924704		97924714		102
MAGNA3 100-120 F	450	97924695	97924705		97924715		104

Twin-head pump	Port-to-port length [mm]	Cast iron				Data sheet Page
		PN 6	PN 10	PN 6/10	PN 16	
MAGNA3 D 32-120 F	220			97924834	97924840	49
MAGNA3 D 40-80 F	220			97924843	97924850	51
MAGNA3 D 40-100 F	220			97924844	97924851	53
MAGNA3 D 40-120 F	250			97924845	97924852	55
MAGNA3 D 40-150 F	250			97924846	97924853	57
MAGNA3 D 40-180 F	250			97924847	97924854	59
MAGNA3 D 50-40 F	240			97924855	97924862	61
MAGNA3 D 50-60 F	240			97924856	97924863	63
MAGNA3 D 50-80 F	240			97924857	97924864	65
MAGNA3 D 50-100 F	280			97924858	97924865	67
MAGNA3 D 50-120 F	280			97924859	97924866	69
MAGNA3 D 50-150 F	280			97924860	97924867	71
MAGNA3 D 50-180 F	280			97924861	97924868	73
MAGNA3 D 65-40 F	340			97924869	97924875	75
MAGNA3 D 65-60 F	340			97924870	97924876	77
MAGNA3 D 65-80 F	340			97924871	97924877	79
MAGNA3 D 65-100 F	340			97924872	97924878	81
MAGNA3 D 65-120 F	340			97924873	97924879	83
MAGNA3 D 65-150 F	340			97924874	97924880	85
MAGNA3 D 80-40 F	360	97924881	97924891		97924901	87
MAGNA3 D 80-60 F	360	97924882	97924892		97924902	89
MAGNA3 D 80-80 F	360	97924883	97924893		97924903	91
MAGNA3 D 80-100 F	360	97924884	97924894		97924904	93
MAGNA3 D 80-120 F	360	97924885	97924895		97924905	95
MAGNA3 D 100-40 F	450	97924886	97924896		97924906	97
MAGNA3 D 100-60 F	450	97924887	97924897		97924907	99
MAGNA3 D 100-80 F	450	97924888	97924898		97924908	101
MAGNA3 D 100-100 F	450	97924889	97924899		97924909	103
MAGNA3 D 100-120 F	450	97924890	97924900		97924910	105

11. Further product information

WebCAPS

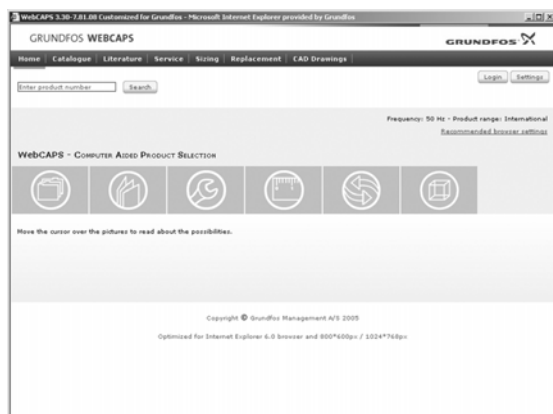

WebCAPS is a **Web-based Computer Aided Product Selection** program available on www.grundfos.com.

WebCAPS contains detailed information on more than 220,000 grundfos products in more than 30 languages.

Information in WebCAPS is divided into six sections:

- Catalogue
- Literature
- Service
- Sizing
- Replacement
- CAD drawings.

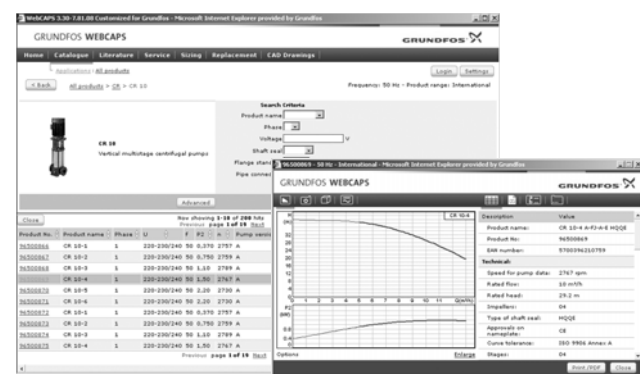

Catalogue

Based on fields of application and pump types, this section contains the following:

- technical data
- curves (QH, Eta, P1, P2, etc.) which can be adapted to the density and viscosity of the pumped liquid and show the number of pumps in operation
- product photos
- dimensional drawings
- wiring diagrams
- quotation texts, etc.

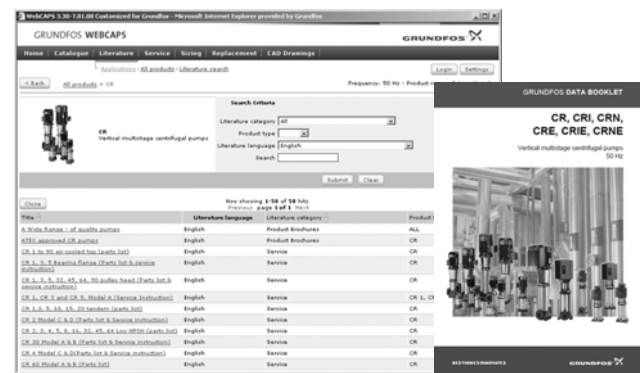

Literature

This section contains all the latest documents of a given pump, such as

- data booklets
- installation and operating instructions
- service documentation, such as Service kit catalogue and Service kit instructions
- quick guides
- product brochures.



Service

This section contains an easy-to-use interactive service catalogue. Here you can find and identify service parts of both existing and discontinued grundfos pumps. Furthermore, the section contains service videos showing you how to replace service parts.

GO CAPS

Mobile solution for professionals on the GO!



CAPS functionality on the mobile workplace.



Subject to alterations.

98091809 1012

ECM: 1101247

The name Grundfos, the Grundfos logo, and the payoff Be-Think-Innovate are registered trademarks owned by Grundfos Management A/S or Grundfos A/S, Denmark. All rights reserved worldwide.