

Note that all unique customer requirements (i.e tolerance) need to be verified thru Alfa Laval.

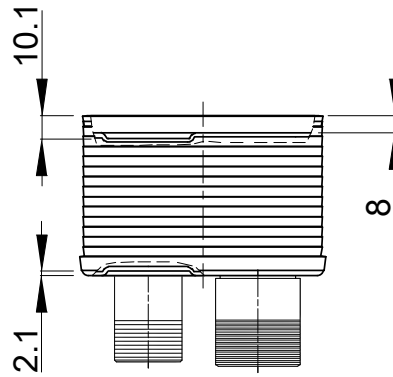
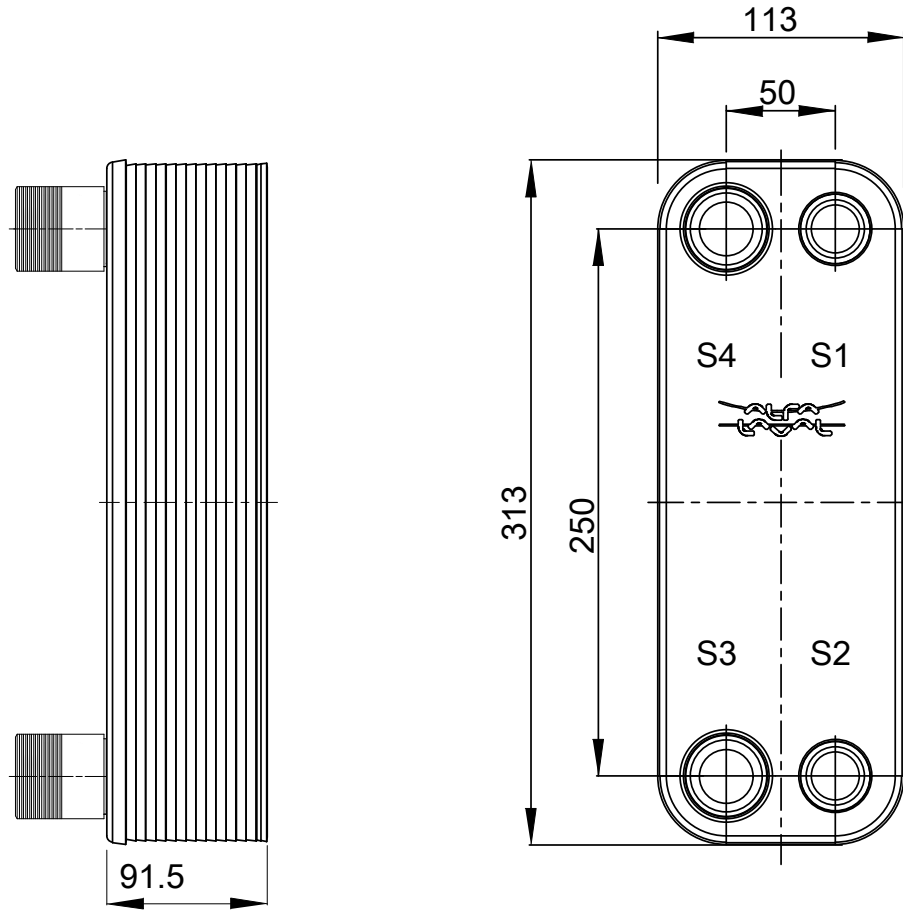
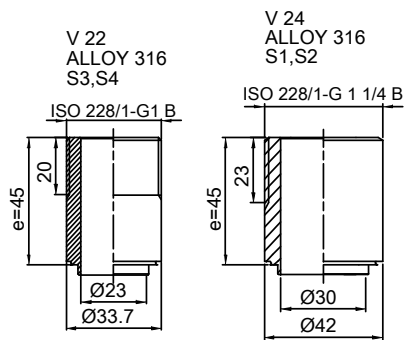

HEATING SURFACE m²
 NETWEIGHT 5.7 kg
 OPERATING WEIGHT kg
 PLATE MATERIAL ALLOY 316
 PLATE GROUPING 1*16H/1*17H

T1 T2 T3 T4 locations on back side correspond to S1 S2 S3 S4 on front side

ALL DIMENSIONS IN MILLIMETERS

SIDE	MEDIA	INLET	TEMP. °C	OUTLET	TEMP. °C	FLOW RATE	PRESSURE DROP	LIQUID VOL.
1	Water	S1	°C	S2	°C	kg/h	kPa	0.9 dm ³
2	Water	S3	°C	S4	°C	kg/h	kPa	0.9 dm ³

PRESSURE VESSEL APPROVAL

PED

CB30-34H (3287083363)

www.alfalaval.com

CUSTOMER NAME / REF. NO.

TOTAL LENGTH 137 mm
 TOTAL WIDTH 113 mm
 TOTAL HEIGHT 313 mm

COMPANY / REF.
 Alfa Laval Nordic AB

4/23/2019
 REV 0