

Alternative 1

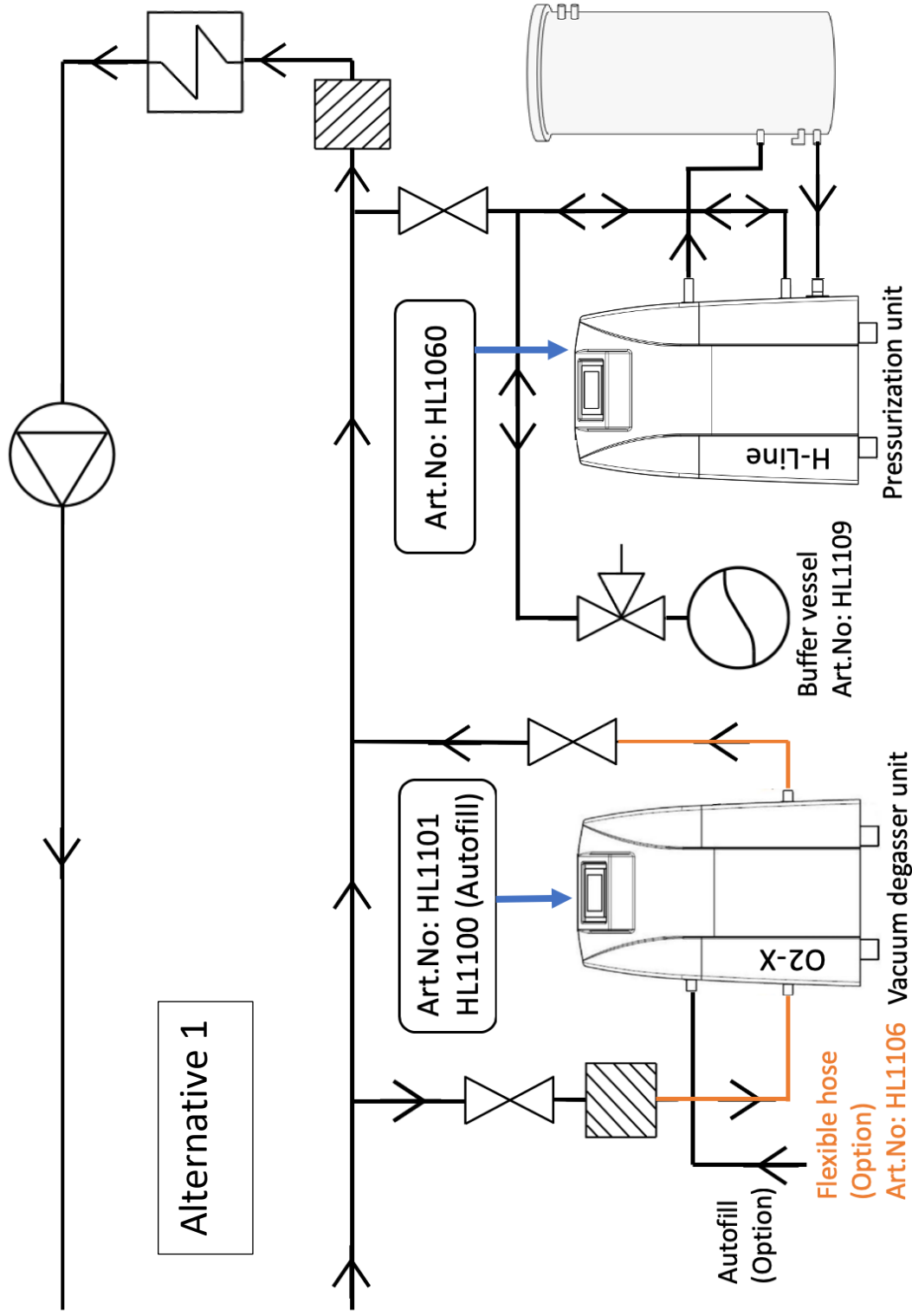

Art.No: HL1106 Vacuum degasser unit

Buffer vessel  
Art.No: HL1109

Pressurization unit

Alternative 2

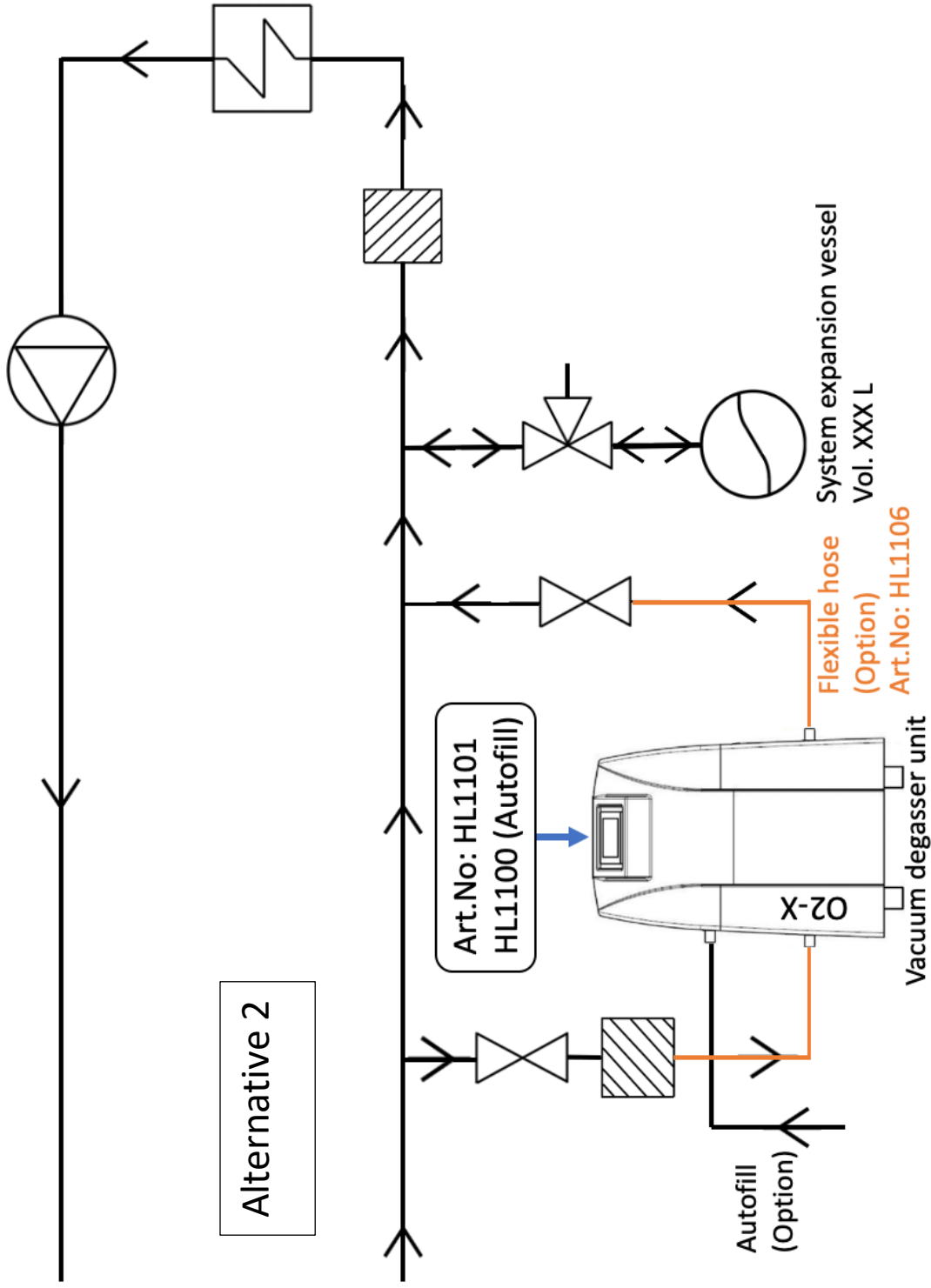



Vacuum degasser unit

Flexible hose  
(Option)  
Art.No: HL1106

System expansion vessel  
Vol. XXX L

Autofill  
(Option)

  MAX 70°C  
 0,7- 4 Bar

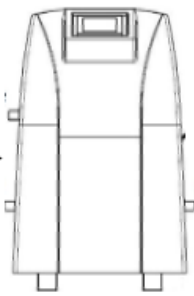

## QUICK GUIDE

**Note!** Please read the user manual and installation guide before installation.

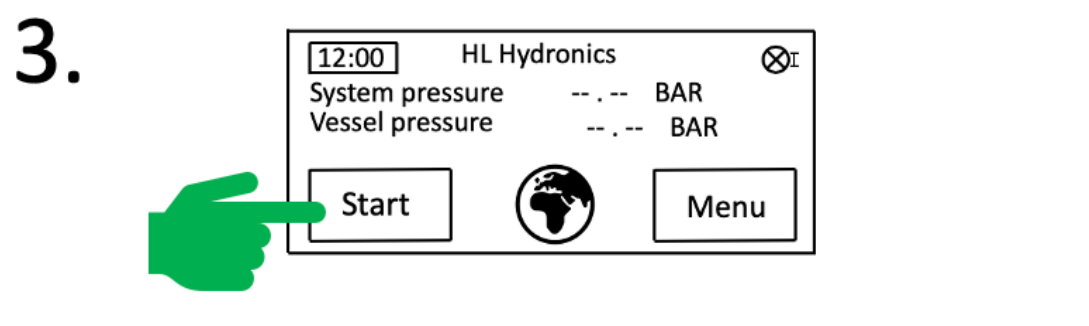
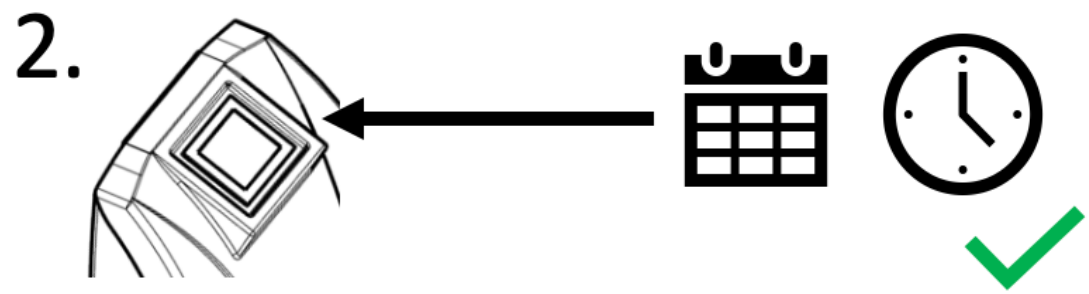
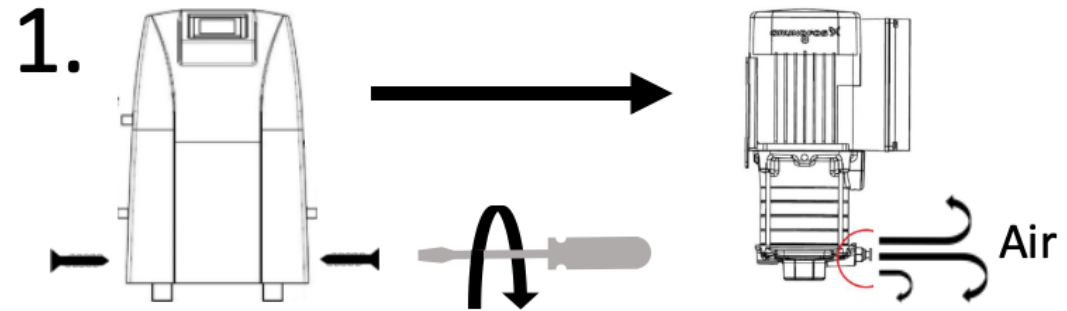

MIN 500 mm

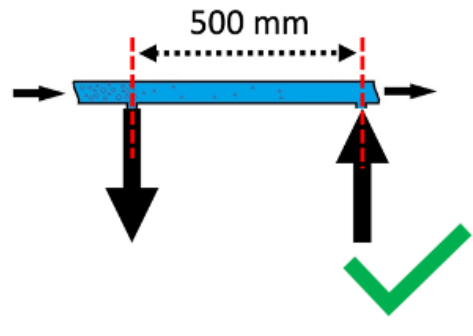
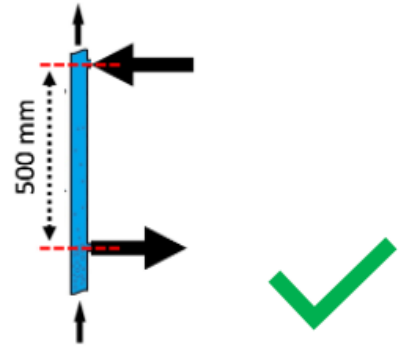
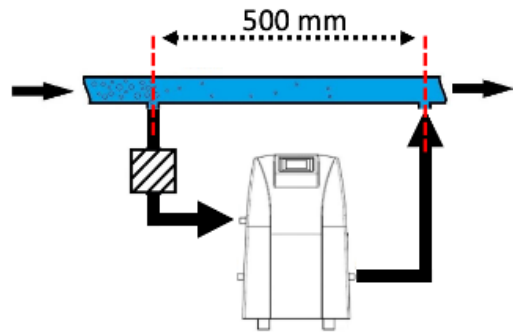

Art.No: HL1107

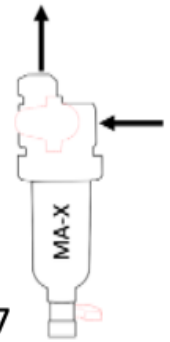

Art.No: HL1108

